

KOGANEI

Desktop Type

**Compressor
Vacuum Pump
Air Tank**

Instruction Manual Ver. 1.0

Thank you very much for purchasing a Koganei desktop type compressor, vacuum pump, and air tank.

To use these products safely and correctly, read this instruction manual before you use them to fully understand the products and to use them correctly.

Keep this instruction manual at hand after you have read it.

Content





1. Safety Precautions	2
2. Models	4
3. Names of Parts	4
4. Installation	5
5. Wiring	5
6. Piping	6
7. Operation	7
8. Draining Condensate	7
9. Specifications	8
10. Performance Graphs	8
11. Dimensions	9
12. Warranty and Repairs	11

1. Safety Precautions

Be sure to read these precautions carefully before use.

Before selecting and using models, please read all the Safety Precautions carefully to ensure proper product use. The Safety Precautions shown below are to help you use the product safely and correctly, and to prevent injury or damage to assets. Be sure to fully comply with the safety regulations specified in ISO 4414 (Pneumatic fluid power—General rules and safety requirements for systems and their components) and JIS B 8370 (General rules for pneumatic systems).

The directions are ranked according to degree of potential danger or damage: “DANGER”, “WARNING”, “CAUTION”, and “ATTENTION”.

 DANGER	Indicates a clear foreseeable danger. Failure to avoid the hazards indicated may result in death or serious injury. Or, damage to or destruction of property.
 WARNING	Indicates a situation in which there is no immediate danger, but the circumstances create a risk. Failure to avoid the hazards indicated may result in death or serious injury. Or, damage to or destruction of property.
 CAUTION	Indicates a situation in which there is no immediate danger, but the circumstances create a risk. Failure to avoid the hazards indicated may result in minor or moderate injury. Or, damage to or destruction of property.
 ATTENTION	Although there is no possibility of injury, etc., this information should be followed to ensure proper use of the product.

These products are designed and manufactured as parts for use in general industrial machinery.

- When selecting and handling this equipment, be sure that the system designer or other personnel with sufficient knowledge and experience read the “Safety Precautions”, catalogs, instruction manual, and other relevant documents before handling the equipment. It is dangerous if handled incorrectly.
- The customer is responsible for verifying and determining the compatibility of the product with the customer's system.
- After reading these materials, always store them where they are easily available for reference by users of the product.
- If the product is transferred or loaned, please be sure to attach the “Instruction Manual” to the product in a conspicuous place so that the new owner will know how to use the product safely and correctly.
- The danger, warning, and caution items listed under these “Safety Precautions” do not cover all possible cases. Read the Catalog and Owner's Manual carefully, and always keep safety first.

 **DANGER**

- Do not use the product for the following applications:
 1. Medical equipment related to maintenance or management of human lives or bodies
 2. Mechanical devices or equipment designed for the purpose of moving or transporting people
 3. Critical safety components in mechanical devices

This product is not intended or designed for applications requiring a high level of safety. There is a risk of loss of life.
- Do not use this product in locations where hazardous materials such as flammable or combustible substances are present. The product is not explosion-proof. There is a possibility of ignition and fire.
- Always install the unit on a firm, level, and flat surface with sufficient work space. There is a risk of injury due to the product tipping over, falling, or malfunctioning.
- Any person who uses a pacemaker or other device should not approach within 1 m [3.280 ft] of the product. The magnetic field from the powerful magnets inside the product may cause a pacemaker to malfunction.
- Never attempt to modify the product. Doing so may result in abnormal operation, causing injury, electric shock, or fire.
- Never attempt inappropriate disassembly or assembly of the product relating to its basic configuration, or its performance or functions. Doing so may result in injury, electric shock, or fire.
- Do not expose the product to water. Exposing the product to water, washing it, or using it underwater may result in abnormal operation, causing injury, electric shock, or fire.
- Do not perform any adjustments to the internal or attached mechanisms (such as connecting or disconnecting wiring connectors, adjusting pressure switches, or removing tubing or sealing plugs) while the product is operating. Abnormal operation may cause injury.

 **WARNING**

- Do not use the product outside its specified operating range. Use outside the specified range may result in product malfunction, failure, or damage. It may also significantly reduce product service life.
- Before supplying power to or operating the product, always check that the operating range is safe. Supplying electricity unintentionally or without confirmation may cause electric shock or injury due to contact with moving parts.
- Do not touch the terminals while the power is on. Doing so may result in electric shock or abnormal operation.

- If you hear unusual noises or notice excessive vibration, stop operation immediately. Continuing to use the product under these conditions may cause damage to the product, abnormal operation due to malfunction, or runaway operation.
- Do not throw the product into a fire. The product may rupture or generate toxic fumes.
- Do not stand, climb, or place heavy objects on the product. Doing so may result in an accident due to falling, injury due to the product falling or being dropped, damage to the product, malfunction due to damage, or runaway operation.
- Before performing maintenance, inspection, servicing, or replacement of parts on the product, always disconnect the power supply and completely shut off all connections to air or vacuum pressure, and confirm that the pressure inside the product and connected piping has returned to atmospheric pressure before proceeding. Note that there is residual pressure in the air storage tank inside the product. If residual pressure remains inside the product, compressed air may be unexpectedly released and cause injury.
- If using the product in any of the locations below, ensure sufficient shielding measures are implemented. Failure to do so can cause malfunction, which can result in equipment damage or injury.
 1. Locations where large electric currents or strong magnetic fields are present
 2. Locations where noise is generated by static electricity or other sources
 3. Locations where there is a possibility of exposure to radiation
- Use safety circuits or system designs to prevent damage to machinery or injury to personnel, etc. when the machine is shut down abnormally due to emergency stop or power failure.
- Apply the specified voltage to the product correctly. Applying the wrong voltage may result in failure of the specified functions and damage or burnout of the product itself.
- If the product is used infrequently (intervals exceeding 30 days), may cause sliding parts to stick, which may lead to delayed operation or sudden movements, potentially resulting in injury. To ensure proper function, perform a test operation at least once every 30 days to check for normal operation.
- Do not use the AC adapter (with power cable) near power lines where large currents flow, or in areas where strong magnetic fields or surges are generated. Doing so can cause unintended operation.
- Do not damage lead wires or other cords. Damaging, forcibly bending, pulling, twisting, placing heavy objects on, or pinching the cords may cause fire, electric shock, or malfunction due to short-circuiting or poor continuity.

- Perform wiring and piping of the product correctly by referring to this catalog and other technical documentation as needed. Incorrect wiring or piping may result in malfunction of actuators or other equipment.
- Do not use the product in locations such as seashores under direct sunlight, near mercury lamps, or close to equipment that generates ozone. Ozone can cause rubber components to deteriorate, leading to reduced performance, malfunction, or complete failure.
- If the equipment is operated for the first time after 48 hours of inactivity or storage, the sliding parts may stick, which may lead to delayed operation or sudden movements. When starting operation after such a pause, perform a test operation to confirm normal operation before use.
- Because our products can be used under a wide variety of conditions, decisions concerning conformance with a particular system should be made upon the careful evaluation by the person in charge of system design. Assurances concerning expected system performance and safety are the responsibility of the designer who decides system conformity. Please fully review and evaluate the specifications using the latest catalogs and technical data, and be sure to consider the possibility of machine breakdown, and to configure a system that ensures safety and reliability, such as by using fail-safes.
- Do not use the product in locations exposed to direct sunlight (ultraviolet rays), areas with dust, salt, or iron powder, or environments with high humidity, organic solvents, phosphate ester hydraulic fluids, sulfur dioxide gas, chlorine gas, acids, or similar substances in the fluid or atmosphere. This may cause temporary malfunctions, a sudden decline in performance, or a reduction in service life.

CAUTION

- Please ensure sufficient workspace is provided when installing the product. Without adequate workspace, routine inspections and maintenance cannot be performed, which may lead to equipment shutdown or product damage.
- Do not use the product in environments containing corrosive gases, flammable gas, or flammable liquids, etc. Such conditions may cause rusting and deterioration of strength, or pose a risk of ignition or explosion due to the motor.
- Do not stand on the product, use it as a platform, or place objects on it, as this may cause scratches, dents, or deformation to the unit. Such actions may result in product damage, malfunction, or reduced performance.
- When transporting or installing heavy products, ensure personal safety by using a lift or support, or by having multiple people work on the product.
- When performing installation, adjustment, or similar work, post a warning sign to prevent the power from being turned on unexpectedly during the procedure. If the power supply is turned on unexpectedly, there is a possibility of electric shock or injury due to sudden activation.
- Do not place magnetic media or similar items within 1 m [3.280 ft] of an energized product. The magnetic field from the magnet may destroy data stored on magnetic media.
- Do not block the ventilation holes on the back of the product. Blocking them may cause equipment damage or injury.
- Always stop operation before moving the product, and be careful to prevent it from falling.
- The compressor does not contain any built-in filtration devices or pressure regulation equipment. An air filter and regulator must be installed before using it.
- Be sure to install a filter on the suction port of the vacuum pump. Failing to use a filter may allow dust or debris to enter the pump, causing malfunction, rapid performance deterioration, or reduced service life within a short period.
- These products are not completely airtight. For applications requiring pressure (including vacuum) retention, design your system to take into account the required volume and retention time.

ATTENTION

- When considering use under conditions or in environments not specified in the catalog or instruction manual, or for applications where particularly high safety is required—such as in aviation facilities, combustion equipment, amusement machines, safety devices, or other applications that could significantly impact human life or property—please ensure ample margins in ratings and performance, and take appropriate safety measures such as fail-safe mechanisms. Be sure to consult our sales representative.

- Perform wiring and piping of the product by referring to this catalog and other technical documentation as needed.
- Do not change the pressure switch settings of the product. Doing so may cause malfunction.
- When handling the product, be sure to wear protective gloves, safety glasses, safety shoes, or other necessary protective equipment to ensure safety.
- When the product is no longer usable or needed, dispose of it properly as industrial waste.
- The performance and functions of pneumatic equipment deteriorate with age. Pneumatic equipment should be inspected on a daily basis to confirm that all requisite system functions are satisfied, to prevent accidents from happening.
- Ambient temperature should be 0 to 40°C [32 to 104°F]. When installing the product in a system, pay particular attention to the ambient temperature range of 0 to 40°C [32 to 104°F].
- Do not remove the rubber feet during use. Doing so may increase noise, cause the product to move due to vibration, or result in internal failure or abnormal operation.
- For inquiries regarding the product, contact the Technical Service Center. The address and phone number are listed at the end of the Instruction Manual.

Other

- Be sure to observe the following guidelines.
 1. When using this product in a pneumatic system, use only genuine Koganei parts or compatible parts (recommended parts). Also, when doing maintenance and repairs, always use genuine Koganei parts or compatible parts (recommended parts). Be sure to follow the prescribed procedures and methods.
 2. Never attempt inappropriate disassembly or assembly of the product relating to its basic configuration, or its performance or functions.

Note that if the general safety precautions are not observed, our company cannot assume any responsibility.

Warranty and General Disclaimer

1. Warranty Period

The warranty period for Koganei products is 1 year from the date of delivery.

* However, some products have a 2-year warranty; contact your nearest Koganei sales office or the Koganei overseas department for details.

2. Scope of Warranty and General Disclaimer

- (1) When a product purchased from Koganei or from an authorized Koganei distributor or agent malfunctions during the warranty period in a way that is attributable to Koganei's responsibility, Koganei will repair or replace the product free of charge. Even if a product is still within the warranty period, its durability is determined by its operation cycles and other factors. Contact your nearest Koganei sales office or the Koganei overseas department for details.
- (2) The Koganei product warranty covers individual products. Therefore, Koganei is not responsible for incidental losses (repair of this product, various expenses required for replacement, etc.) caused by breakdown, loss of function, or loss of performance of Koganei products.
- (3) Koganei is not responsible for any losses or for any damages to other machinery caused by breakdown, loss of function, or loss of performance of Koganei products.
- (4) Koganei is not responsible for any losses due to use or storage of the product in a way that is outside of the product specifications prescribed in Koganei catalogs and instruction manuals, and/or due to actions that violate the mounting, installation, adjustment, maintenance or other safety precautions.
- (5) Koganei is not responsible for any losses caused by breakdown of the product due to factors outside the responsibility of Koganei, including but not limited to fire, natural disaster, the actions of third parties, and intentional actions or errors by the purchaser.

2. Models

● Compressor/Vacuum Pump

DP [] - [] [] - []

- Assembly options
Blank : Without
P : Sealing plug for discharge/suction port
 - Device input power
D4 : Without AC adapter
AD : With AC adapter
 - Installation type
AY : Horizontal
AT : Vertical
 - P** : Compressor
V : Vacuum pump
- Additional parts
AC adapter (with power cable)
Model to order: **AD-DPA**



● Air Tank

DPT - [] 18 - [] - []

- Assembly options
Blank : Without
P : With sealing plug
 - Drain port
P : With sealing plug
V : With hand valve
 - Installation type
Y : Horizontal
T : Vertical
- Hand valve
Model to order: **FVU6-6-2**

3. Names of Parts

● Compressor/Vacuum Pump

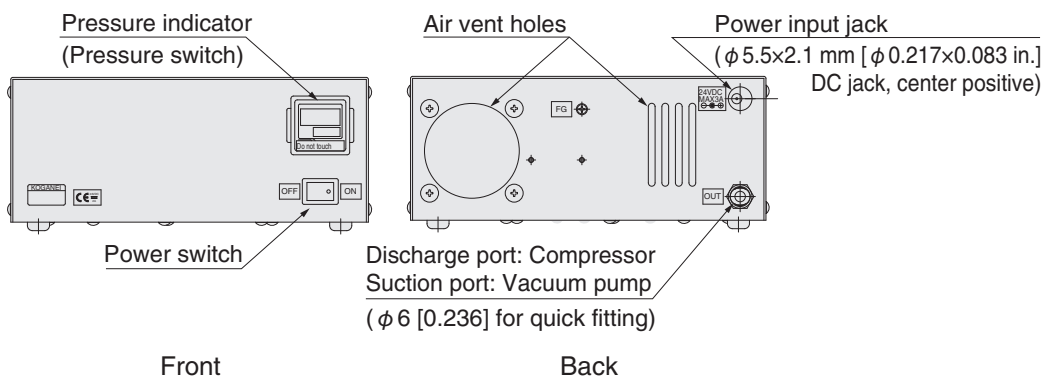

● Air Tank

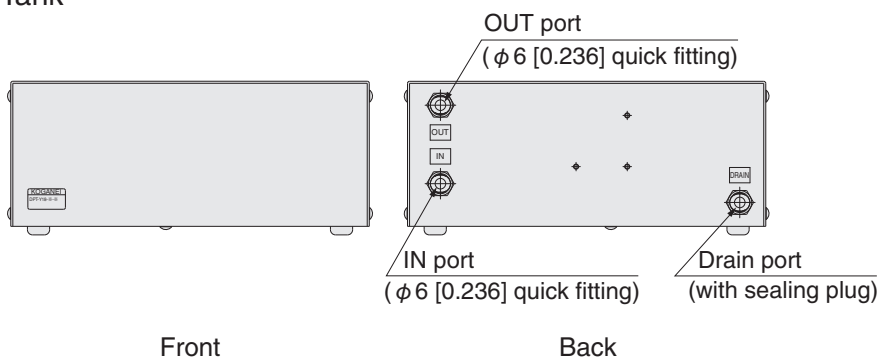

4. Installation

1. The product should be placed on a firm, level, flat surface to prevent rattling.
2. Allow sufficient space for installation.
3. Avoid using the unit if it is exposed to water or oil droplets, or in locations that are very dusty.
4. The side of the compressor or vacuum pump that has the air vents must be at least 40 mm [1.575 in.] away from the wall to ensure the ventilation holes are not blocked. If sufficient space for ventilation is not provided, proper air circulation will not be possible and internal temperatures will rise, resulting in a significant decrease in service life.

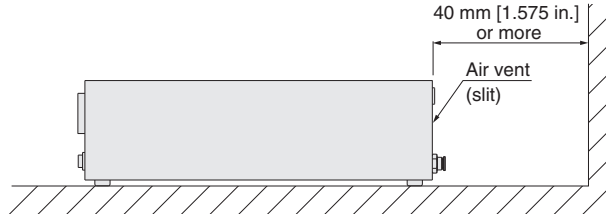

5. Avoid using the equipment in locations where corrosive gases, such as sulfuric acid or hydrochloric acid, or ozone, are present.
6. Do not use the equipment in locations where it will be exposed to strong vibrations or shocks.
7. The compressor does not contain any built-in filtration devices or pressure regulation equipment. An air filter and regulator must be installed before using it.

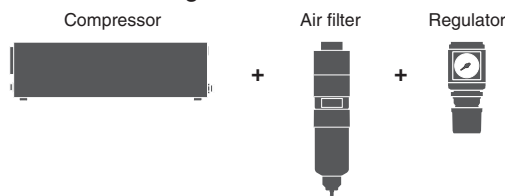

8. Be sure to install a filter on the suction port of the vacuum pump. Failing to use a filter may allow dust or debris to enter the pump, causing malfunction, rapid performance deterioration, or reduced service life within a short period.
9. Be sure to install a residual pressure exhaust mechanism on the OUT side of the compressor or vacuum pump.

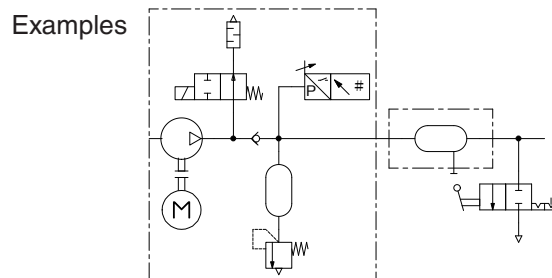

5. Wiring

1. If you are not using the optional AC adapter, connect a 24 V DC, 2 A power source to the power input jack ($\phi 5.5 \times 2.1$ mm [$\phi 0.217 \times 0.083$ in.] DC jack, center-positive, compliant with the former EIAJ standard RC-6705).
2. If equipped with an AC adapter, connect the input plug to the power input jack first, then plug it into a 100 V AC power source.
3. When connecting the power cord, be sure to insert the jack and plug all the way in. A loose connection may cause electric shock or a short circuit.
4. The AC adapter (**AD-DPA**) is equipped with an overcurrent protection circuit that cuts off the power supply if the current exceeds 2.7A. If the unit does not operate even after turning on the power switch, check the outlet on the primary side of the AC adapter. If the unit still does not operate after turning the switch on again, inspection or repair is required. Contact your nearest sales office or technical service center. The address and phone number are listed at the end of the Instruction Manual.
5. If you are not using the optional AC adapter, install a 3A overcurrent protection circuit in the power supply circuit.
6. To protect the equipment installed with this product, be sure to ground the frame ground (F.G.) terminal.

6. Piping

1. The piping ports on the compressor, vacuum pump, and air tank are equipped with quick connectors for tubes with an outer diameter of 6 mm [0.236 in.].
2. Do not bend or kink the tubing excessively near the fittings. Doing so can cause air leaks. The approximate minimum bending radius of nylon tubes and urethane tubes is shown in the table below.



1. Use tubing with no scratches on the outer surface. If scratches develop from repeated use, cut off the affected section.
2. Do not bend or kink the tubing excessively near the fittings. Doing so can cause air leaks. The approximate minimum bending radius of nylon tubes and urethane tubes is shown in the table below.
3. Do not use extremely soft tubing, as it significantly reduces the pull-out strength.
4. Be sure to shut off the air supply before attaching or removing the tubing. Also, make sure all air has been completely purged from the piping before proceeding.

Tube size	Minimum bending radius	
	Nylon tube	Urethane tube
φ6 [0.236]	30 [1.181]	15 [0.591]

3. Attaching and Removing Tubes



Always turn off the power switch and use the residual pressure exhaust mechanism to release any remaining air before attaching or detaching the tube.

Precautions for Attaching Tubes

- ① Make sure that the cut end of the tube is perpendicular, that there are no scratches on the outer surface, and that the tube is not oval.
- ② When attaching a tube, be sure to insert it all the way to the end, otherwise it may cause leaks.

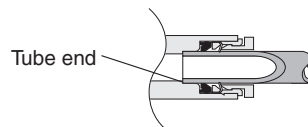

- ③ After attaching a tube, pull on it to ensure it does not come out.

Precautions for Removing Tubes

- ① Before removing a tube, make sure that the pressure inside the compressor is at zero.
- ② Press the release ring evenly all the way in, then pull the tube out toward you. If the ring is not pushed in far enough, the tube may not come out, or it may become damaged, leaving debris inside the fitting.

How to Attach and Remove Tubes

① Attaching Tubes

With the quick connector, simply insert the tube all the way to the tube end. The locking claws will secure the tube, and the elastic sleeve will seal the outer circumference of the tube.

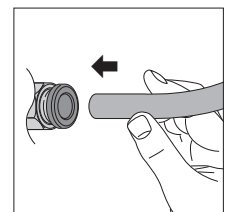

② Removing Tubes

To remove a tube, press the release ring to open the locking claws, allowing the tube to be pulled out.

Be sure to turn off the air supply before removal.

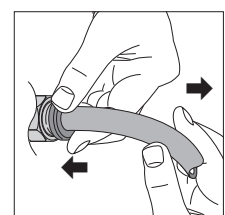

7. Operation

1. Before operation, verify that all piping and wiring have been properly installed.
2. For compressors, when the power switch is turned ON, the pressure switch lights and the pressure reading rises. The compressor automatically stops (unloads) when the internal pressure reaches 0.60 MPa [87 psi]. As compressed air is consumed and the internal pressure in the compressor drops to 0.55 MPa [80 psi], the compressor automatically restarts (loads).



If the compressed air consumption exceeds the compressor's capacity, it will operate continuously.

3. For vacuum pumps, when the power switch is turned ON, the pressure switch lights and the pressure reading falls. The vacuum pump automatically stops (unloads) when the internal pressure reaches -50 kPa [-14.770 inHg]. As air is drawn in, the pressure inside the vacuum pump rises, and when it reaches -30 kPa [-8.862 inHg], it automatically restarts (loads).



If the air intake exceeds the vacuum pump's capacity, it will operate continuously.

4. Turning the power switch to the OFF position will stop the unit.



Be careful, because even after stopping operation, residual pressure remains in the internal tank, piping, and other components of the compressor and vacuum pump.

5. Additionally, if you temporarily require large amounts of compressed air or vacuum, installing an air tank **DPT** is recommended.
6. Do not change the pressure switch settings. Doing so may shorten the service life of the equipment.
7. Compressors always produce condensate (moisture). This is not a malfunction. Be sure to install an air filter with a drain mechanism on the secondary side and drain the condensate regularly.

8. Draining Condensate

You can drain the condensate from the air tank by removing the sealing plug from the drain port. Before removing the sealing plug, always release the pressure inside the tank and make sure that the internal pressure has returned to atmospheric pressure before proceeding. Be sure to replace the plug after draining the condensate.

-V: Drain port with hand valve

Air tanks equipped with a hand valve allow you to drain the condensate simply by turning the handle. When using the tank, always ensure the valve is closed, as shown in the figure below. To drain the condensate, be sure to release the pressure inside the tank and make sure that the internal pressure has returned to atmospheric pressure opening the hand valve. To open the valve, turn the top knob clockwise 90°. After draining the condensate, be sure to return the knob to its original closed position.

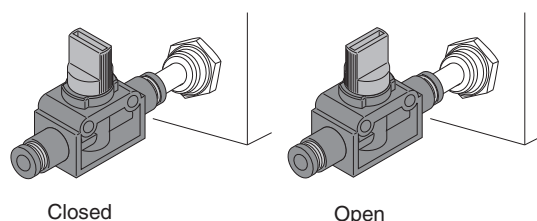

9. Specifications

Compressor

Item	Model	
	DPP-AY□□	DPP-AT□□
Installation orientation	Horizontal installation	Vertical installation
Input voltage	DC24V (Switching power supply can be used)	
Rated current	2A	
Input plug	φ5.5×2.1 mm [φ0.217×0.083 in.] DC jack compatible (center positive)	
Discharge flow rate	2.3 L/min [0.081 ft ³ /min] (at 0.5 MPa [73 psi])	
Ambient temperature range	0 to 40 °C [32 to 104 °F] (no freezing or condensation allowed)	
Maximum pressure	0.60 MPa [87 psi]	
Control pressure OFF/ON	0.60 [87]/0.55 MPa [80 psi] (unload/load)	
Internal tank capacity	900mL	
Noise level	55dB	
Piping ports	Quick fitting for 6 mm [0.236 in.] outer diameter tubing	
Mass	4.6 kg [10.143 lb]	

Air Tank

Item	Model	
	DPT-Y18	DPT-T18
Installation orientation	Horizontal installation	Vertical installation
Operating fluid	Air	
Maximum operating pressure	0.8 MPa [116 psi]	
Ambient temperature range	0 to 40 °C [32 to 104 °F] (no freezing allowed)	
Internal tank capacity	1800mL	
Piping ports	Quick fitting for 6 mm [0.236 in.] outer diameter tubing	
Mass	3.2 kg [7.056 lb]	

Vacuum Pump

Item	Model	
	DPV-AY□□	DPV-AT□□
Installation orientation	Horizontal installation	Vertical installation
Input voltage	DC24V (Switching power supply can be used)	
Rated current	2A	
Input plug	φ5.5×2.1 mm [φ0.217×0.083 in.] DC jack compatible (center positive)	
Suction rate	6.0 L/min (ANR) [0.212 ft ³ /min (SCFM)]	
Ambient temperature range	0 to 40 °C [32 to 104 °F] (no freezing or condensation allowed)	
Maximum vacuum	-75 kPa [-22.155 inHg]	
Control pressure OFF/ON	-50 [-14.770]/-30 kPa [8.862 inHg] (unload/load)	
Internal tank capacity	900mL	
Noise level	55dB	
Piping ports	Quick fitting for 6 mm [0.236 in.] outer diameter tubing	
Mass	4.5 kg [9.923 lb]	

AC adapter (with power cable)

Item	Model	
	AD (AD-DPA)	
Input voltage	AC100 to 240V	
Output voltage	DC24V	
Rated current	2.5A	
Mass	0.43 kg [0.948 lb]	

Note: The included power cable is rated for 100 V AC. Connect it to a 100 V AC outlet to use the device.

10. Performance Graphs

Compressor

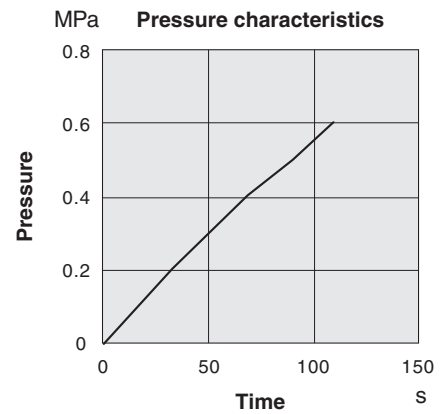
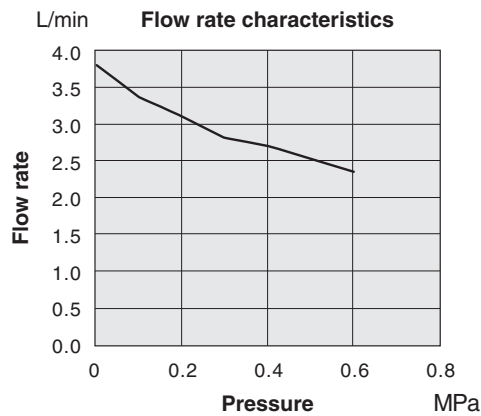

Vacuum Pump

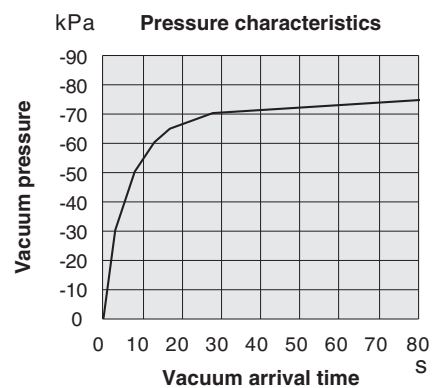
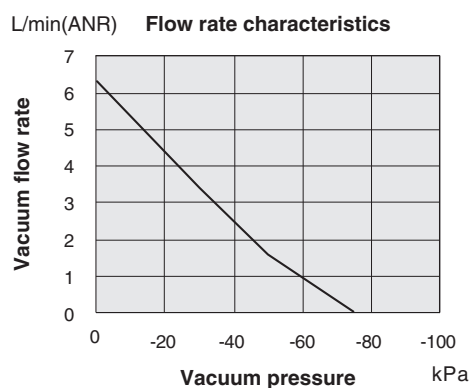

* Based on our initial performance tests

11. Dimensions (mm [in.])

Compressor
DPP-AYD4 (-P)
DPP-AYAD (-P)
 Vacuum Pump
DPV-AYD4 (-P)
DPV-AYAD (-P)
 (Horizontal installation)

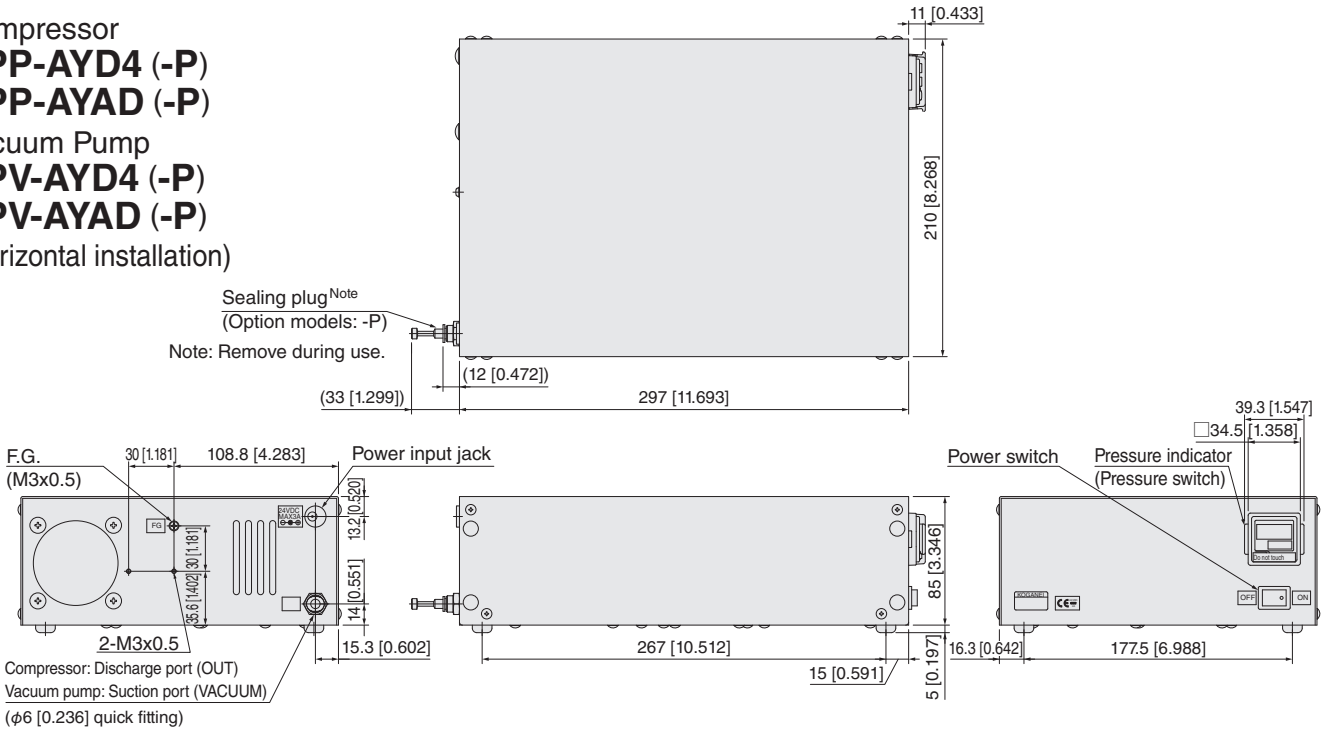

Compressor
DPP-ATD4 (-P)
DPP-ATAD (-P)
 Vacuum Pump
DPV-ATD4 (-P)
DPV-ATAD (-P)
 (Vertical installation)

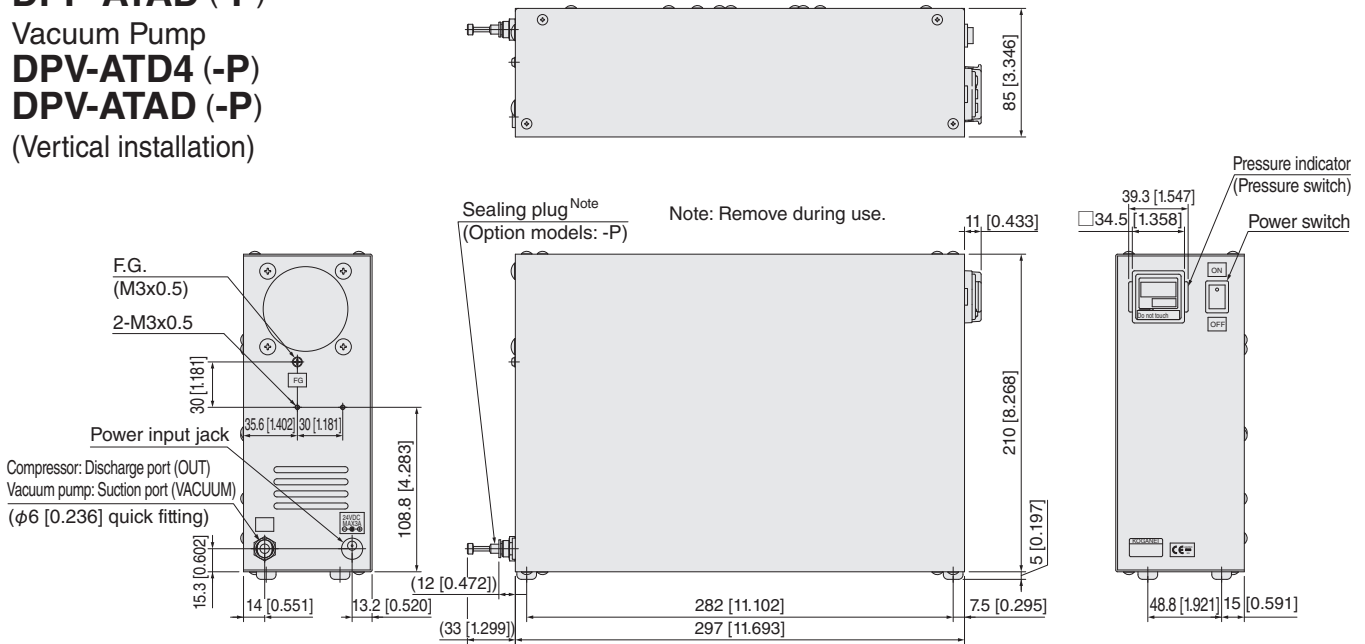

Compressor/Vacuum Pump Option
AD (AC adapter AD-DPA)

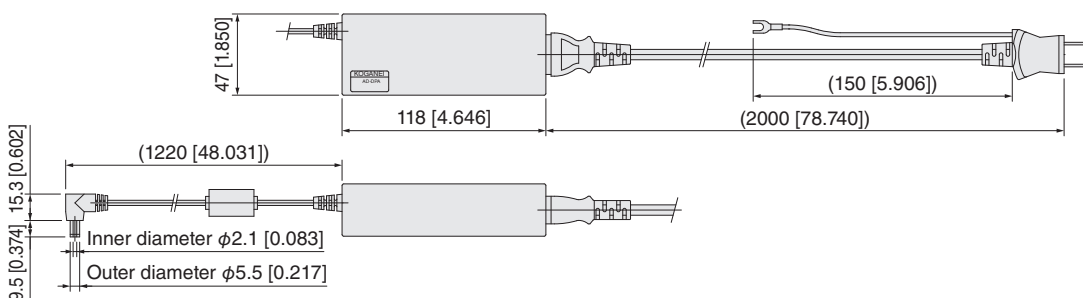

Air Tank
DPT-Y18-P (-P)
 (Horizontal installation)

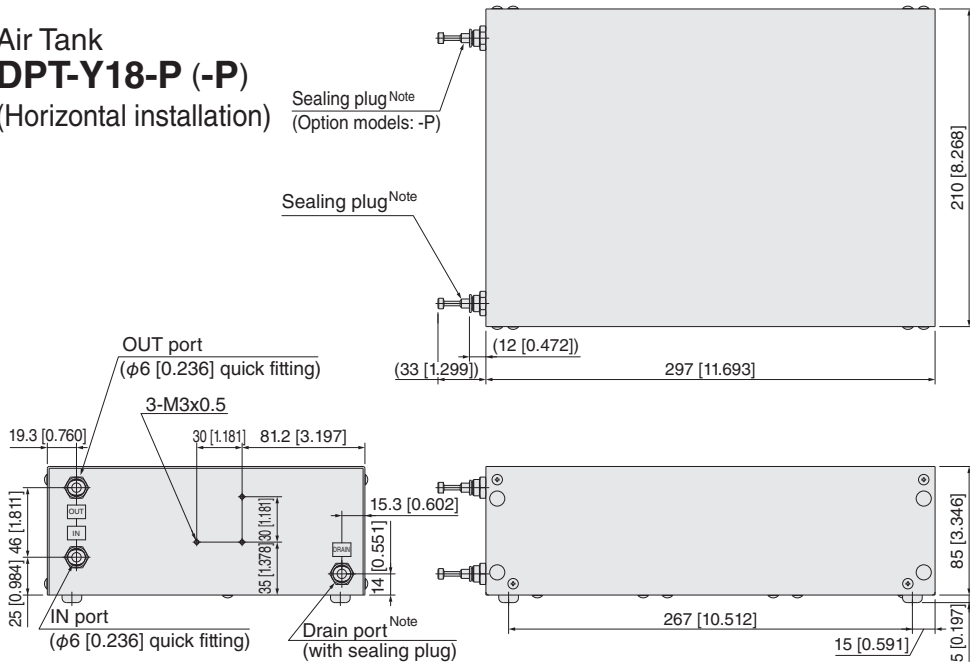

Note: Remove the sealing plug from the OUT port during use.
 Do not remove the sealing plug from the drain port except when draining condensate.

Air Tank
DPT-T18-P (-P)
 (Vertical installation)

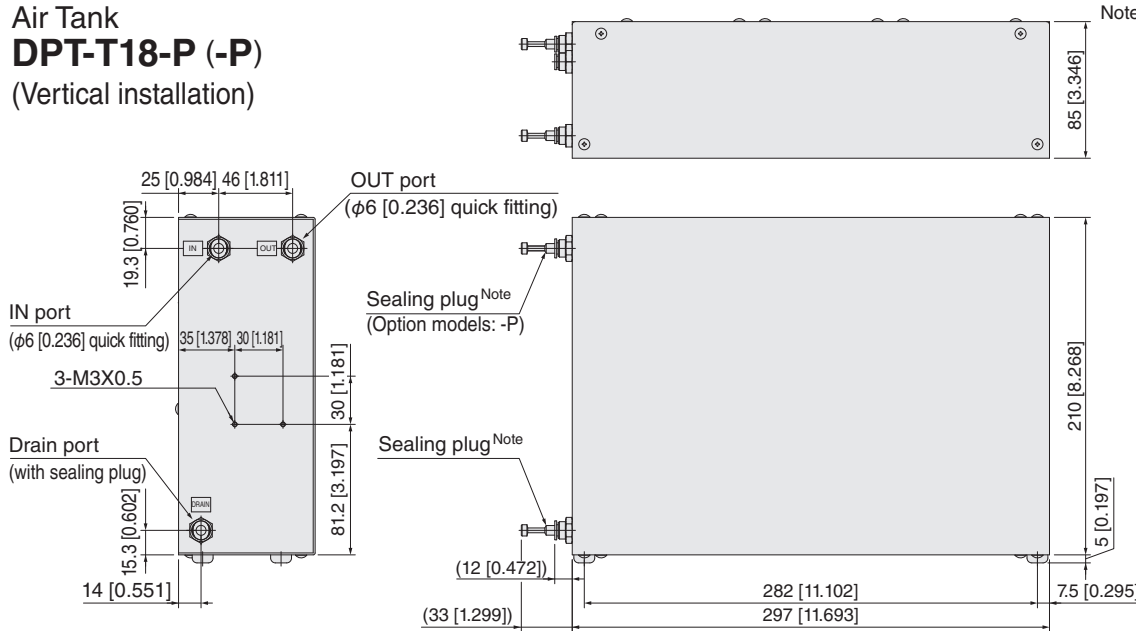

Note: Remove the sealing plug from the OUT port during use.
 Do not remove the sealing plug from the drain port except when draining condensate.

Air Tank Option
DPT-Y18-V

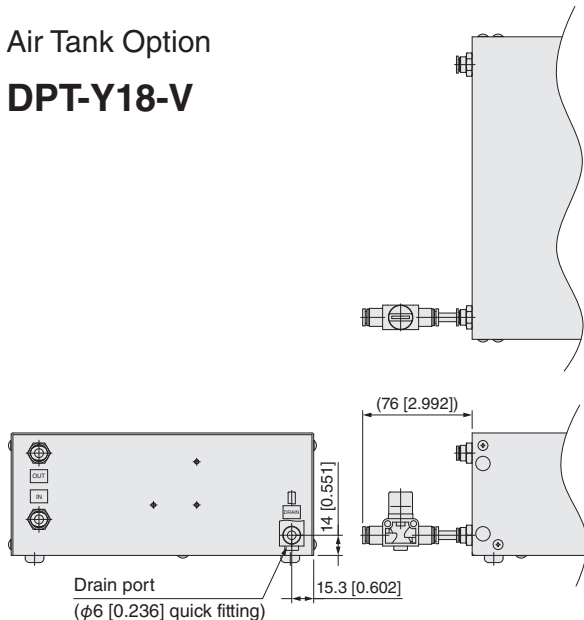

DPT-T18-V

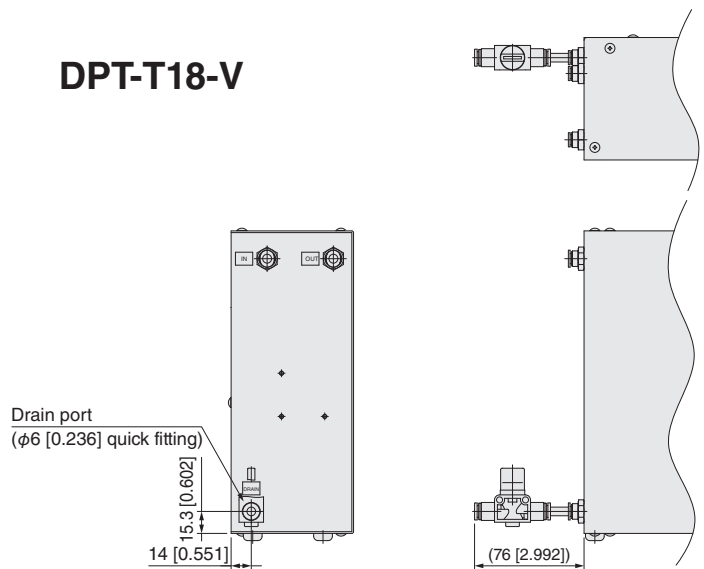

12. Warranty and Repairs

1 Warranty Period and Coverage

- (1) The warranty period is one year from the date of delivery or until 4,000 operating hours have been reached, whichever comes first.
- (2) If, during the warranty period, a failure or damage occurs due to defects in our design or manufacturing despite normal use, we will repair the product free of charge.
- (3) Repairs for malfunctions and damage caused by the following reasons will be subject to a charge.
 - Malfunctions or damage occurring after the warranty period has expired
 - Malfunctions or damage resulting from improper use or storage
 - Malfunctions or damage resulting from the use of parts other than those specified by us
 - Malfunctions or damage resulting from repairs or modifications performed by parties other than us or our authorized representatives
 - Malfunctions or damage resulting from natural disasters or force majeure
- (4) The cause of any failure or damage will be determined by us; however, if a determination is difficult, it will be decided through consultation between the customer and us.
- (5) Please note that we cannot compensate for any secondary damages or expenses resulting from product malfunction or damage.

2 Repairs

- (1) If any abnormality occurs in this product, stop operation and check whether it is a malfunction.
- (2) For repair requests, please contact your dealer or us directly.
- (3) When requesting repairs, please provide the following information:
 - ① Model name and serial number (indicated on the label)
 - ② Period of use and operating conditions
 - ③ Location of the malfunction and details of the problem

If you have any problems with the content of this publication or technical questions,
please contact the Koganei Overseas Group below.



KOGANEI CORPORATION

Overseas Group

TEL: (+81)-3-6721-7478

Desktop Type
**Compressor
Vacuum Pump
Air Tank**

Instruction Manual

April 2026 Y143266 Ver.1.0

The contents of this manual, or any portion thereof, may not be
duplicated or copied without permission by Koganei.