

AIR HANDS SERIES

Full Line-up



Page 1399

Parallel Type Linear Guide Specification NHC1 Series

- **40% lighter:** Now about 40% lighter than the previous NHB series linear guide specification.
- **45% more compact:** Reduced the width, length, and height.
- **Strong:** Use of high-rigidity linear guide achieves repeatability of $\pm 0.01\text{mm}$ [$\pm 0.0004\text{in.}$] or less. Centering accuracy is also $\pm 0.07\text{mm}$ [$\pm 0.0028\text{in.}$] or less.



Page 1403

Parallel Type Linear Guide Specification

- Lever portion uses a linear guide for long operating life, high precision, long lever travel gripping, and overhang gripping.
- Gripping position repeatability $\pm 0.01\text{mm}$ [$\pm 0.0004\text{in.}$]. Centering accuracy is also $\pm 0.07\text{mm}$ [$\pm 0.0028\text{in.}$].
- Magnet for sensor switch is standard equipment.



Page 1407

Parallel Type Linear Guide Specification Long Stroke

- Open/closed stroke is about double the previous model.
- Gripping position repeatability is $\pm 0.01\text{mm}$ [$\pm 0.0004\text{in.}$].



Page 1411

Parallel Type Linear Guide Specification with Fingers

- Fingers attachment is simple to install.
- Gripping position repeatability is $\pm 0.01\text{mm}$ [$\pm 0.0004\text{in.}$].

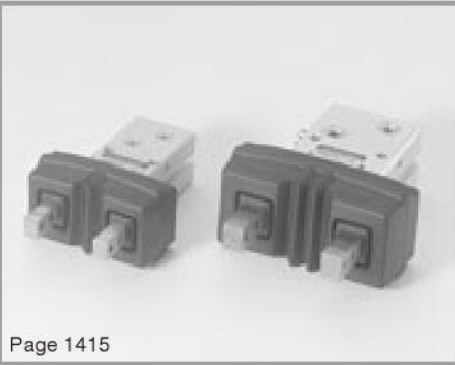

Page 1415

Parallel Type Linear Guide Specification with Rubber Cover

- Dust protection cover is standard equipment.
- Lever portion uses a linear guide for long operating life, high precision, long lever travel gripping, and overhang gripping.
- Gripping position repeatability ± 0.01 mm [± 0.0004 in.].
- Magnet for sensor switch is standard equipment.



Page 1419

Parallel Type Linear Guide Specification for Clean Systems

- Clean rating corresponds to Class 4 (during suction).
- Gripping position repeatability is ± 0.01 mm [± 0.0004 in.].



Page 1423

Three-finger Type Linear Guide Specification

- Linear guides are used on three-finger hand! Superior load and moment resistance.
Centering accuracy is ± 0.05 mm [± 0.0020 in.] or less.
Gripping position repeatability is ± 0.01 mm [± 0.0004 in.] or less.
- Body is equipped with a hollow space. Convenient for installing a cylinder for workpiece release, etc.



Page 1426

Parallel Type Cross Roller Bearing Specification

- Lever portion uses cross roller bearings for long operating life and high precision.
- Gripping position repeatability ± 0.01 mm [± 0.0004 in.].
- Dust protection cover is optional.
- Magnet for sensor switch is standard equipment.



Page 1430

Parallel Type Plain Bearing Specification

- Lever portion uses a slide plate for long operating life.
- Magnet for sensor switch is standard equipment.
- 3-way direct mounting.



Page 1434

Swing Type

- Lever uses chrome molybdenum steel, with quench hardened major parts, to achieve long operating life.
- Magnet for sensor switch is standard equipment.
- 3-way direct mounting.



Page 1439

Swing Type High Precision, 180° Open Specification

- Uses a thrust bearing in the lever support area to achieve high precision, high rigidity, and long operating life.
- Uses a link mechanism for compact, high gripping force. Open-close up to 180°.



Page 1443

Swing Type 180° Open Specification

- Lever uses chrome molybdenum steel, with quench hardened major parts, to achieve long operating life.
- Open/close angle 180°, to allow gripping and releasing of workpieces without retracting a hand body.
- Magnet for sensor switch is standard equipment.
- 3-way direct mounting.

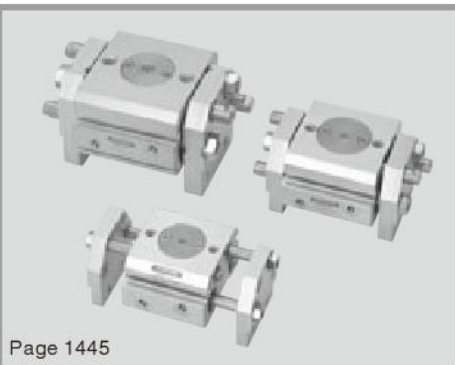

Page 1445

Rack Operation Parallel Type

- Four types of lever with open/close travel strokes, at 24, 32, 40, and 50mm [0.945, 1.260, 1.575, 1.969in.].
- Magnet for sensor switch is standard equipment.

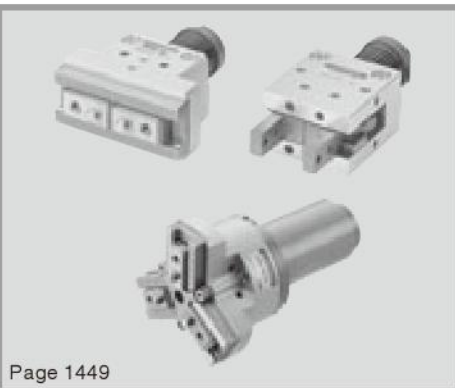

Page 1449

Mechanical Hands

- Because these do not require air piping, these are optimum for locations where air piping cannot reach (such as on index table, etc.).
- Three types available, including parallel type, parallel type linear guide specification, and linear guide specification three-finger type.
- Spring force can be set to strong or weak in response to the workpiece.
- The linear guide specification uses a linear guide on the lever, to achieve high precision ($\pm 0.01\text{mm}$ [$\pm 0.0004\text{in.}$]) and long operating life.

Handling Instructions and Precautions



General precautions

Media

1. Use air for the media. For the use of any other media, consult us.
2. Air used for the air hand (gripper) should be clean air that contains no deteriorated compressor oil, etc. Install an air filter (with filtration of a minimum 40µm) near the air hand (gripper) or valve to remove collected liquid or dust. In addition, drain the air filter periodically.

Piping

1. Always thoroughly blow off (use compressed air) the tubing before connecting it to the air hand (gripper). Entering metal chips, sealing tape, rust, etc., generated during piping work could result in air leaks or other defective operation.
2. When screwing in piping or fittings to the air hand (gripper), tighten to the appropriate tightening torque shown below.

Connecting thread	Tightening torque N·m [ft·lbf]
M3×0.5	0.6 [0.44]
M5×0.8	1.6 [1.18]

Lubrication

Cylinder portion

The product can be used without lubrication, if lubrication is required, use Turbine Oil Class 1 (ISO VG32) or equivalent. Avoid using spindle oil or machine oil.

Lever slide portion

The product can be used without lubrication, if lithium-based grease or urea-based grease is applied, it will increase the product's operating life.

Atmosphere

If using in locations subject to dripping water, dripping oil, etc., or to large amount of dust, use a cover to protect the unit. Select the rubber cover specification, if using in locations subject to large amounts of dust.



Selection

Effective gripping force

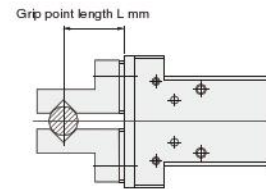

● Parallel type Linear guide specification (NHC1 series)

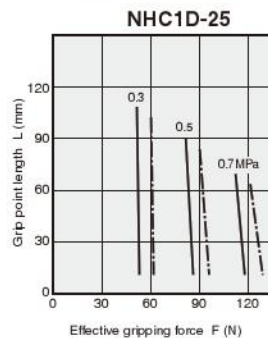
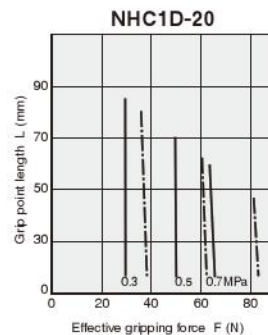
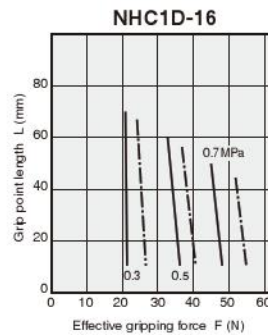
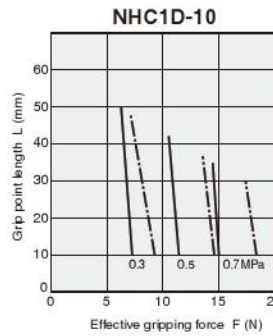

1mm = 0.0394in.
1N = 0.2248lbf.
1MPa = 145psi.

Handling Instructions and Precautions



Selection

Effective gripping force

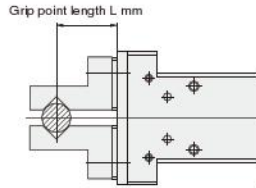

--- : Open side
— : Closed side

● **Parallel type Linear guide specification (with rubber cover)**

● **Linear guide specification Long stroke**

● **Linear guide specification for clean systems**

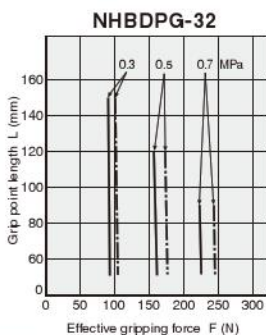
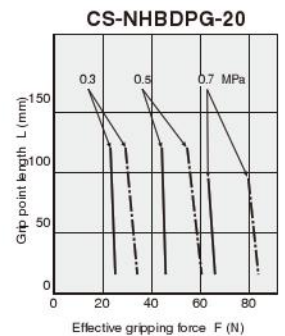
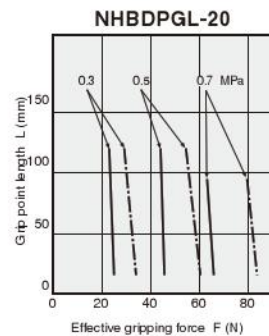
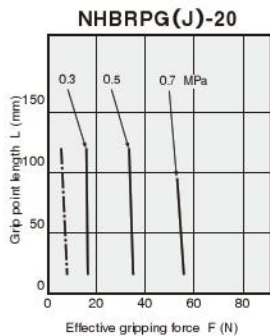
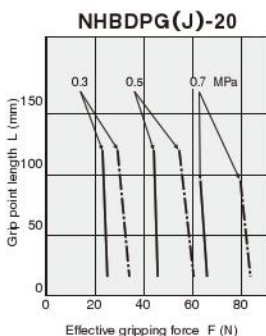
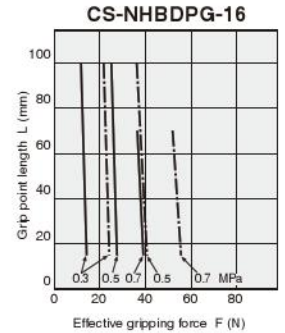
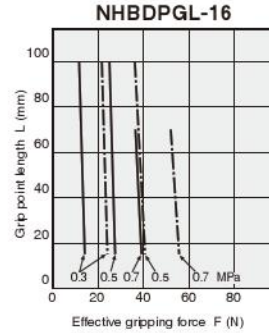
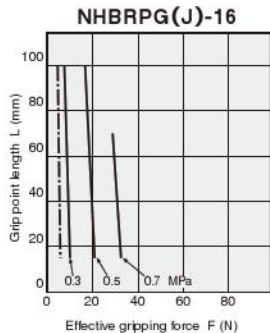
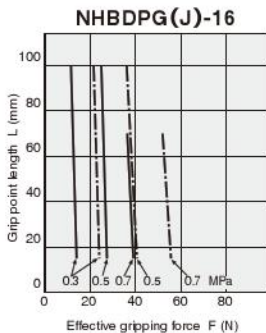
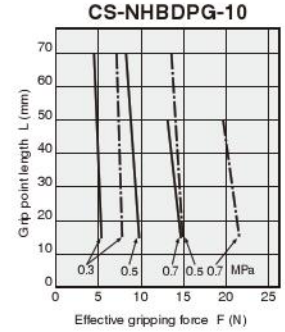
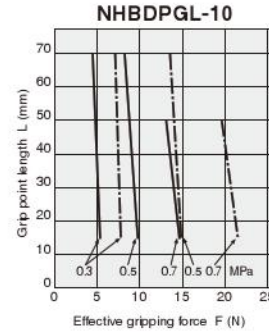
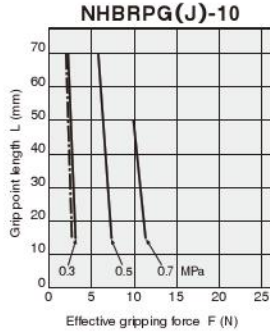
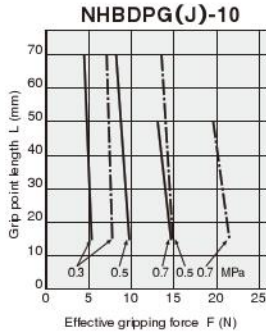
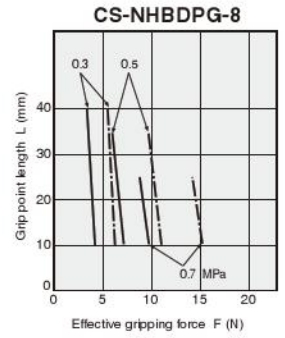
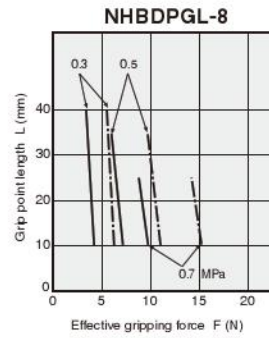
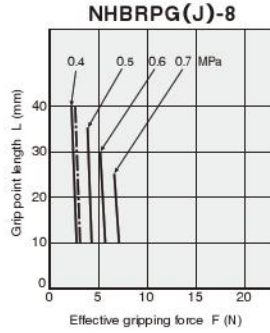
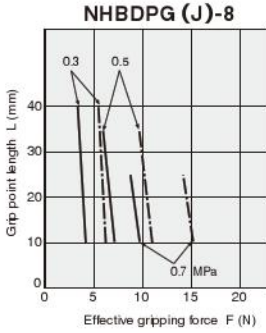

1mm = 0.0394in.
1N = 0.2248lbf.
1MPa = 145psi.

1mm = 0.0394in.
1N = 0.2248lbf.
1MPa = 145psi.

1mm = 0.0394in.
1N = 0.2248lbf.
1MPa = 145psi.

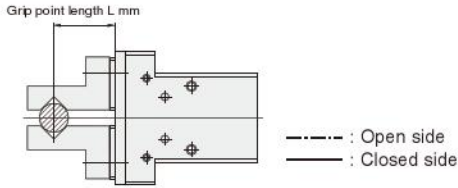

● Linear guide specification With fingers

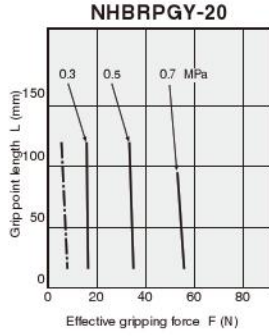
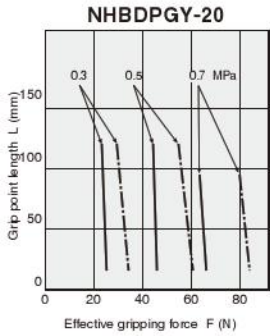
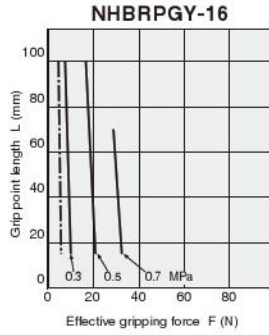
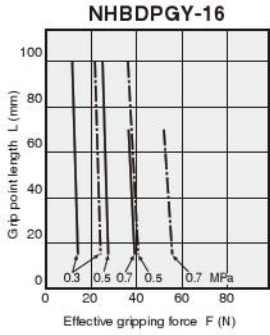
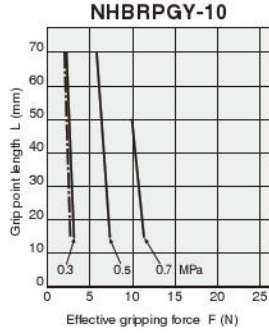
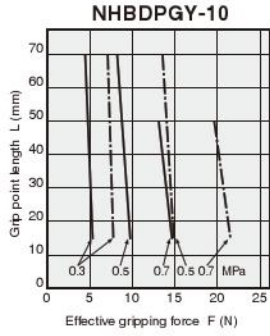
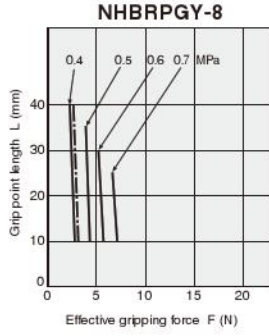
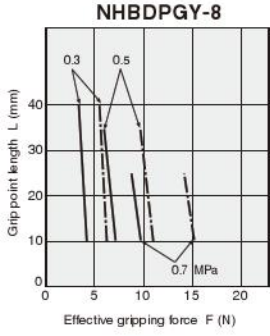

1mm = 0.0394in.
1N = 0.2248lbf.
1MPa = 145psi.

● Three-finger type Linear guide specification Air hands
(Lever open side and closed side are same value.)

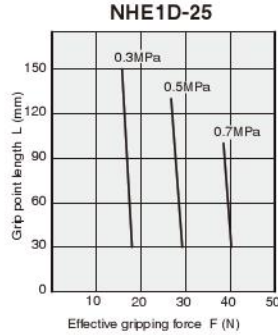
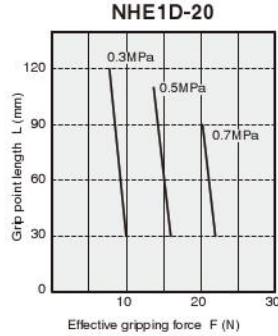
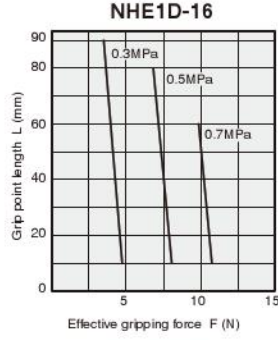

1mm = 0.0394in.
1N = 0.2248lbf.
1MPa = 145psi.

Handling Instructions and Precautions

Effective gripping force

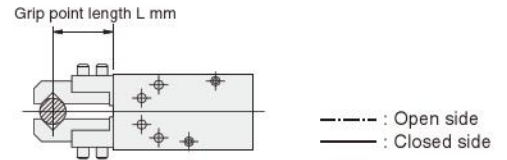
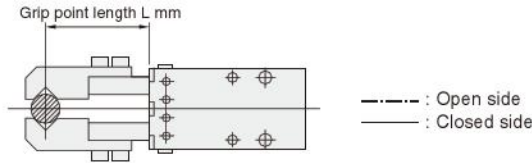

● Parallel type Cross roller bearing specification

NHBDPA-6

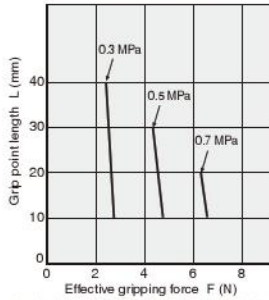

NHBRPA-6

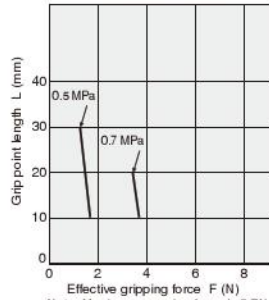

Note: Opening force is equal to or greater than closing force.

Note: Maximum opening force is 2.7N.

NHBDPA-10

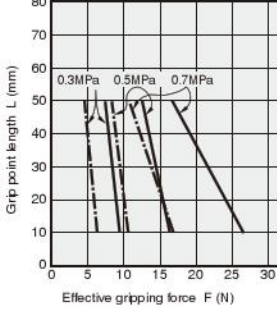

NHBRPA-10

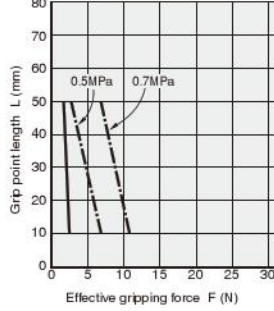

NHBDPA-16

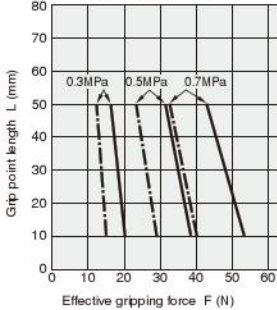

NHBRPA-16

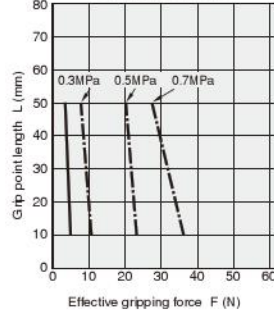

NHBDPA-20

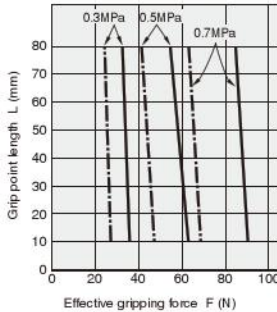

NHBRPA-20

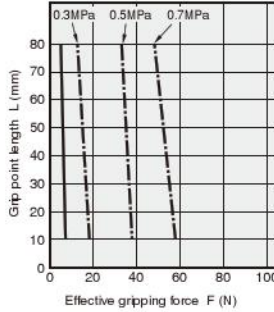

NHBDPA-25

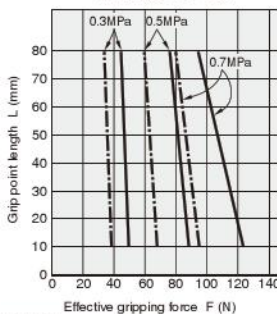

NHBRPA-25

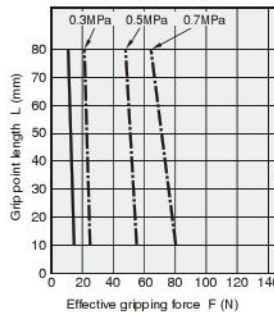

● Parallel type Plain bearing specification

NHBDP-10

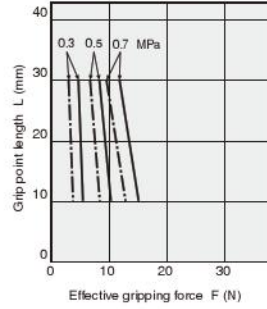

NHBRP-10

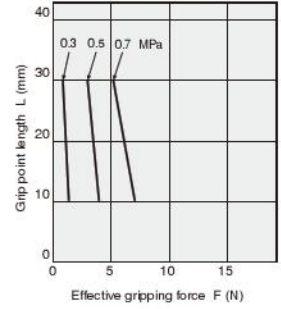

NHBDP-16

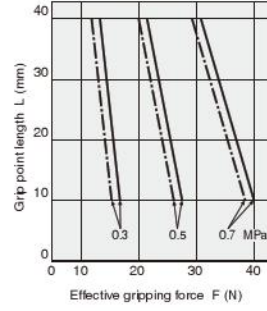

NHBRP-16

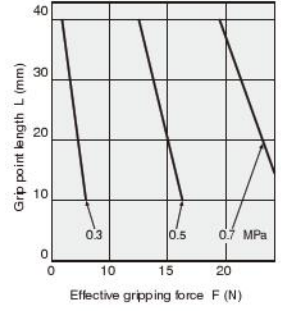

NHBDP-20

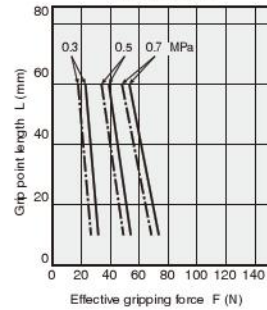

NHBRP-20

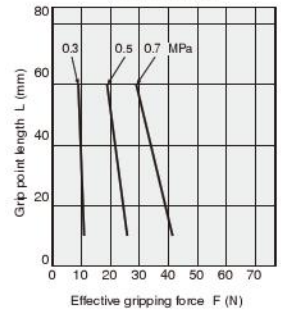

NHBDP-25

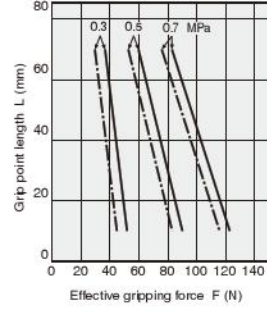

NHBRP-25

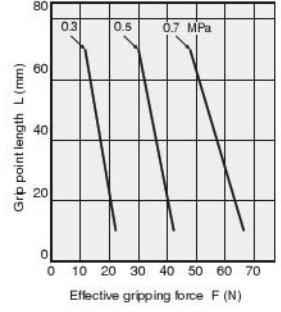

1mm = 0.0394in.
1N = 0.2248lbf.
1MPa = 145psi.

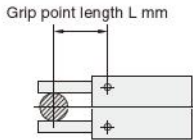

--- : Open side
 — : Closed side

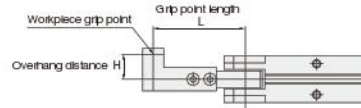

● **Swing type**

● **Swing type**
 High precision, 180° open specification

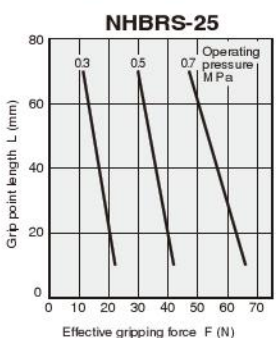
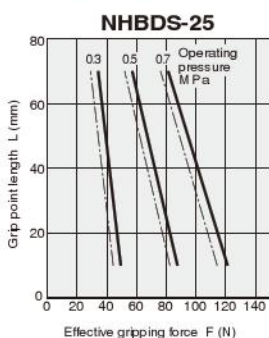
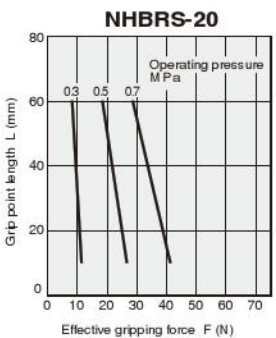
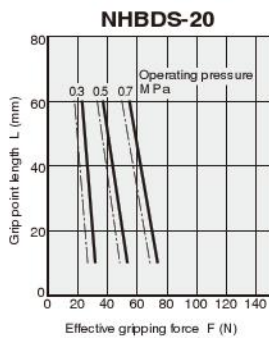
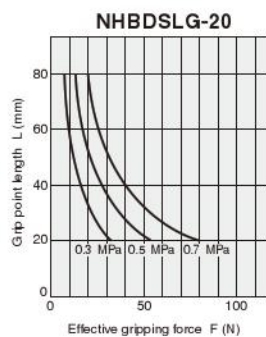
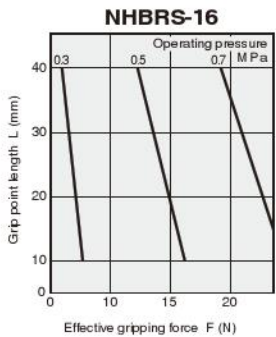
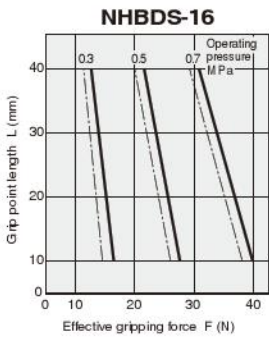
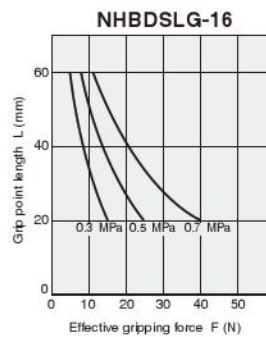
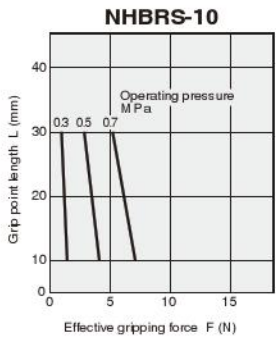
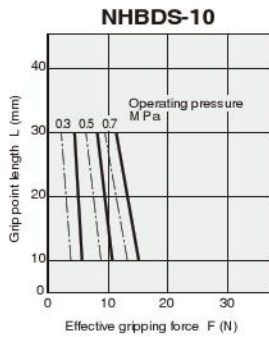
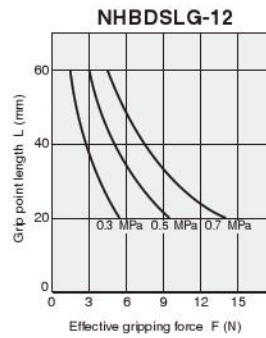
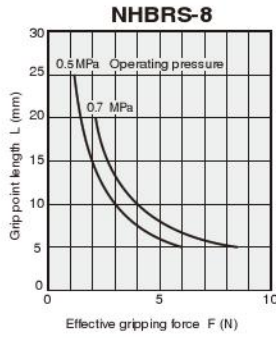
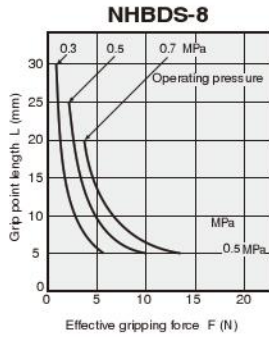

Note: Graphs show the force of closing direction.

1mm = 0.0394in.
 1N = 0.22481bf.
 1MPa = 145psi.

Handling Instructions and Precautions

Effective gripping force

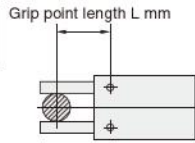

--- : Open side
 — : Closed side

Caution: For the grip point length specifications, see p.1387 for parallel type plain bearing specification and p.1385 for parallel type linear guide specification.

● Swing type 180° open specification

NHBDSL-12

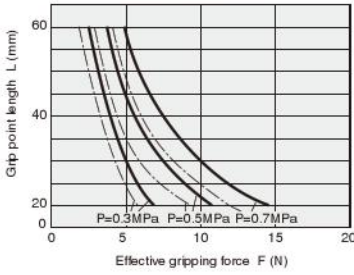

NHBDSL-16

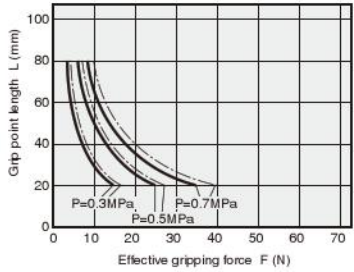

NHBDSL-20

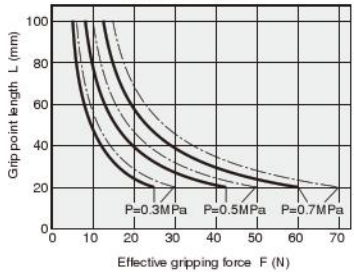

NHBDSL-25

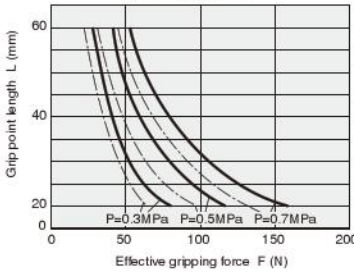

1mm = 0.0394in.
 1N = 0.2248lbf.
 1MPa = 145psi.

● Parallel type Mechanical hands

NHBMRP-10·NHBMP-10

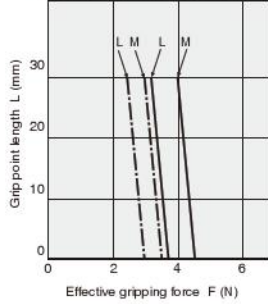

NHBMRP16·NHBMP16

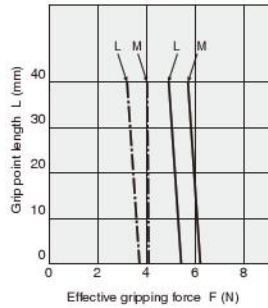

NHBMRP-20·NHBMP-20

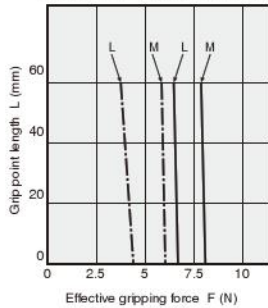

1mm = 0.0394in.
 1N = 0.2248lbf.

● Parallel type Linear guide specification Mechanical hands

NHBMPG-8

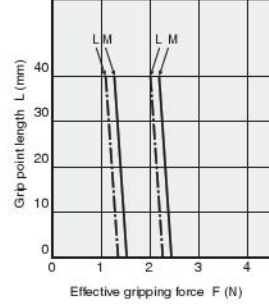

NHBMPG-10

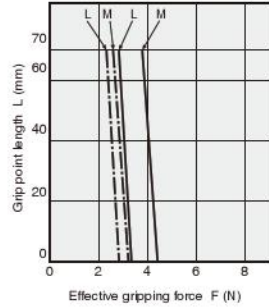

NHBMPG-16

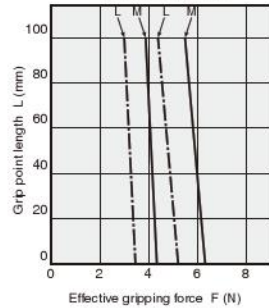

NHBMPG-20

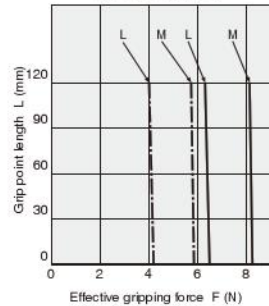

1mm = 0.0394in.
 1N = 0.2248lbf.

● Three-finger type Linear guide specification Mechanical hands

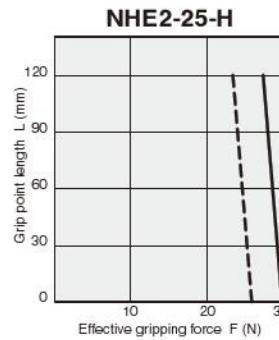
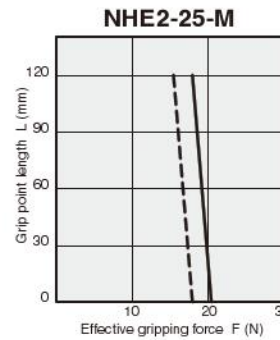
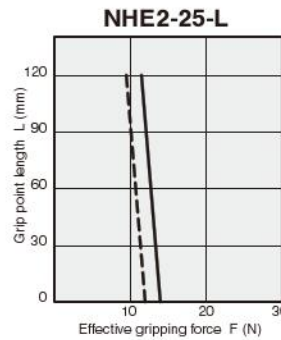
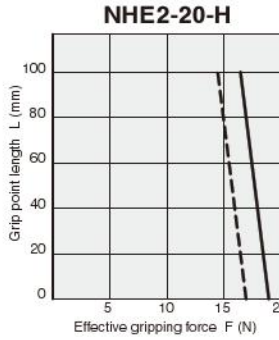
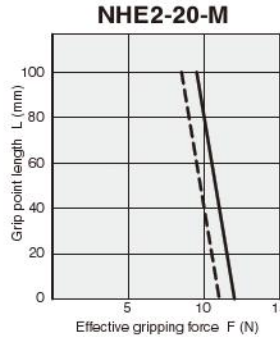
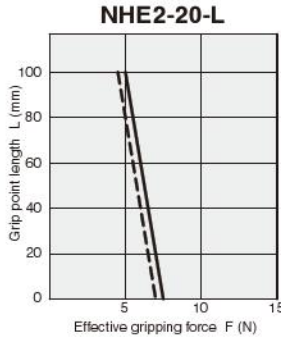
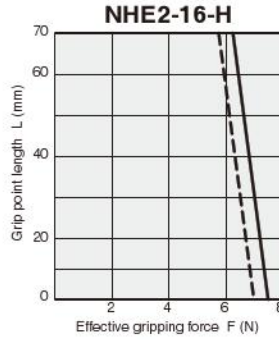
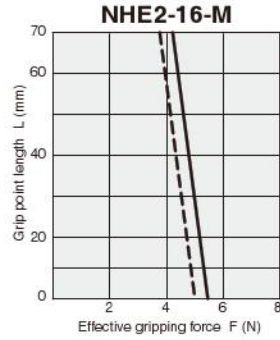
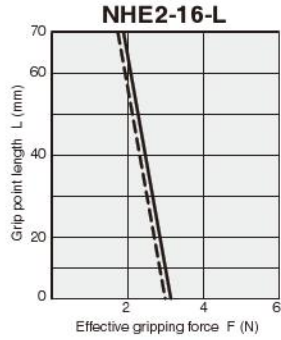

— When lever fully open
 - - - When lever fully closed

1mm = 0.0394in.
 1N = 0.2248lbf.

Effective gripping force

● WHDP series Rack operation parallel type

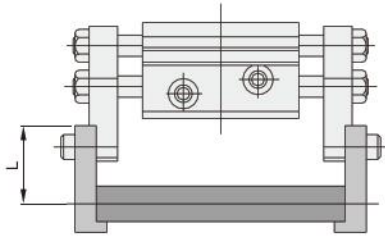

L = Grip point length

Note: Gripping force is the same for both the open and closed sides.

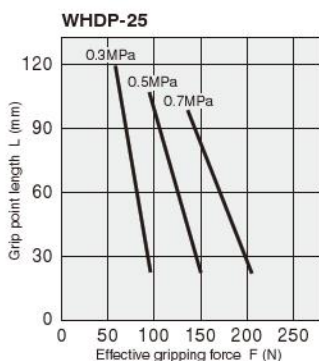
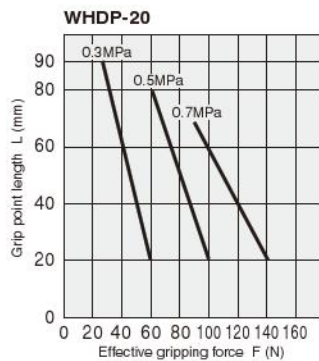
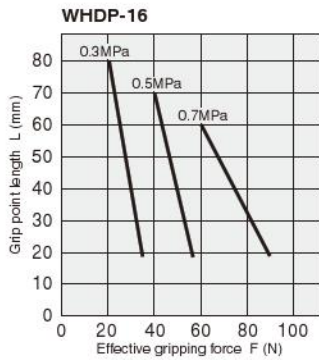
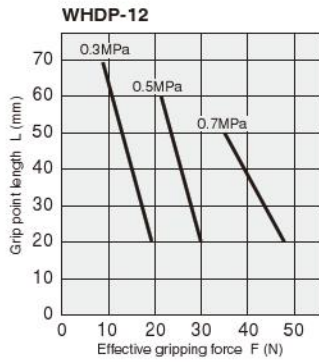

Grip point limit range

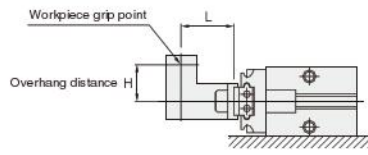

● Parallel type Linear guide specification (NHC1 series)

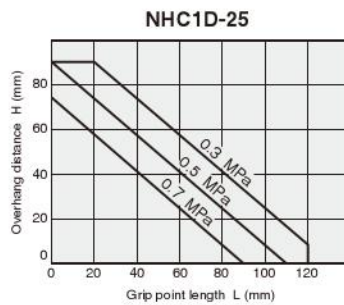
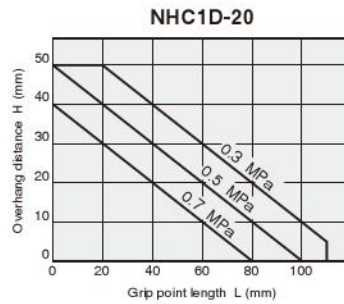
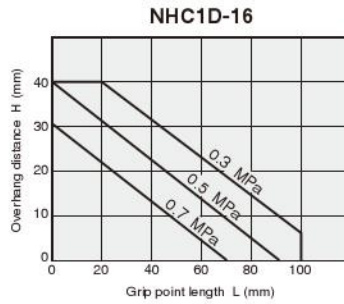
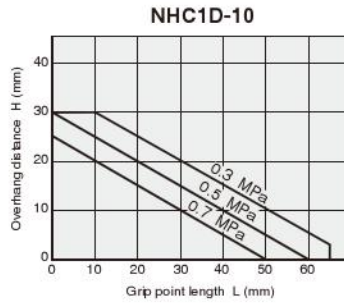

● Swing type High precision, 180° open specification

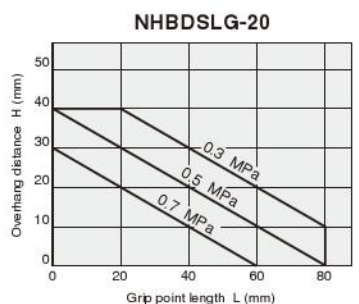
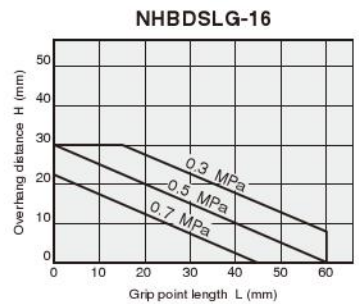
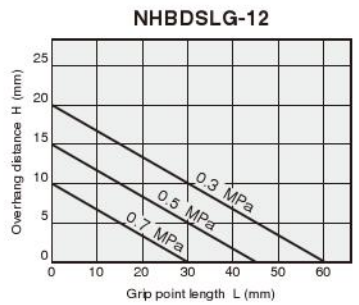

1mm = 0.0394in.
1MPa = 145psi.

1mm = 0.0394in.
1N = 0.2248lbf.
1MPa = 145psi.

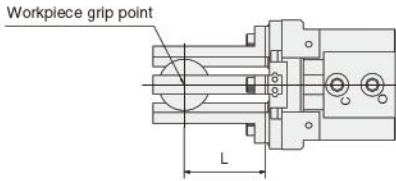

● **Three-finger type Linear guide specification Air hands**

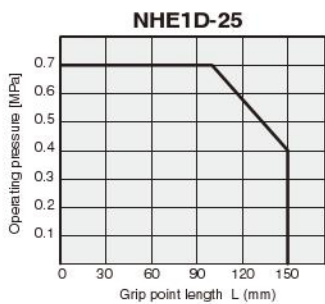
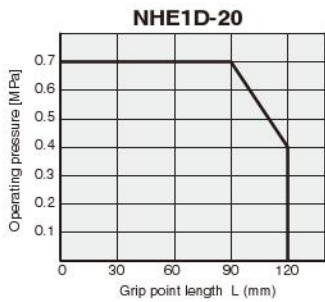
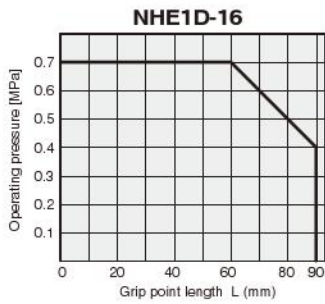

1mm = 0.0394in.
1MPa = 145psi.

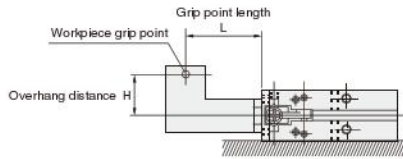

● **Parallel type Cross roller bearing specification**

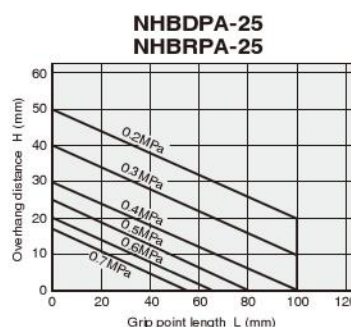
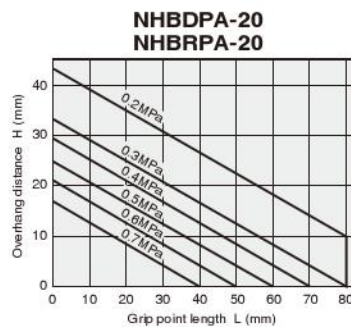
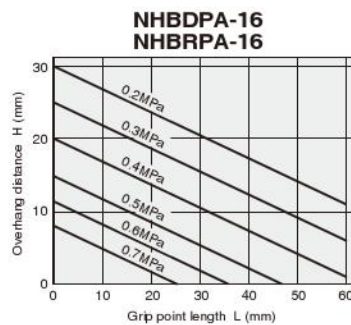
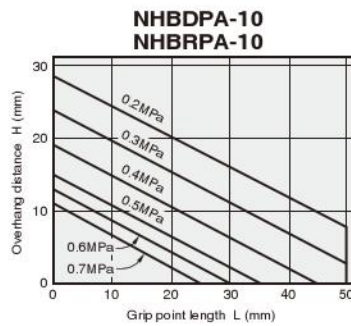
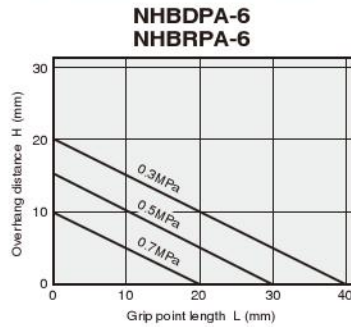

1mm = 0.0394in. 1MPa = 145psi.

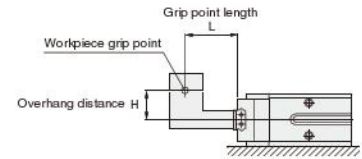

● **Parallel type Linear guide specification (with rubber cover)**

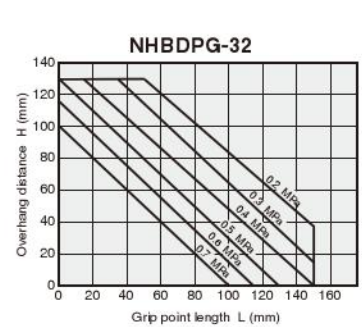
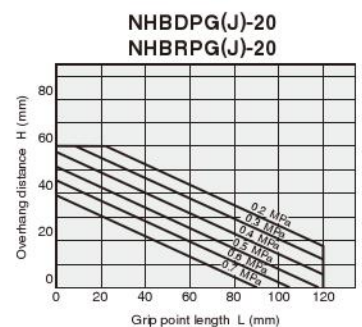
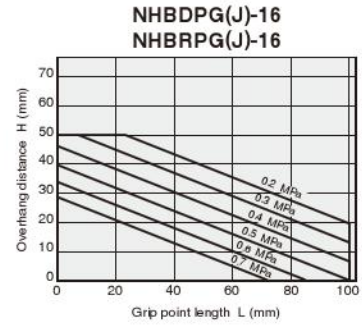
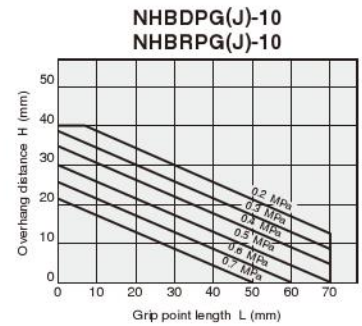
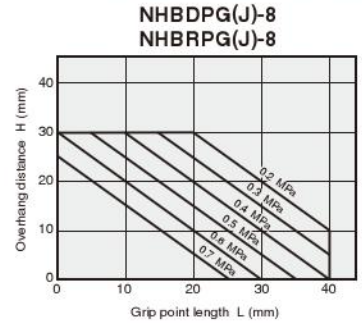

1mm = 0.0394in. 1MPa = 145psi.

Grip point limit range

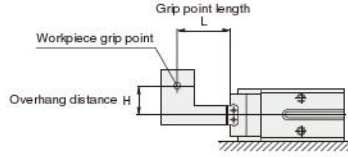

● Linear guide specification Long stroke

NHBDPGL-8

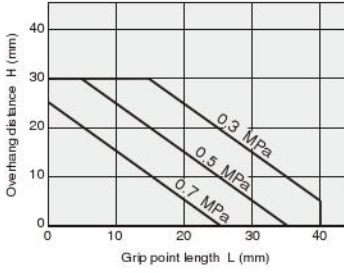

NHBDPGL-10

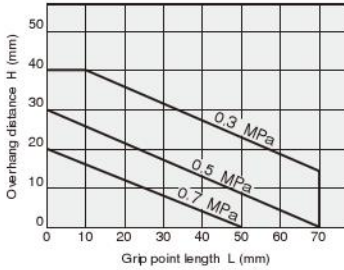

NHBDPGL-16

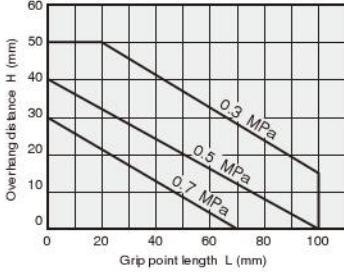

NHBDPGL-20

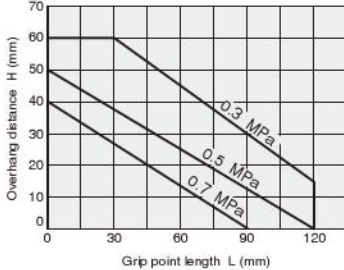

1mm = 0.0394in.
1MPa = 145psi.

● Linear guide specification With fingers

**NHBDPGY-8
NHBRPGY-8**

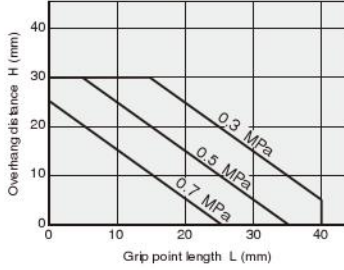

**NHBDPGY-10
NHBRPGY-10**

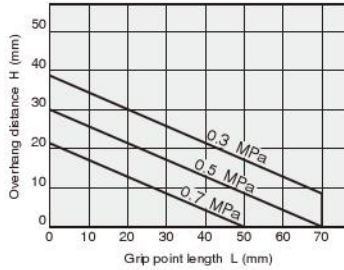

**NHBDPGY-16
NHBRPGY-16**

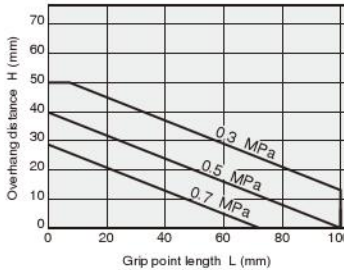

**NHBDPGY-20
NHBRPGY-20**

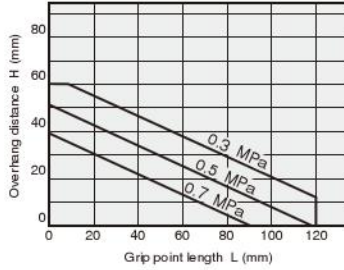

1mm = 0.0394in.
1MPa = 145psi.

● Linear guide specification for clean systems

CS-NHBDPG-8

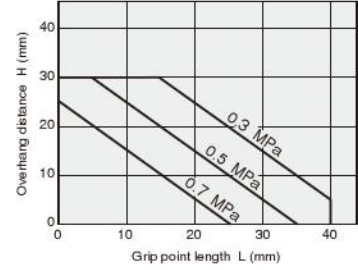

CS-NHBDPG-10

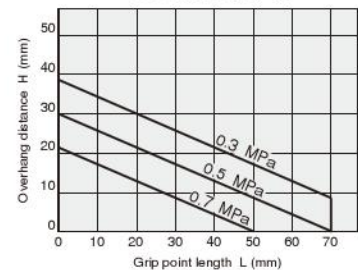

CS-NHBDPG-16

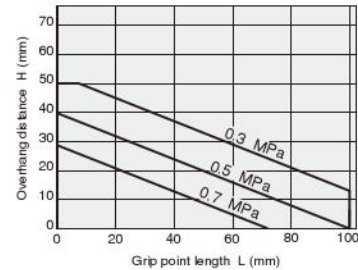

CS-NHBDPG-20

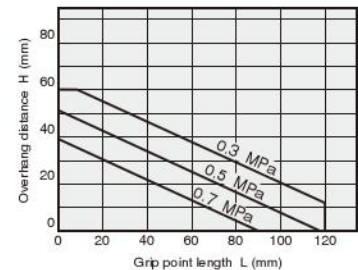

1mm = 0.0394in.
1MPa = 145psi.

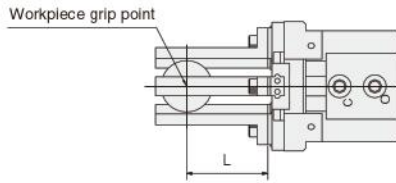

● Parallel type
Linear guide specification
Mechanical hands

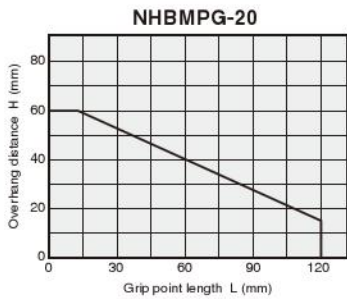
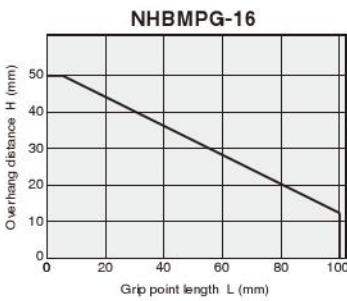
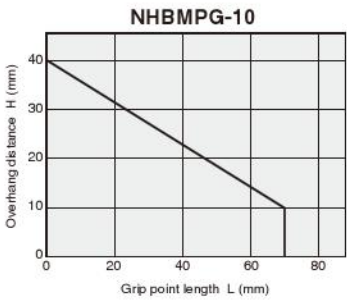
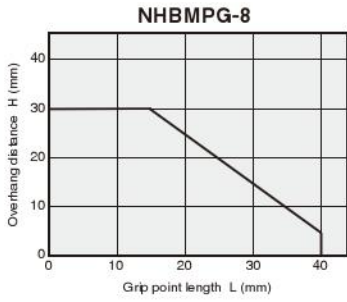

1mm = 0.0394in.

● Three-finger type
Linear guide specification
Mechanical hands

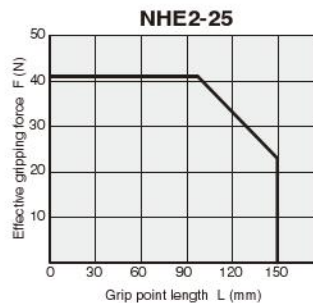
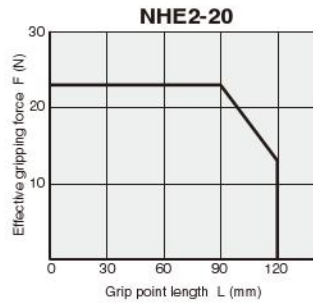
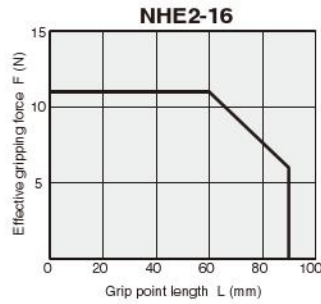

1N = 0.2248lbf.
 1mm = 0.0394in.

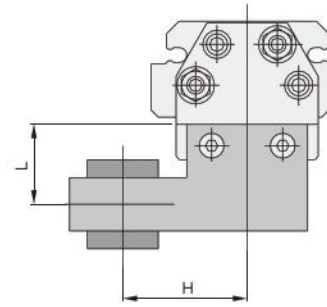

H = Overhang distance
 L = Grip point length

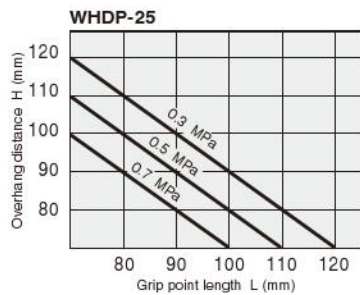
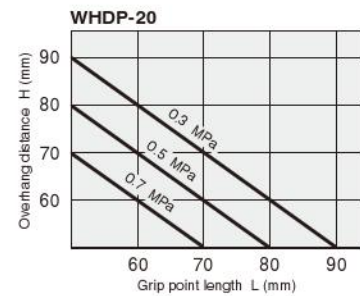
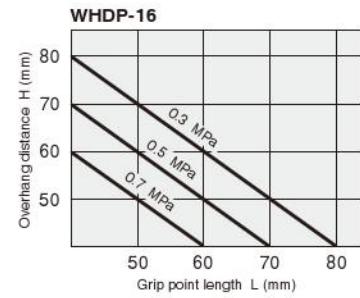
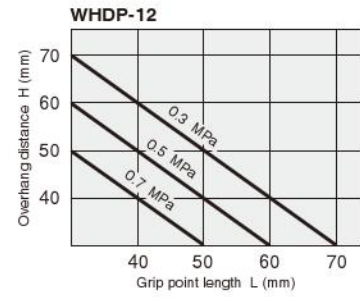

1mm = 0.0394in. 1MPa = 145psi.

Handling Instructions and Precautions

Allowable load and allowable moment

Linear guide specification

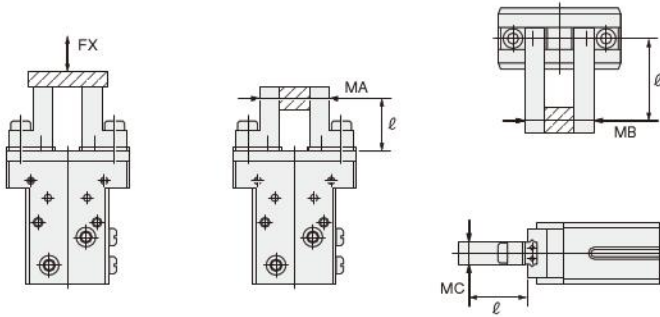

NHB series

Model	Load and moment			
	FX N [lbf.]	MA N·m [in·lbf]	MB N·m [in·lbf]	MC N·m [in·lbf]
(CS-)NHB□P□□-8	12 [2.7]	0.04 [0.4]	0.04 [0.4]	0.08 [0.7]
(CS-)NHB□P□□-10	49 [11.0]	0.39 [3.5]	0.39 [3.5]	0.78 [6.9]
(CS-)NHB□P□□-16	117 [26.3]	0.98 [8.7]	0.98 [8.7]	1.96 [17.3]
(CS-)NHB□P□□-20	196 [44.1]	1.47 [13.0]	1.47 [13.0]	2.94 [26.0]
NHBDPG-32	350 [78.7]	3 [26.6]	3 [26.6]	6 [53.1]

Remark: l is the distance from the main body end to the gripping point.

NHC1 series

Model	Load and moment			
	FX N [lbf.]	MA N·m [in·lbf]	MB N·m [in·lbf]	MC N·m [in·lbf]
NHC1D-10	60 [13.5]	0.3 [2.7]	0.3 [2.7]	0.6 [5.3]
NHC1D-16	100 [22.5]	0.8 [7.1]	0.8 [7.1]	1.6 [14.2]
NHC1D-20	160 [36.0]	1.4 [12.4]	1.4 [12.4]	2.8 [24.8]
NHC1D-25	280 [62.9]	2.4 [21.2]	2.4 [21.2]	4.8 [42.5]

Remark: l is the distance from the main body end to the gripping point.

Three-finger type linear guide specification

Model	Load and moment			
	FX N [lbf.]	MA N·m [in·lbf]	MB N·m [in·lbf]	MC N·m [in·lbf]
NHE1D-16	50 [11.2]	0.4 [3.5]	0.4 [3.5]	0.8 [7.1]
NHE1D-20	120 [27.0]	1 [8.9]	1 [8.9]	2 [17.7]
NHE1D-25	200 [45.0]	1.5 [13.3]	1.5 [13.3]	3 [26.6]

WHDP series

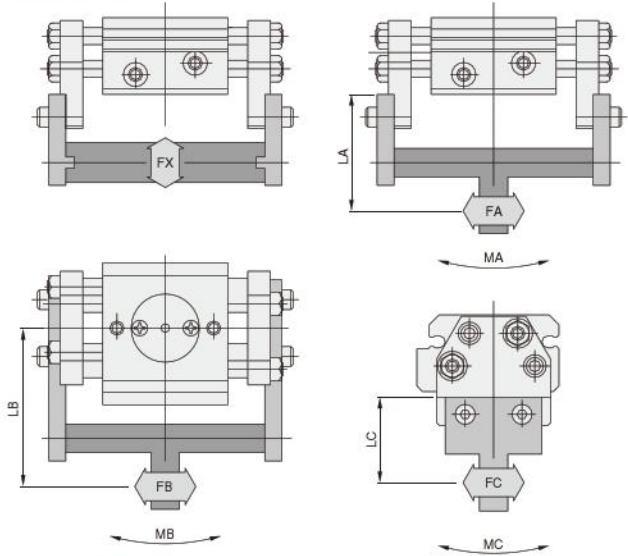

- $MA = FX \times LA$ (N·m)
- $MB = FB \times LB$ (N·m)
- $MC = FC \times LC$ (N·m)

Model	Load and moment			
	FX N [lbf.]	MA N·m [in·lbf]	MB N·m [in·lbf]	MC N·m [in·lbf]
WHDP-12	24 [5.4]	0.6 [5.3]	0.6 [5.3]	0.12 [1.06]
WHDP-16	36 [8.1]	1.1 [9.7]	1.1 [9.7]	0.22 [1.95]
WHDP-20	68 [15.3]	2.1 [18.6]	2.1 [18.6]	0.49 [4.34]
WHDP-25	93 [20.9]	2.7 [23.9]	2.7 [23.9]	0.76 [6.73]

Gripping

- When attaching fingers on the levers, design them as short and as light as possible. If the fingers are longer and heavier, the impact force when opening and closing will increase and cause a decrease in the gripping accuracy and/or wear and damage to the sliding portion. Also, to prevent the workpiece from falling down or being damaged, and to reduce the metal contact noise when gripping, plastic or rubber materials should be attached to the fingers at the part of contact.
In cases with long grip point length or high air pressure, there will be a large gripping moment exerted on the lever area that could result in damage to the lever. Always refer to the grip point limit range table, and use it within the allowed range.
- When the lever opening and closing time is faster than necessary in relation to the workpieces, the impact force increases when opening and/or closing and causes a decrease in the gripping accuracy, and wear and damage of the sliding portion etc., therefore a speed controller should be installed and the workpiece should be gripped to make the impact as small as possible.
- When moving the air gripper in straight lines or during circular operations, use a shock absorber etc., at the travel end to stop it as smoothly as possible. Sudden stops may cause the workpieces to pop out or fall from the gripper.
- When installing the fingers on the lever, use a wrench etc., to hold it so that the lever doesn't get twisted. Tighten the mounting bolts to the tightening torques shown in the table below.

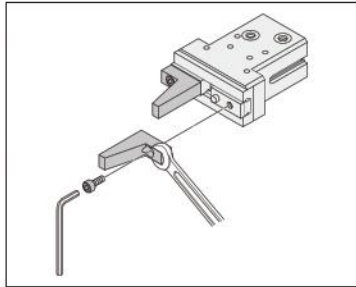

● NHC1 series

Model	Bolt	Maximum tightening torque N · m [in · lbf]
NHC1D-10	M3 × 0.5	0.6 [5.3]
NHC1D-16	M4 × 0.7	1.4 [12.4]
NHC1D-20	M5 × 0.8	2.9 [25.7]
NHC1D-25	M6 × 1.0	4.8 [42.5]

Caution: Avoid applications in which side loads are applied to the lever and lever mounting portion.

● NHB series (Linear guide specification)

Model	Bolt	Maximum tightening torque N · m [in · lbf]
(CS-)NHB□PG(L)-8	M2 × 0.4	0.15 [1.33]
(CS-)NHB□PG(L)-10	M3 × 0.5	0.6 [5.3]
(CS-)NHB□PG(L)-16	M4 × 0.7	1.4 [12.4]
(CS-)NHB□PG(L)-20	M5 × 0.8	2.9 [25.7]
NHBDPG-32	M6 × 1	4.8 [42.5]

Caution: Avoid applications in which side loads are applied to the lever and lever mounting portion.

● NHB series (High precision, 180° open specification)

Model	Bolt	Maximum tightening torque N · m [in · lbf]
NHBDSL-12	M3 × 0.5	0.6 [5.3]
NHBDSL-16	M3 × 0.5	0.6 [5.3]
NHBDSL-20	M4 × 0.7	1.4 [12.4]

Caution: Avoid applications in which side loads are applied to the lever and lever mounting portion.

● Three-finger type linear guide specification

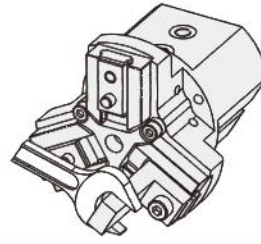

Model	Bolt	Maximum tightening torque N · m [in · lbf]
NHE1D/NHE2-16	M3 × 0.5	0.6 [5.3]
NHE1D/NHE2-20	M4 × 0.7	1.4 [12.4]
NHE1D/NHE2-25	M5 × 0.8	3.0 [26.6]

Caution: Avoid applications in which side loads are applied to the lever and lever mounting portion.

Workpiece

- NHB series (linear guide specification)
- Three-finger type (linear guide specification)

- Set the mass of the workpiece actually gripped to about 1/10~1/20 of the effective gripping force.
- Set the workpiece mass to about 1/30~1/50 of the effective gripping force when you move the air gripper while holding the workpiece.
- As the workpiece mass which can be gripped changes greatly depending on the material and shape of the fingers, the condition of the gripping surface and the moving speed of the workpiece, etc., the values in the specifications and graphs should be used for reference only.

Handling Instructions and Precautions

Body mounting method

● NHC1

1. Method for using body through holes. (Sensor switches cannot be mounted.)

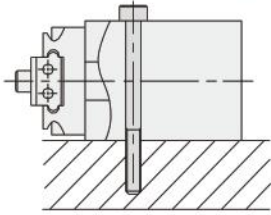

Model	Bolt	Maximum tightening torque N · m [in · lbf]
NHC1D-10	M3 × 0.5	0.6 [5.3]
NHC1D-16	M3 × 0.5	0.6 [5.3]
NHC1D-20	M4 × 0.7	1.4 [12.4]
NHC1D-25	M5 × 0.8	2.9 [25.7]

2. Method for using mounting threads on top or bottom of the body.

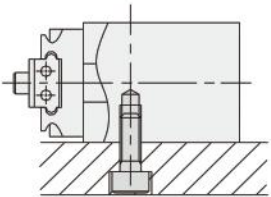

Model	Bolt	Maximum tightening torque N · m [in · lbf]
NHC1D-10	M4 × 0.7	1.4 [12.4]
NHC1D-16	M4 × 0.7	1.4 [12.4]
NHC1D-20	M5 × 0.8	2.9 [25.7]
NHC1D-25	M6 × 1.0	4.8 [42.5]

3. Method for using mounting threads on side surface of the body.

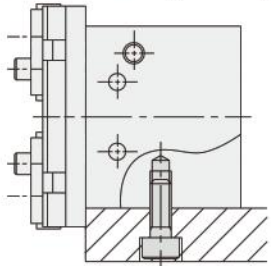

Model	Bolt	Maximum tightening torque N · m [in · lbf]
NHC1D-10	M3 × 0.5	0.6 [5.3]
NHC1D-16	M4 × 0.7	1.4 [12.4]
NHC1D-20	M5 × 0.8	2.9 [25.7]
NHC1D-25	M6 × 1.0	4.8 [42.5]

4. Method for using mounting threads on the head cover side of the body. (Some space is required in this case, however, because the sensor switch protrudes.)

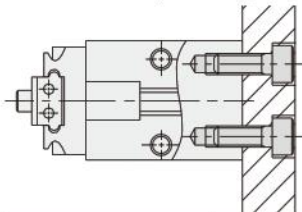

Model	Bolt	Maximum tightening torque N · m [in · lbf]
NHC1D-10	M3 × 0.5	0.6 [5.3]
NHC1D-16	M4 × 0.7	1.4 [12.4]
NHC1D-20	M5 × 0.8	2.9 [25.7]
NHC1D-25	M6 × 1.0	4.8 [42.5]

※ In examples 1, 2, and 4, locating holes can also be used. For the hole dimensions, see the Dimensions.

● NHB series (linear guide specification)

1. Method for using body through holes.

(On $\phi 8$ [0.315in.], $\phi 10$ [0.394in.], $\phi 16$ [0.630in.], $\phi 20$ [0.787in.], and $\phi 25$ [0.984in.] sensor switches cannot be mounted)

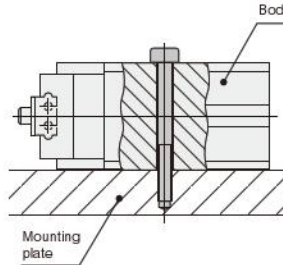

2. Method for using mounting threads on back surface of the body.

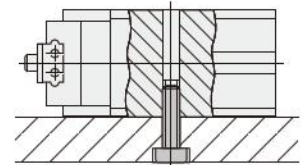

※ In examples 1 and 2, locating holes on the opposite side can also be used.

3. Method for using mounting threads on side surface of the body.

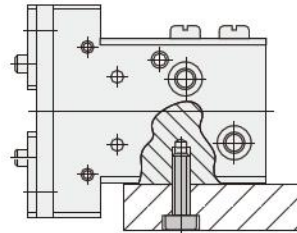

4. Method for using mounting threads on the head cover side of the body. (Some space is required in this case, however, because the sensor switch protrudes.)

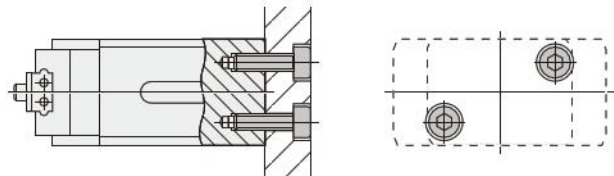

5. Method for using mounting threads on the lever side of the body. (Not available in $\phi 8$ [0.315in.].)

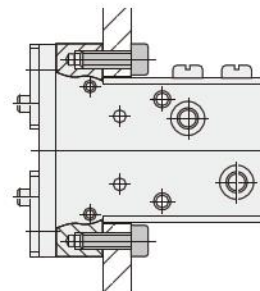

● **NHB series (High precision, 180° open specification)**

1. Method for using body through holes.
(Sensor switches cannot be mounted.)

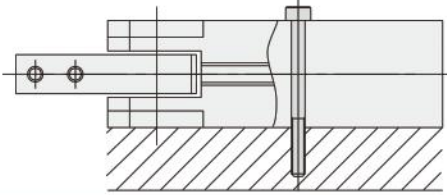

Model	Bolt	Maximum tightening torque N · m [in · lbf]
NHBDSL \bar{G} -12	M3 × 0.5	0.6 [5.3]
NHBDSL \bar{G} -16	M3 × 0.5	0.6 [5.3]
NHBDSL \bar{G} -20	M4 × 0.7	1.4 [12.4]

2. Method for using mounting threads on top or bottom of the body.

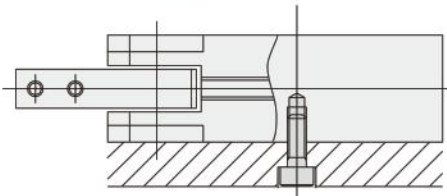

Model	Bolt	Maximum tightening torque N · m [in · lbf]
NHBDSL \bar{G} -12	M4 × 0.7	1.4 [12.4]
NHBDSL \bar{G} -16	M4 × 0.7	1.4 [12.4]
NHBDSL \bar{G} -20	M5 × 0.8	2.9 [25.7]

3. Method for using mounting threads on side surface of the body.

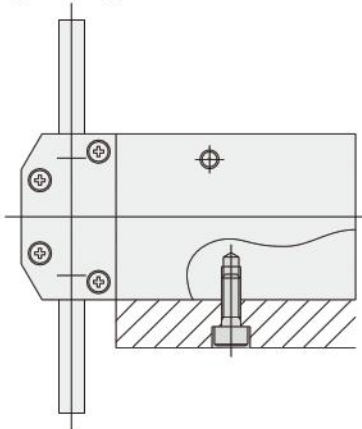

Model	Bolt	Maximum tightening torque N · m [in · lbf]
NHBDSL \bar{G} -12	M3 × 0.5	0.6 [5.3]
NHBDSL \bar{G} -16	M4 × 0.7	1.4 [12.4]
NHBDSL \bar{G} -20	M5 × 0.8	2.9 [25.7]

4. Method for using mounting threads on the head cover side of the body.

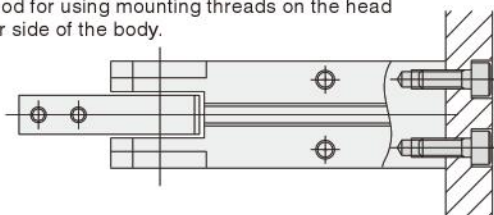

Model	Bolt	Maximum tightening torque N · m [in · lbf]
NHBDSL \bar{G} -12	M3 × 0.5	0.6 [5.3]
NHBDSL \bar{G} -16	M4 × 0.7	1.4 [12.4]
NHBDSL \bar{G} -20	M5 × 0.8	2.9 [25.7]

※ For Example 4, the locating hole can be used.
For the hole dimensions, see the Dimensions on p.1441-1442.

● **Three-finger type linear guide specification (Air hand NHE1D)**

1. Method for using body through holes.

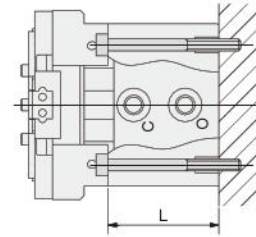

Bore mm	Bolt	Maximum tightening torque N · m [in · lbf]	L mm [in.]
16	M3 × 0.5	0.6 [5.3]	28 [1.102]
20	M3 × 0.5	0.6 [5.3]	34 [1.339]
25	M4 × 0.7	1.4 [12.4]	40 [1.575]

2. Method for using mounting threads on the back side of the through holes.

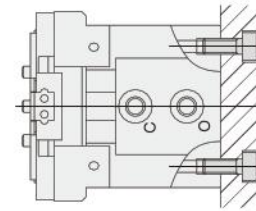

Bore mm	Bolt	Maximum tightening torque N · m [in · lbf]
16	M4 × 0.7	1.4 [12.4]
20	M4 × 0.7	1.4 [12.4]
25	M5 × 0.8	3.0 [26.6]

3. For locating hole dimensions (use for locating at time of mounting), see the page of dimensions.

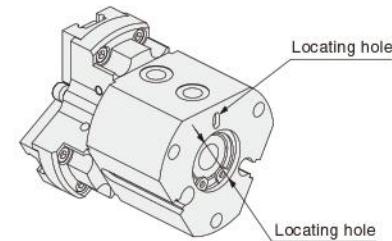

● **Three-finger type linear guide specification (Mechanical hand NHE2)**

1. Method for using body through holes.

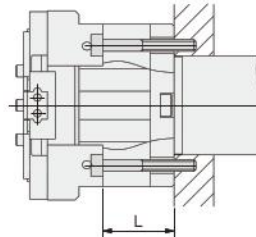

Nominal diameter mm	Bolt	Maximum tightening torque N · m [in · lbf]	L mm [in.]
16	M3 × 0.5	0.6 [5.3]	18 [0.709]
20	M3 × 0.5	0.6 [5.3]	21 [0.827]
25	M4 × 0.7	1.4 [12.4]	21 [0.827]

2. Method for using mounting threads on the back side of the through holes.

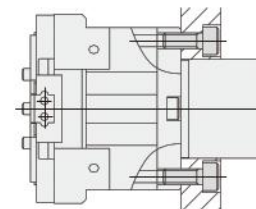

Nominal diameter mm	Bolt	Maximum tightening torque N · m [in · lbf]
16	M4 × 0.7	1.4 [12.4]
20	M4 × 0.7	1.4 [12.4]
25	M5 × 0.8	3.0 [26.6]

3. When using the shank portion.

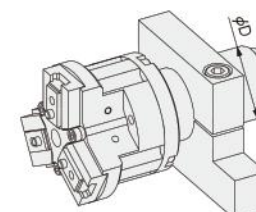

Nominal diameter mm	Shank diameter φ D
16	φ 25 $^{+0.01}_{-0.03}$ [0.9843 $^{+0.0004}_{-0.0012}$]
20	φ 30 $^{+0.01}_{-0.03}$ [1.1811 $^{+0.0004}_{-0.0012}$]
25	φ 30 $^{+0.01}_{-0.03}$ [1.1811 $^{+0.0004}_{-0.0012}$]

WHDP SERIES RACK OPERATION PARALLEL TYPE

Wide Type Air Hands, Double Acting Type

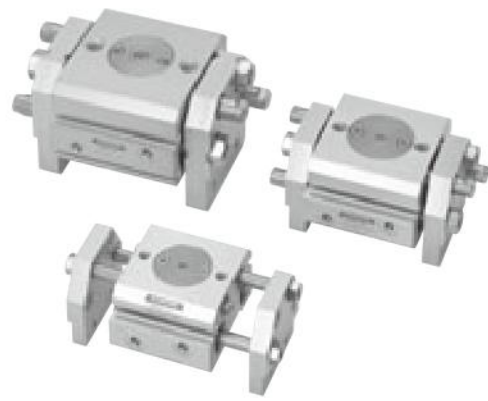

Specifications

● Double acting rack operation parallel type

Basic model		WHDP-12	WHDP-16	WHDP-20	WHDP-25
Item					
Cylinder bore size	mm [in.]	12 [0.472]	16 [0.630]	20 [0.787]	25 [0.984]
Operation type		Double acting type			
Media		Air			
Operating pressure range	MPa [psi.]	0.2~0.7 [29~102]			
Proof pressure	MPa [psi.]	1.05 [152]			
Operating temperature range	°C [°F]	0~60 [32~140]			
Maximum operating frequency	cycle/min	120			
Lubrication		Not required			
Effective gripping force (F) ^{Note}	N [lbf.]	24 [5.4]	48 [10.8]	82 [18.4]	132 [29.7]
Lever open/closed stroke	mm [in.]	24 [0.945]	32 [1.260]	40 [1.575]	50 [1.969]
Repeatability	mm [in.]	±0.08 [±0.0031]			
Port size		M5×0.8			
Mass	g [oz.]	230 [8.1]	400 [14.1]	760 [26.8]	1100 [38.8]

Note: Values are obtained when grip point length is 50mm [1.97in.] under operating pressure 0.5 MPa [73psi].
For details of the effective gripping force, see the graphs on p.1391.

Order Codes

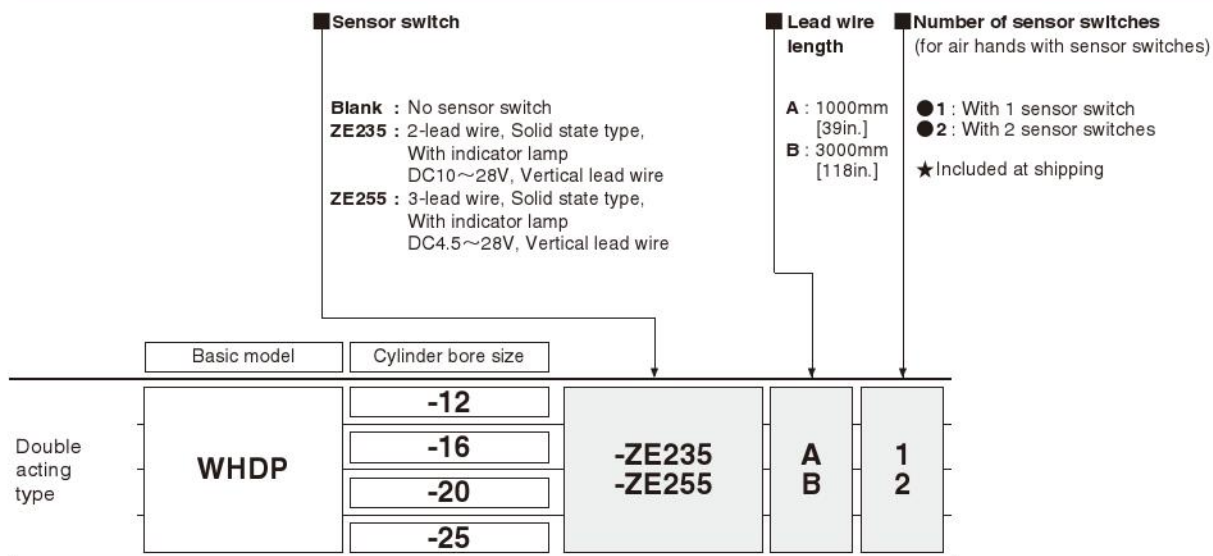

Inner Construction

● Diagrams show double acting type $\phi 12$ [0.472in.].

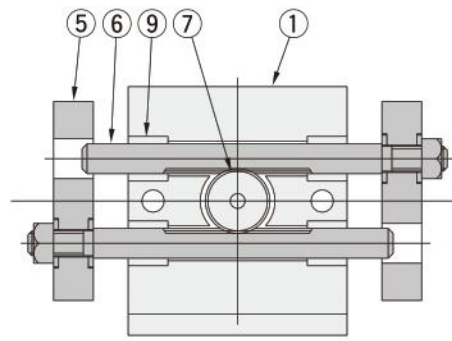

Section A - A'

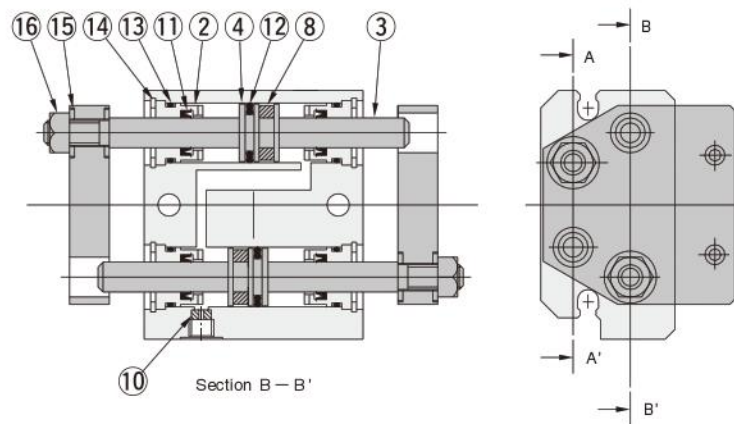

Section B - B'

Major Parts and Materials

No.	Parts	Materials
①	Body	Aluminum alloy
②	Rod cover	Aluminum alloy
③	Piston rod	Stainless steel
④	Piston	Aluminum alloy
⑤	Lever	Aluminum alloy
⑥	Guide rod	Stainless steel
⑦	Pinion	Stainless steel
⑧	Magnet	Plastic magnet

No.	Parts	Materials
⑨	Metal bushing	Bearing copper alloy
⑩	Fixed throttle	Aluminum alloy
⑪	Seal	Synthetic rubber
⑫	Seal	Synthetic rubber
⑬	O-ring	Synthetic rubber
⑭	Snap ring	Carbon tool steel
⑮	Plain washer	Stainless steel
⑯	Hexagon nut	Mild steel

Dimensions of Rack Operation Parallel Type (mm)

WHDP-12

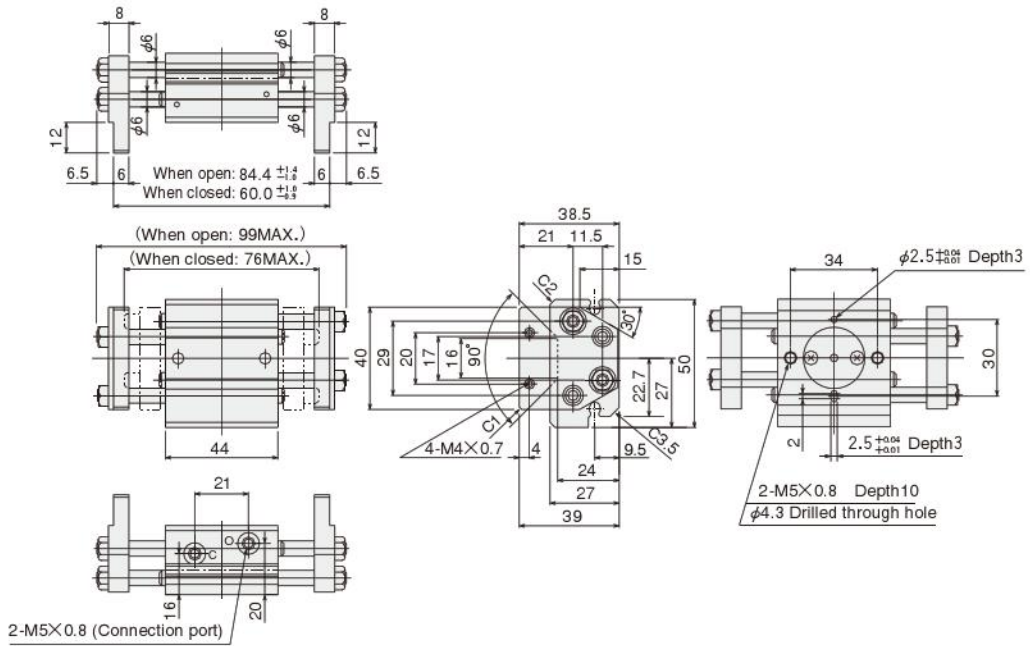

WHDP-16

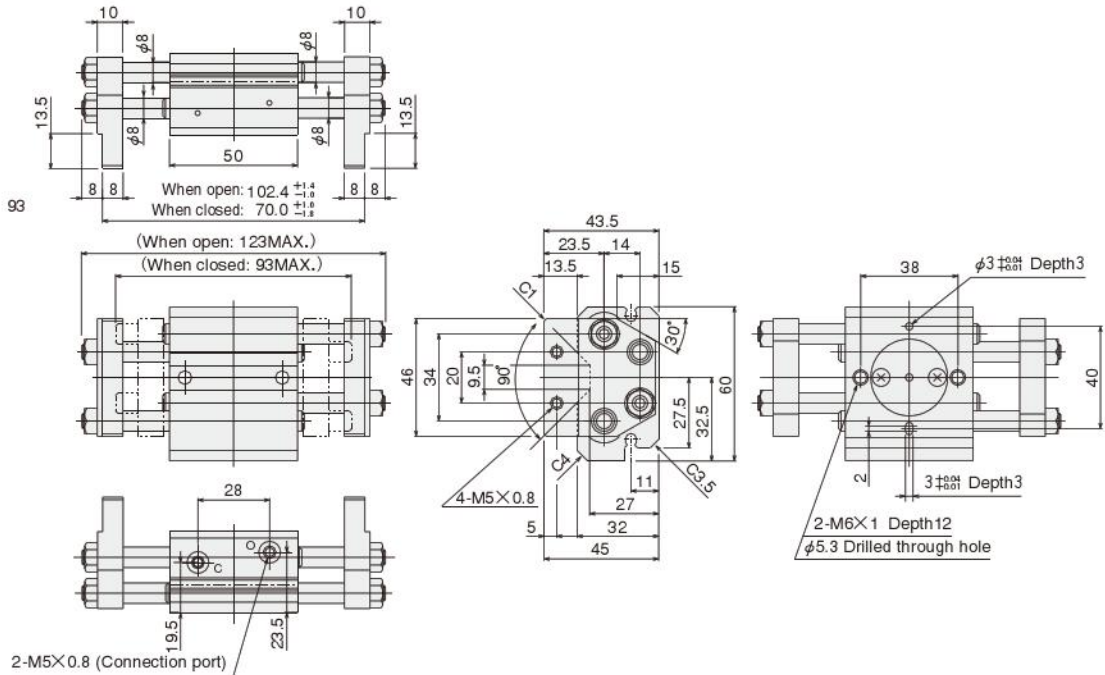

Dimensions of Rack Operation Parallel Type (mm)

WHDP-20

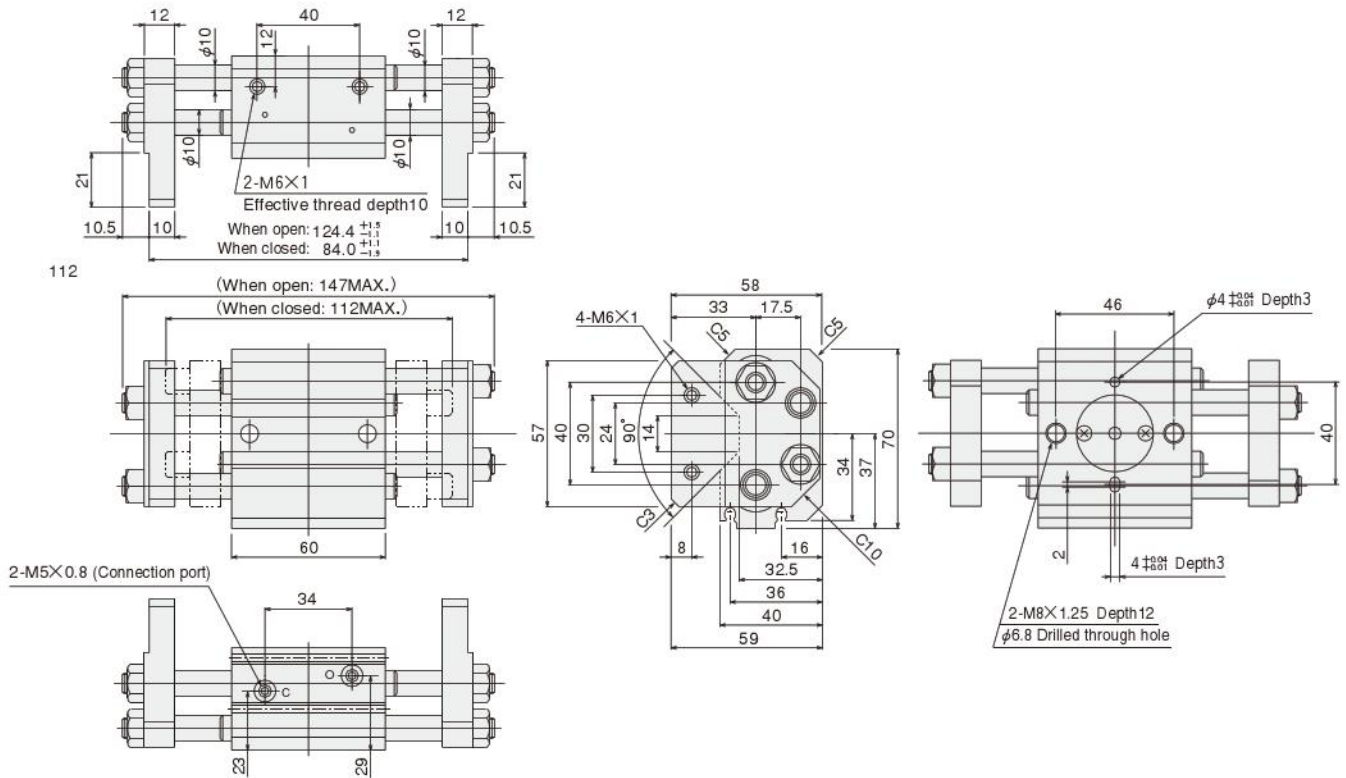

WHDP-25

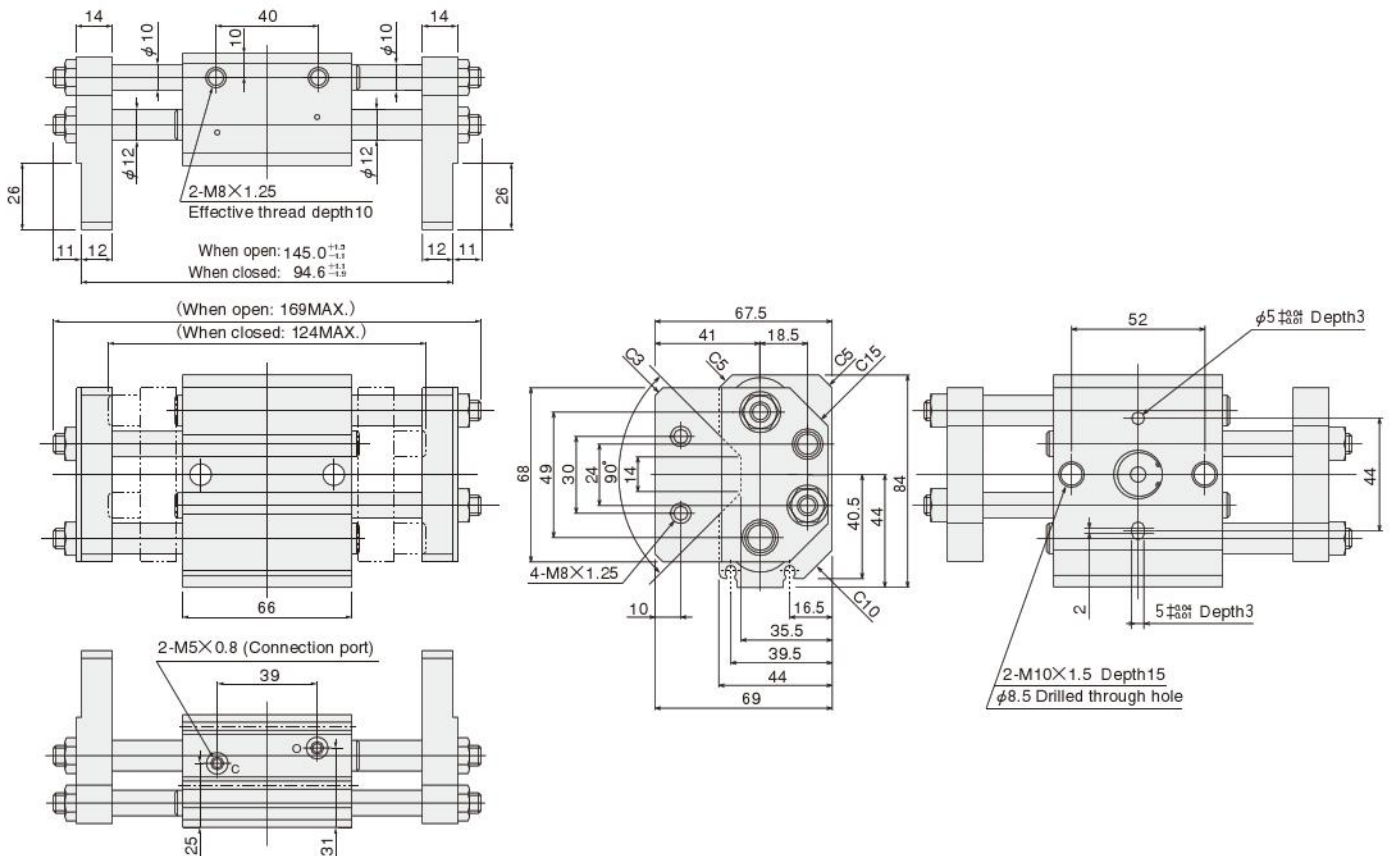

AIR HANDS SERIES

SENSOR SWITCHES

Solid State Type

Symbol

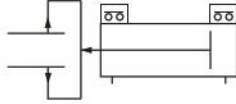

Order Codes

● Sensor switch only

● NHC1 series



Lead wire length
A — 1000mm [39in.]
B — 3000mm [118in.]

Sensor switch —
ZE135 — Solid state type 2-lead wire with indicator lamp DC10~28V Horizontal lead wire
ZE235 — Solid state type 2-lead wire with indicator lamp DC10~28V Vertical lead wire
ZE155 — Solid state type 3-lead wire with indicator lamp DC4.5~28V Horizontal lead wire
ZE255 — Solid state type 3-lead wire with indicator lamp DC4.5~28V Vertical lead wire

● NHB series



Lead wire length
A — 1000mm [39in.]
B — 3000mm [118in.]

Sensor switch —
ZE135 — Solid state type 2-lead wire
ZE235 — Solid state type 2-lead wire
ZE155 — Solid state type 3-lead wire
ZE255 — Solid state type 3-lead wire

● WHDP series

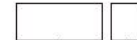

Lead wire length
A — 1000mm [39in.]
B — 3000mm [118in.]

Sensor switch —
ZE235 — Solid state type 2-lead wire
ZE255 — Solid state type 3-lead wire

● Three-finger type linear guide specification (air hands)



Lead wire length
A — 1000mm [39in.]
B — 3000mm [118in.]

Sensor switch —
ZE135 — Solid state type 2-lead wire with indicator lamp DC10~28V Horizontal lead wire
ZE235 — Solid state type 2-lead wire with indicator lamp DC10~28V Vertical lead wire
ZE155 — Solid state type 3-lead wire with indicator lamp DC4.5~28V Horizontal lead wire
ZE255 — Solid state type 3-lead wire with indicator lamp DC4.5~28V Vertical lead wire

Caution: Sensor switch cannot be mounted on the mechanical hands.

● For details of sensor switches, see p.1544.

Sensor Switch Operating Range and Response Differential

● Open/closed stroke differential (Open/closed angle differential)

The stroke differential (angle differential) between the point where the lever on one side moves and turns the switch ON and the point where the switch is turned OFF as the lever travels in the opposite direction.

● Operating position repeatability

When the lever on one side moves in the same direction, operating position repeatability is defined as the range of the deviation of the position where the switch is turned ON or turned OFF.

Parallel type linear guide specification

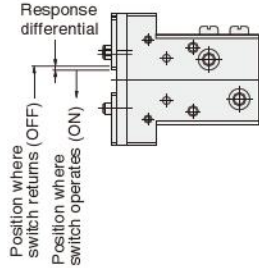

Parallel type

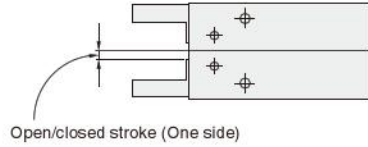

Swing type

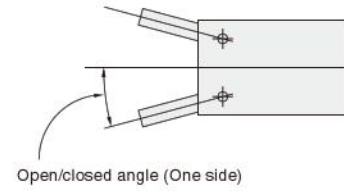

Rack operation parallel type

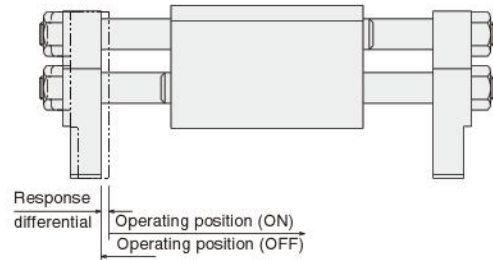

● NHC1 series

mm [in.]

Model	Open/closed stroke differential	Operating position repeatability
NHC1D-10	0.2 [0.008]	0.1 [0.004]
NHC1D-16	0.2 [0.008]	0.1 [0.004]
NHC1D-20	0.2 [0.008]	0.1 [0.004]
NHC1D-25	0.2 [0.008]	0.1 [0.004]

Remark: The above table shows reference values.

● Parallel type

mm [in.]

Model	Open/closed stroke differential	Operating position repeatability
NHB□PA-6	0.5 [0.020]	0.2 [0.008]
NHB□P□-10	0.5 [0.020]	0.2 [0.008]
NHB□P□-16	0.6 [0.024]	0.2 [0.008]
NHB□P□-20	0.6 [0.024]	0.2 [0.008]
NHB□P□-25	0.6 [0.024]	0.2 [0.008]

Remark: The above table shows reference values.

● Parallel type linear guide specification (with rubber cover)

mm [in.]

Model	Open/closed stroke differential	Operating position repeatability
NHB□PG(J)-8	0.5 [0.020]	0.2 [0.008]
NHB□PG(J)-10	0.5 [0.020]	0.2 [0.008]
NHB□PG(J)-16	0.8 [0.031]	0.2 [0.008]
NHB□PG(J)-20	0.8 [0.031]	0.2 [0.008]
NHBDPG-32	0.8 [0.031]	0.2 [0.008]

Remark: The above table shows reference values.

● Rack operation parallel type

mm [in.]

Model	Open/closed stroke differential	Operating position repeatability
WHDP-12	0.6 [0.024]	0.2 [0.008]
WHDP-16	0.6 [0.024]	0.2 [0.008]
WHDP-20	0.5 [0.020]	0.2 [0.008]
WHDP-25	0.5 [0.020]	0.2 [0.008]

Remark: The above table shows reference values.

● Swing type

Model	Open/closed angle differential	Operating position repeatability
NHB□S-8	3.0°	1.0°
NHB□S-10	2.0°	1.0°
NHB□S-16	1.5°	0.6°
NHB□S-20	1.5°	0.5°
NHB□S-25	1.0°	0.5°

Remark: The above table shows reference values.

● Swing type 180° open specification

Model	Open/closed angle differential	Operating position repeatability
NHBDSL-12	1.5°	0.5°
NHBDSL-16	1.0°	0.25° (one side)
NHBDSL-20	2.0°	0.2° (one side)
NHBDSL-25	3.0°	0.5°

Remark: The above table shows reference values.

● Swing type high precision, 180° open specification

Model	Open/closed angle differential	Operating position repeatability
NHBDSL-12	3.0°	0.5°
NHBDSL-16	1.5°	0.5°
NHBDSL-20	2.5°	0.5°

Remark: The above table shows reference values.

● Three-finger type linear guide specification (air hands)

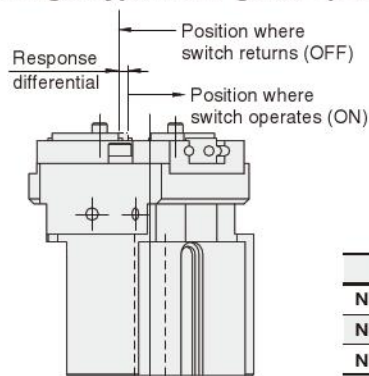

mm [in.]

Model	Maximum response differential
NHE1D-16	0.5 [0.020]
NHE1D-20	0.6 [0.024]
NHE1D-25	0.5 [0.020]

Mounting Sensor Switch

● NHB series

Tighten the mounting screw after the sensor switch is inserted in the switch mounting groove in the direction of the arrow in the diagram and move to the proper location. Tightening torque of the mounting screw is $0.1 \sim 0.2\text{N} \cdot \text{m}$ [$0.9 \sim 1.8\text{in} \cdot \text{lbf}$].

Caution: Care must be exercised that the sensor switch cannot be inserted into the switch mounting groove from the diagram's top direction.

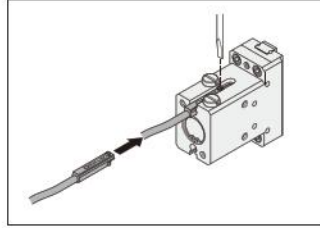

Caution: NHC1 series
NHB□PG(Y, L, J) series
CS-NHBDPG series
NHB□PA series
NHB□S-8
NHBDSLГ series
(Except NHB□PG-32 and NHB□PA-6)
Care must be exercised that a sensor switch cannot be mounted when the body is installed by using thru holes, as shown in the diagram to the right.

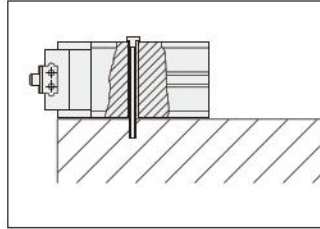

Caution: NHB□PA-25
When using a sensor switch on the lever open side, select the vertical lead wire type ZE235 or ZE255, and mount it in the facing shown in the illustration to the right.

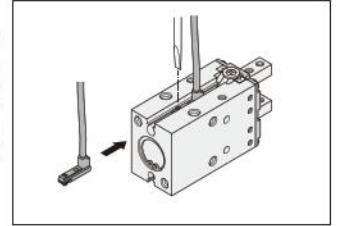

● WHDP series

Tighten the mounting screw after the sensor switch is inserted in the switch mounting groove in the direction of the arrow in the diagram below and move to the proper location. Tightening torque of the mounting screw is $0.1 \sim 0.2\text{N} \cdot \text{m}$ [$0.9 \sim 1.8\text{in} \cdot \text{lbf}$].

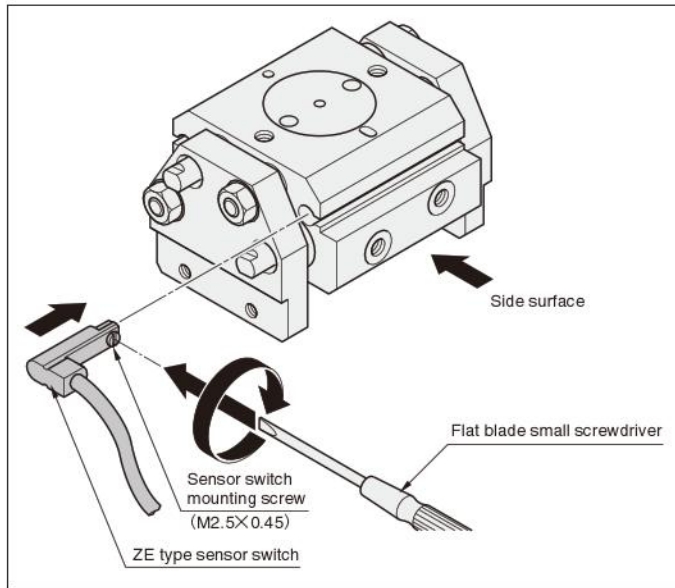

Caution: Care must be exercised that the sensor switch cannot be inserted into the switch mounting groove from the diagram's side surface direction.

● Three-finger type linear guide specification (air hands)

Insert the switch into the switch mounting groove. After setting in the mounting position, use a flat blade small screwdriver to tighten the switch mounting screw. Set the tightening torque to about $0.1 \sim 0.2\text{N} \cdot \text{m}$ [$0.9 \sim 1.8\text{in} \cdot \text{lbf}$]. Be sure to mount the sensor switch so that the side showing the model marking surface faces up.

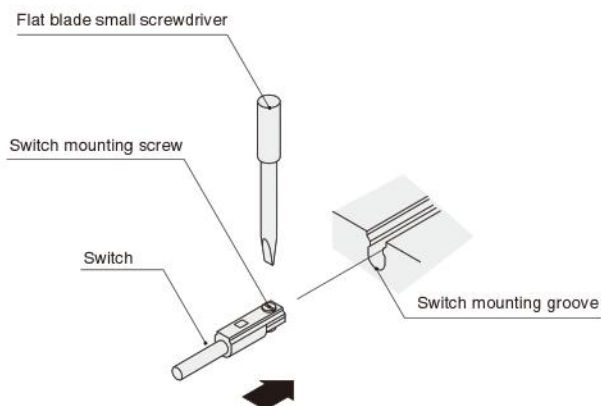

Mounting Sensor Switch

● For swing type (Mount the sensor switch so that the model marking surface faces up.)

《For inside gripping》

- 1) Confirm the levers are completely open.
- 2) Push the switch into the groove on the body in the direction of the arrow.
- 3) By moving the sensor switch in the direction of the arrow, the lamp turns ON, and by moving it further, the lamp turns OFF.
- 4) By moving back the sensor switch in the direction of the arrow (opposite direction), the lamp turns ON, and it should be secured by the sensor switch mounting screw after moving it about 0.3 mm [0.012in.] further.

1) Confirm workpiece is inside gripped one.

《For outside gripping》

- 1) Confirm the levers are completely closed.
- 2) Push the switch into the groove on the body in the direction of the arrow.
- 3) By moving the switch in the direction of the arrow, the lamp turns ON.
- 4) Secure the sensor switch by the mounting screw after moving it about 0.3 mm [0.012in.] further in the direction of the arrow from where the lamp turned ON in step 3).

1) Confirm workpiece is outside gripped one.

Remark: Step 1) shows the location where you want to confirm the switch turns ON. Install and adjust it in accordance with step 1) ~ 4) above.

● For parallel type (Mount the sensor switch so that the model marking surface faces up.)

《For inside gripping》

● For NHBDP□, NHBRP□

- 1) Confirm the levers are completely open.
- 2) Push the switch into the groove on the body in the direction of the arrow.
- 3) By moving the switch in the direction of the arrow, the lamp turns ON.
- 4) Secure the sensor switch by the mounting screw after moving it about 0.3 mm [0.012in.] further in the direction of the arrow from where the lamp turned ON in step 3).

1) Confirm workpiece is inside gripped one.

《For outside gripping》

● For NHBPA□, NHBRPA□

- 1) Confirm the levers are completely closed.
- 2) Push the switch into the groove on the body in the direction of the arrow.
- 3) By moving the sensor switch in the direction of the arrow, the lamp turns ON, and by moving it further, the lamp turns OFF.
- 4) By moving back the sensor switch in the direction of the arrow (opposite direction), the lamp turns ON, and it should be secured by the mounting screw after moving it about 0.3 mm [0.012in.] further.

1) Confirm workpiece is outside gripped one.

《For inside gripping》

● For NHBDP□, NHBRP□

- 1) Confirm the levers are completely open.
- 2) Push the switch into the groove on the body in the direction of the arrow.
- 3) By moving the switch in the direction of the arrow, the lamp turns ON, and by moving it further, the lamp turns OFF.
- 4) By moving back the sensor switch in the direction of the arrow (opposite direction), the lamp turns ON, and it should be secured by the mounting screw after moving it about 0.3 mm [0.012in.] further.

1) Confirm workpiece is inside gripped one.

《For outside gripping》

● For NHBPA□, NHBRPA□

- 1) Confirm the levers are completely closed.
- 2) Push the switch into the groove on the body in the direction of the arrow.
- 3) By moving the switch in the direction of the arrow, the lamp turns ON.
- 4) Secure the sensor switch by the mounting screw after moving it about 0.3 mm [0.012in.] further in the direction of the arrow from where the lamp turned ON in step 3).

1) Confirm workpiece is outside gripped one.

Remark: Step 1) shows the location where you want to confirm the switch turns ON. Install and adjust it in accordance with step 1) ~ 4) above.

● For parallel type linear guide specification (with rubber cover) (Mount the sensor switch so that the model marking surface faces up.)

《For inside gripping》

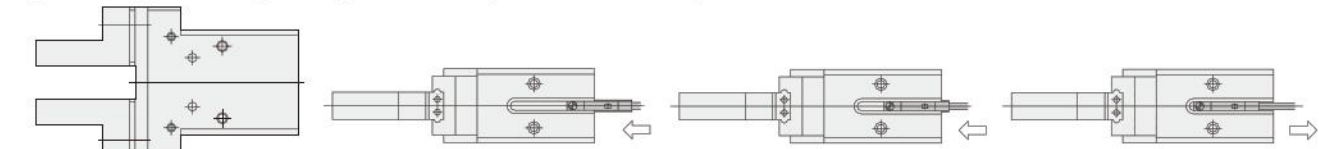
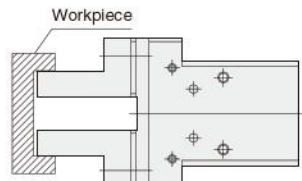
- 
- 1) Confirm the levers are completely open.
 - 2) Insert the switch into the groove on the body in the direction of the arrow.
 - 3) By moving the sensor switch in the direction of the arrow, the lamp turns ON, and by moving it further, the lamp turns OFF.
 - 4) By moving back the sensor switch in the direction of the arrow (opposite direction), the lamp turns ON, and it should be secured by the sensor switch mounting screw after moving it about 0.3 mm [0.012in.] further.
- 
- Workpiece
- 1) Confirm workpiece is inside gripped one.

《For outside gripping》

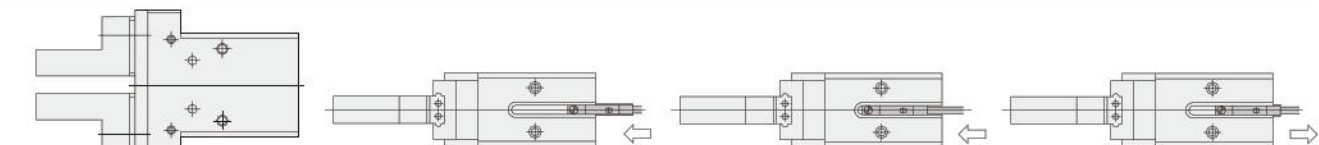
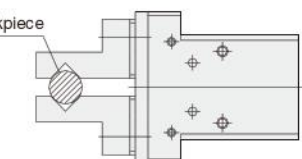
- 
- 1) Confirm the levers are completely closed.
 - 2) Insert the switch into the groove on the body in the direction of the arrow.
 - 3) By moving the switch in the direction of the arrow, the lamp turns ON.
 - 4) Secure the sensor switch by the mounting screw after moving it about 0.3 mm [0.012in.] further in the direction of the arrow from where the lamp turned ON in step 3).
- 
- Workpiece
- 1) Confirm workpiece is outside gripped one.
- Remark: Step 1) shows the location where you want to confirm the switch turns ON. Install and adjust it in accordance with step 1) ~ 4) above.