

人と夢をつなぐクリーンテクノロジー

**KOGANEI**

<http://www.koganei.co.jp>

Catalog No.BK-E0021

**NEW**  
Products

# SmartMini Compressor

Positive Pressure Type (Compressor)  
Negative Pressure Type (Vacuum pump)



**Ideal pressure and vacuum source for robot hands, vacuum pads, and autonomous mobile robots!**

## Compact

The installation area for the horizontal type is  
A5 size (148mm x 210mm) or less!

Simple Operation  
**Plug and Play!**

Lightweight  
2.4kg

Oil-free

## Positive pressure type (Compressor)



Vertical Type



Horizontal Type

## Negative pressure type (Vacuum pump)



Vertical Type



Horizontal Type

# SmartMini Compressor

Positive Pressure Type (Compressor)

Negative Pressure Type (Vacuum pump)

[Size comparison]

Horizontal type

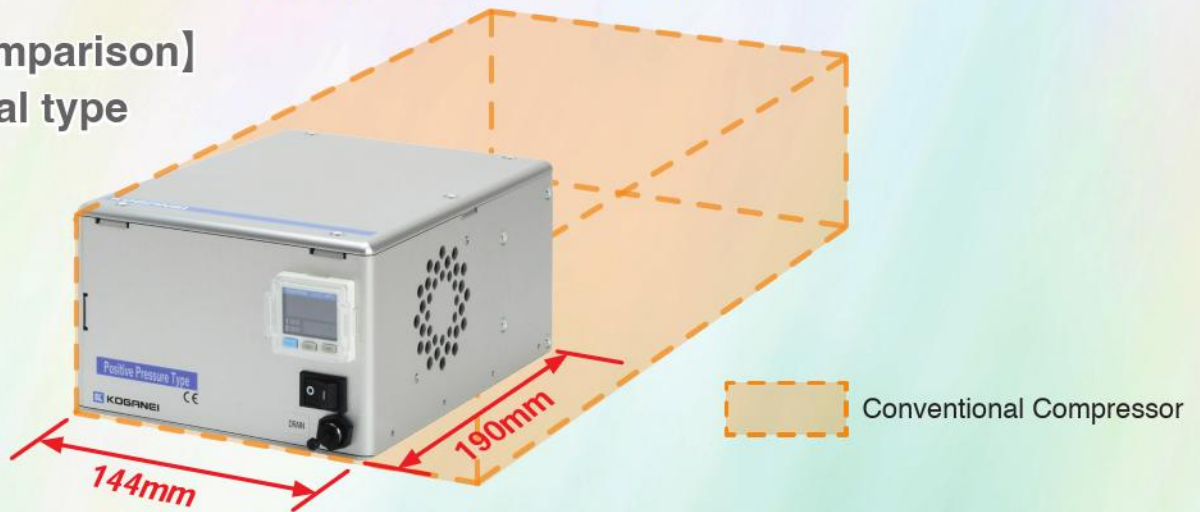

■ Compared to conventional compressors (210 x 297 mm), it has an even smaller, more compact design and approximately twice the flow rate!

\*Installation area (horizontal type) **144x190mm** in **A5 size or smaller!**

■ Quiet operation: Below **50 dB**

■ Oil-free

■ Positive pressure type: Discharge flow rate **4L/min (at 0.5 MPa)**, Maximum pressure **0.6MPa**

■ Negative pressure type: Maximum suction flow rate **10L/min**, the ultimate vacuum pressure **-85kPa**

■ Installation method: With rubber feet, bottom mounting, L-bracket mounting

## Basic Features

### ■ Easy to use

Simply turn on the power to generate positive or negative pressure, and the pump will automatically operate to reach the specified pressure.

#### ● Positive pressure type (compressor)

Unload pressure (stop pressure): 0.6MPa

Load pressure (restart pressure): 0.5MPa

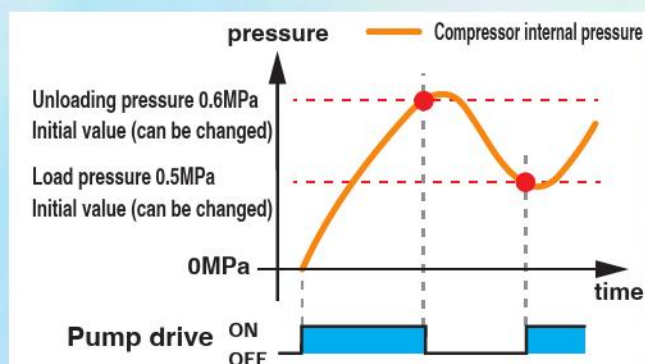

#### ● Negative pressure type (vacuum pump)

Unload pressure (stop pressure): -85kPa

Load pressure (restart pressure): -60kPa

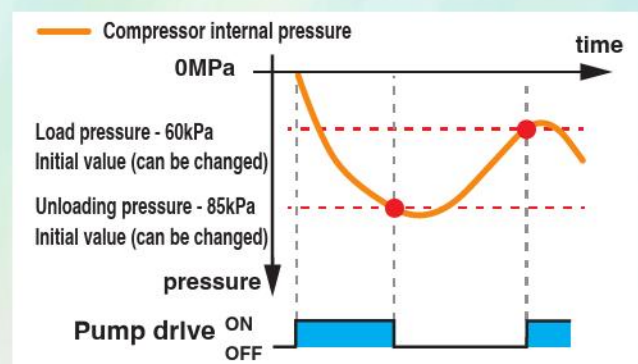

\*The unload pressure and load pressure can be changed by the customer, but the set pressure should be within the specification range.

## Additional Features

■ Equipped with I/O interface (I/O port)

### Input Side

**STOP** : When ON, Motor and fan stop

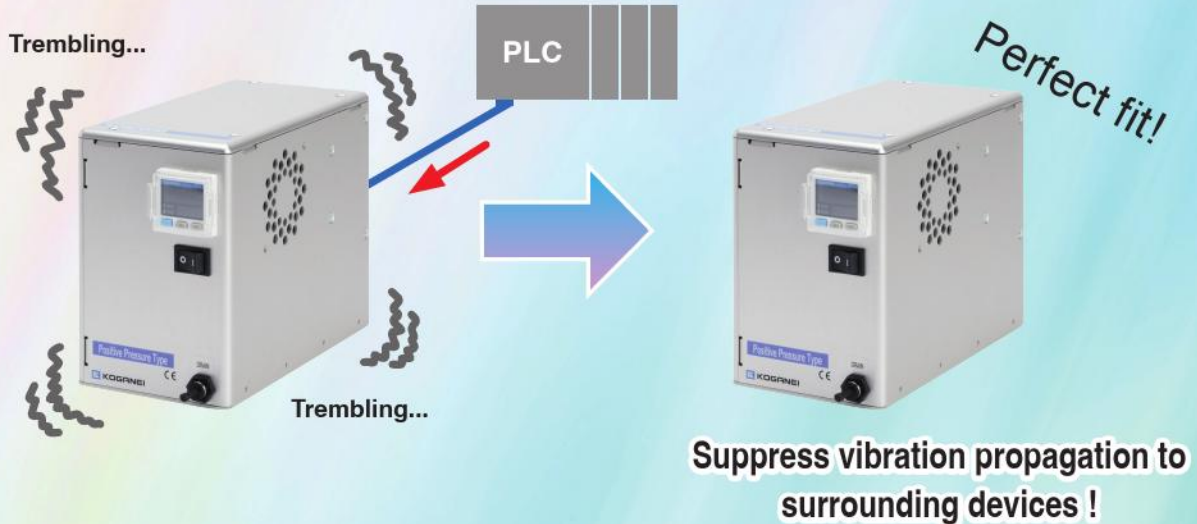

**RESTART** : Turn ON to resume operation

### Output side

**PRESSURE** : ON When pressure is above threshold

\*Initial value: 0.4MPa (Can be changed by the customer)



**ERROR** : Temperature, current, and voltage abnormality detection

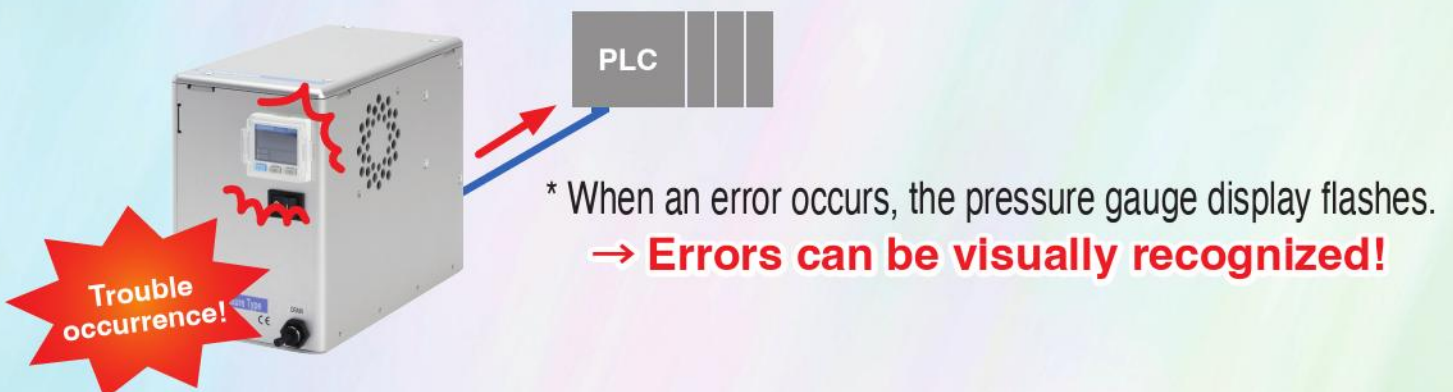

## Additional Features

### ■ Equipped with communication function (communication port)



#### ● Error history can be read

Temperature, current, voltage, and troubleshooting

#### ● I/O control (STOP input, RESTART input) can also be performed via communication

#### ● I/O status (PRESSURE output, ERROR output) can be read via communication

#### ● Accumulated operating time and motor operation time can be read

Predictive maintenance by understanding operation time

## Example Applications

Air source for collaborative robot grips

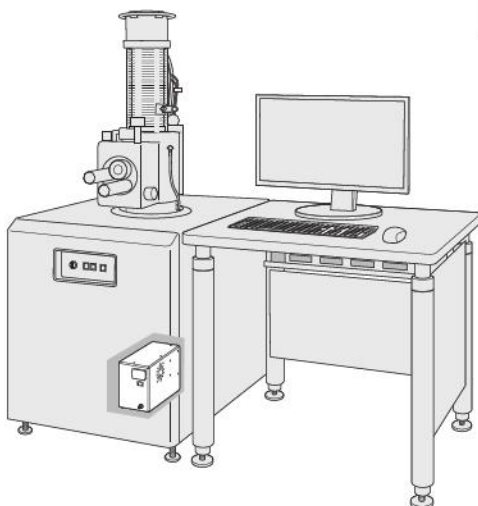
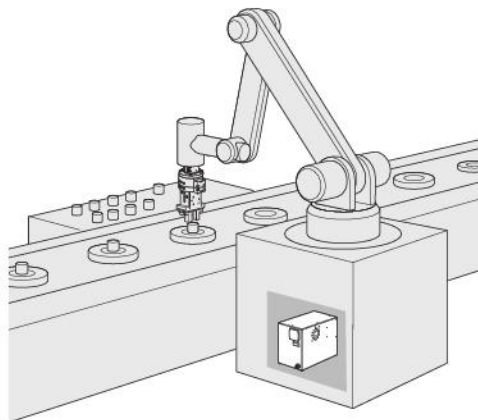



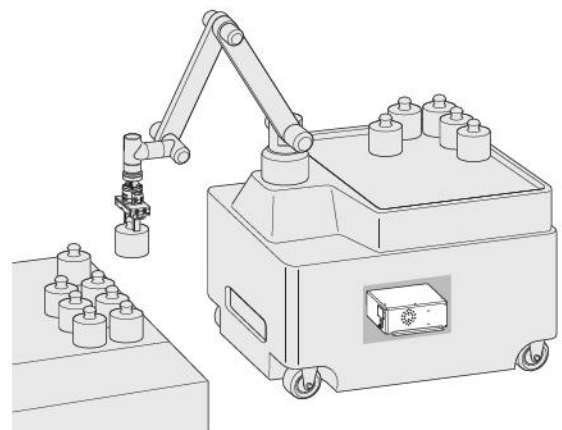

Built into the analyzer



Built into the transport robot

Before selecting and using products, please read all the Safety Precautions carefully to ensure proper product use. The Safety Precautions shown below are to help you use the product safely and correctly, and to prevent injury or damage to assets. Follow the Safety Precautions in ISO4414 (Pneumatic fluid power—General rules and safety requirements for systems and their components), JIS B 8370 (Pneumatic system regulations), and other safety regulations.

The directions are ranked according to degree of potential danger or damage: “DANGER”, “WARNING”, “CAUTION”, and “ATTENTION”.

 <b>DANGER</b>	Indicates situations that can be clearly predicted as dangerous. Death or serious injury may result if the situation is not avoided. It could also result in damage or destruction of assets.
 <b>WARNING</b>	Indicates situations that, while not immediately dangerous, could become dangerous. Death or serious injury may result if the situation is not avoided. It could also result in damage or destruction of assets.
 <b>CAUTION</b>	Indicates situations that, while not immediately dangerous, could become dangerous. Minor or semi-serious injury may result if the situation is not avoided. It could also result in damage or destruction of assets.
 <b>ATTENTION</b>	While there is no chance of injury, these points should be observed for appropriate use of the product.

- **This product was designed and manufactured for use in general industrial machinery.**
- In the selection and handling of the equipment, the system designer or other responsible person with fully adequate knowledge and experience should always read the Safety Precautions, Catalog, Owner’s Manual and other literature before commencing operation. Making mistakes in handling is dangerous.
- The customer is responsible for verifying and determining the compatibility of the product with the customer’s system.
- [After reading the Owner’s Manual, etc., always store them where they are easily available for reference to users of this product.
- If transferring or lending the product to another person, always attach the Owner’s Manual, etc., to the product where they are easily visible, to ensure that the new user can use the product safely and properly.
- The danger, warning, and caution items listed under these “Safety Precautions” do not cover all possible cases. Read the Catalog and Owner’s Manual carefully, and always keep safety first.

 **DANGER**

- Do not use the product for the purposes listed below:
  1. Medical equipment related to maintenance or management of human lives or bodies
  2. Mechanical devices or equipment designed for the purpose of moving or transporting people
  3. Critical safety components in mechanical devices  
This product has not been planned or designed for purposes that require advanced levels of safety. It could cause loss of human life.
- Do not use the product in locations with or near dangerous substances, such as flammable or ignitable substances. This product is not explosion-proof. It could ignite or burst into flames.
- The product must be installed in a flat and level place with enough space to work. Injury could result if the product overturns, falls, or operates abnormally.
- Persons using a pacemaker or other similar medical devices should maintain a distance of at least one meter [3.280 ft] away from the product. The magnetic field of the strong magnet built into the product may cause the pacemaker to malfunction.
- Never attempt to modify the product. Doing so creates the risk of injury, electric shock, fire, etc. due to abnormal operations.
- Never attempt inappropriate disassembly or assembly of the product relating to its basic configuration, or its performance or functions. Doing so creates the risk of injury, electric shock, fire, etc.
- Do not splash water on the product. Spraying the product with water, washing it, or using it in water could result in malfunction leading to injury, fire, etc.  
Do not perform any adjustment work on any internal or attached mechanisms (such as connecting or disconnecting wiring connectors, adjusting pressure switches, disconnecting tubes or sealed plugs, etc.) while the product is operating.  
Doing so could result in abnormal operation leading to injury.

 **WARNING**

- Do not use the product in excess of its specification range. Use in excess of its specification range could result in product breakdown, loss of function, or damage. It could also drastically reduce operating life.
- Before supplying electricity to start operating the product, be sure to do a safety check of the operating range. Unintentional supply of electricity may cause electric shock or injury due to contact with moving parts.
- Do not touch the terminals while the electric power is on. There is a possibility of electric shock and abnormal operation.
- If you ever notice abnormal noise or abnormally high vibration, immediately stop operation. Continued use under such conditions may result in damage to the product, abnormal operation due to damage, or runaway operation, etc.

- Do not throw the product into fire. The product could explode and/or release toxic gases.
- Do not sit on the product, place your feet on it, or place other objects on it. Doing so creates the risk of injury due to tripping or the product tipping over or falling, and erratic or runaway operation due to damage or breakage to the product.
- Before doing maintenance inspections, repairs, or replacement of any parts, always completely cut off all electric power, air, and vacuum pressure connections, and confirm that the pressure in the product and connected pipes is atmospheric pressure. In particular, be aware that residual pressure will still be in the product or air storage tank. Residual pressure inside the product may cause pressurized air to blow out unexpectedly and cause injury.
- Provide adequate shielding measures for use in the locations described below. Failure to install such measures creates the risk of abnormal operations, and could cause injury or damage to equipment.
  1. Locations where high electric currents or strong magnetic fields are generated
  2. Locations where static electricity or other types of noise are generated
  3. Locations where there is the possibility of radioactive contamination
- Use safety circuits or system designs to prevent damage to machinery or injury to personnel when the machine is shut down abnormally due to emergency stop or power failure.
- Correctly apply the rated voltage to the product. Applying the wrong voltage will make it impossible to obtain the specified functions, and creates the risk of damage to and burnout of the product.
- When the device has not been used for long periods (over 30 days), it is possible that the contacting parts may have become stuck leading to slow operation or sudden movements. Check for proper operation a minimum of once every 30 days.
- Do not locate the AC adapter (with power cable) near power lines carrying large currents, or in locations subject to strong magnetic fields or surges. It could result in unintended operation.
- Do not allow lead wires and other cords to become damaged. Allowing cords to be damaged, bent excessively, pulled, rolled up, placed under heavy objects, or squeezed between two objects may cause current leaks or defective continuity that can lead to fire, electric shock, or abnormal operation.
- Always check the catalog and other reference materials for correct product wiring and piping. Improper wiring or piping causes abnormal operation of the actuator, etc.
- Do not use the product near the ocean, in direct sunlight, near mercury vapor lamps, or near equipment that generates ozone. Deterioration of rubber parts caused by ozone may reduce performance and functions or stop functions.
- In initial operations after the equipment has been idle for 48 hours or more, or has been in storage, there is a possibility that contacting parts may stick, resulting in equipment operation delays or sudden movements. For these initial operations, always run a test operation before use to check that operating performance is normal.

- Because Koganei products may be used under a wide variety of conditions, decisions concerning conformance with a particular system should be made upon the careful evaluation by the person in charge of system design. Assurances concerning expected system performance and safety are the responsibility of the designer who decides system conformity. Be sure to use the latest catalogs and technical materials to study and evaluate specification details, to consider the possibility of machine breakdown, and to configure a system that ensures fail-safe safety and reliability.
- Do not use the product in locations subject to direct sunlight (ultraviolet radiation), in locations with dust, salt, or iron particles, or in locations with media and/or ambient atmosphere that include organic solvents, phosphate ester type hydraulic oil, sulfur dioxide gas, chlorine gas, acids, etc. Such uses could lead to loss of functions within a short period, sudden degradation in performance, or reduced operating life.

 **CAUTION**

- When installing the product, leave room for adequate working space around it. Failure to do so will make it more difficult to conduct daily inspections or maintenance, which could eventually lead to system shutdown or damage to the product.
- Do not use the product in environments where there is corrosive gas, flammable gas, flammable liquid, etc. There is a risk that the formation of rust could cause strength to deteriorate, or the motor to catch fire or explode.
- Do not scratch, dent, or deform the product by climbing on the product, using it as a step, or placing objects on top of it. Doing so could damage or break the product, resulting in operation shutdown or degraded performance.
- When transporting or mounting a heavy product, firmly support the product using a lift or support, or use multiple people to ensure personal safety.
- Always be sure to post a "Work in Progress" sign during installation, adjustment, or other operations, to avoid unintended supply of electric power, etc. Turning on the power unexpectedly could cause injury due to electric shock or abrupt operations.
- Do not bring any magnetic media within 1 meter [3.280 ft] of the energized product. Doing so creates the risk of damage to data on the magnetic media due to magnetism.
- Do not block the ventilation holes on the sides of the product. Doing so creates the risk of injury or damage to the equipment.
- When carrying the product, be sure to stop operation and take care not to drop it.
- The compressor does not have a pressure regulator, or an internal filter or other filtration device. An air filter and regulator must be installed to use the product.
- Always attach a filter to the suction port of the vacuum pump. Without a filter, dust, dirt, etc. will enter the pump, causing it to stop functioning after a short period of time, rapid performance degradation, and a reduced operating life.
- Air leakage from the product is not zero. Designs should take into consideration the capacity and retention time required to retain pressure (including vacuum).
- The targeted vacuum pressure may not be reached at high elevations or due to atmospheric pressure fluctuations. In such cases, change the unload pressure by operating the pressure switch.
- Turn off the power before wiring the I/O and communication cables.
- Avoid locations subject to strong vibration and/or impact.

 **ATTENTION**

- When considering the possibility of using this product in situations or environments not specifically noted in the Catalog or Instruction Manual, or in applications where safety is an important requirement, such as in an aircraft facility, combustion equipment, leisure equipment, safety equipment and other places where human life or assets may be greatly affected, use the product sufficiently within its specified ratings and performance and take adequate safety precautions, such as the use of fail-safes. Be sure to consult us about such applications.
- Always check the catalog and other reference materials for correct product wiring and piping.
- When handling the product, wear protective gloves, safety glasses, safety shoes, etc., as required to maintain safety.

- When the product can no longer be used, or is no longer necessary, dispose of it appropriately as industrial waste.
- Pneumatic equipment can exhibit degraded performance and function over its operating life. Always conduct daily inspections of the pneumatic equipment, and confirm that all requisite system functions are satisfactory, to prevent accidents from happening.
- Ambient temperature must be between 5 to 40°C [41 to 104°F]. When incorporating the product into some other equipment, be especially careful that the ambient temperature is 0 to 40°C [32 to 104°F].
- Use rubber feet or the tapped holes on the bottom of the product or L-brackets to secure the product in place. There is a possibility of increased product noise, product movement, internal malfunction, or abnormal operation.
- For inquiries about the product, consult your nearest Koganei sales office or Koganei Overseas Department. The addresses and telephone numbers are shown on the back cover of this catalog.

 **Other**

- Always observe the following items.
  1. When using this product in a system, use only genuine Koganei parts or equivalent (recommended) parts. When conducting maintenance and repairs, always use genuine Koganei parts or compatible parts (recommended parts). Always observe the prescribed methods and procedures.
  2. Never attempt unauthorized disassembly or assembly of the product relating to its basic construction, its performance, or its functions.

Koganei shall not be held responsible for any problems that occur as a result of these items not being properly observed.

**Warranty and General Disclaimer**

1. Warranty Period
 

Koganei warrants this product for a period of no more than 1 year from delivery.

\* However, some products have a 2-year warranty; contact your nearest Koganei sales office or the Koganei Technical Service Center for details.
2. Scope of Warranty and General Disclaimer
  - (1) When a product purchased from Koganei or from an authorized Koganei distributor malfunctions during the warranty period in a way that is found to be attributable to Koganei responsibility, Koganei will repair or replace the product free of charge. Even if a product is still within the warranty period, its durability is determined by its operation cycles and other factors. Contact your nearest Koganei sales office or the Koganei overseas department for details.
  - (2) The Koganei product warranty covers only the product itself. Therefore, Koganei is not responsible for incidental losses (repair of the product, various expenses required for replacement, etc.) caused by breakdown, loss of function, or loss of performance of Koganei products.
  - (3) Koganei shall not be held responsible for any losses or for any damage to other machinery caused by breakdown, loss of function, or loss of performance of Koganei products.
  - (4) Koganei shall not be held responsible for any losses due to use or storage of the product in a way that is outside of the product specifications prescribed in Koganei catalogs and the instruction manual, and/or due to actions that violate the mounting, installation, adjustment, maintenance and other safety precautions.
  - (5) Koganei shall not be held responsible for any losses caused by breakdown of the product due to factors outside the responsibility of Koganei, including but not limited to fire, natural disaster, the actions of third parties, and intentional actions or errors by you.

# Handling Instructions and Precautions

## Installation

1. The product should be installed on a level and flat surface by one of the following methods.

### [Installation Method]

- ① **Bottom mount:** Use the M3 depth 4 mm [0.157 in.] on the bottom of the product to secure it. (Tightening torque: 0.63 N·m [5.576 in·lbf])
- ② **Rubber feet (-G):** If you have selected rubber feet, install the product on a flat firm surface to prevent wobbling.
- ③ **L-bracket (-L):** If you have selected L-brackets, use the provided L-brackets to secure the product. (Tightening torque for L-bracket to product: 0.63 N·m [5.576 in·lbf])

Note 1: Install the product so its bottom faces down.

2: In order to fix the product, use the bolts attached to the product, or use bolts that are within the thread depth. Usage of long bolts will result in damage to internal components.

2. Ensure the installation surface is adequate.
3. The sides of the product with ventilation holes must be at least 30 mm [1.181 in.] away from walls, and care must be taken not to block the ventilation holes. If ventilation space is not provided, internal temperatures will rise due to lack of ventilation, resulting in a significant decrease in life expectancy.

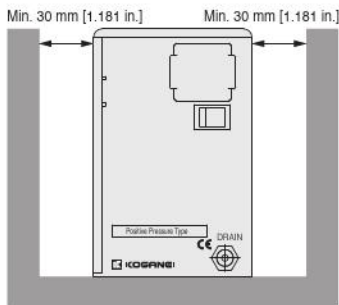

4. Positive pressure types (compressors) are not equipped with internal filters or other filtration devices or pressure regulating devices.

Also, since condensate (moisture) is generated, a moisture separator, filter, and regulator should be installed when compressed air is used.

\* Recommended models: Water separator **IBCY30**, filter regulator **FRZB30**.

\* Install in the order of compressor, water separator, filter and regulator.

5. Be sure to install a filter on the suction port side of the negative pressure type (vacuum pump). Without a filter, dust, dirt, etc. will enter the pump, causing it to stop functioning after a short period of time, rapid performance degradation, and a reduced operating life.

\* Recommended model: Filter **VLF050**

6. Be sure to install a mechanism for exhausting residual pressure on the OUT (Vacuum) side of the compressor or vacuum pump.

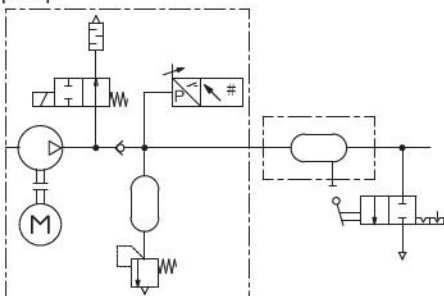

## Wiring

1. Wiring for power supply

**[When using DC power supply]**

• Use the following power cables.

Model: SMPKP-D1L (1 m [3.280 ft])

Model: SMPKP-D3L (3 m [9.840 ft])

• Connect the loose wires to a DC24V (22 to 27V) power supply.

Pay particular attention to the wire polarity to prevent mis-wiring when connecting wires.

<Power Cable Signal Table>

No.	Signal Name	Line Color
1	24V	White
2	0V	Black

• Insert the plug all the way into the power input jack of the product. Connections that are not secure may cause electric shock or electric leakage.

**[When using AC power supply]**

Use the following AC adaptors.

Model: SMPKP-AD

• Insert the plug all the way into the power input jack of the product. Connections that are not secure may cause electric shock or electric leakage.

• Insert the plug all the way into the power input jack and then connect to an AC 100V power source (outlet).

2. Installing the ground wire

Install a ground wire for noise resistance.

(M3 small screw with washer, tightening torque: 0.63 N·m [5.576 in·lbf], and ground wire should be provided by user.)

\*AWG16 to 18, 2 m [6.560 ft] or less is recommended for the ground wire.

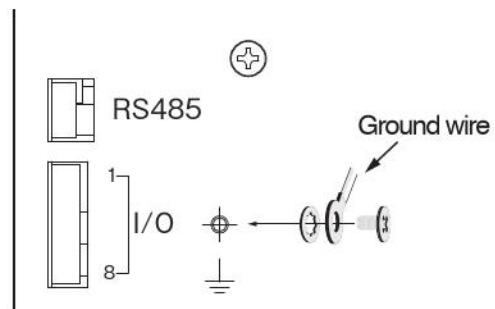

# Handling Instructions and Precautions

## 3. I/O Cable Installation

Customers who use the I/O function should insert the I/O cable as follows.

Note: Please prepare the I/O cable yourself.

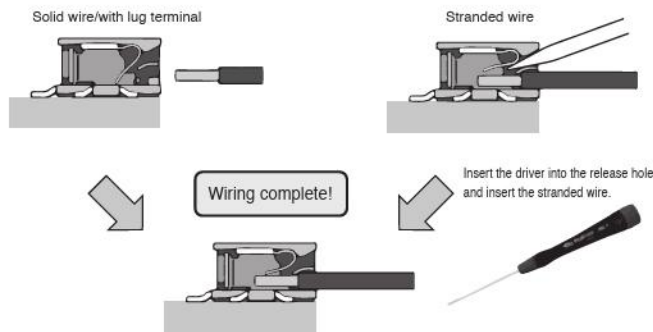

### Compatible wire

Single wire	0.14 to 0.5 mm <sup>2</sup> [0.0002 to 0.0007 in <sup>2</sup> ]
Stranded wire	0.2 to 0.5 mm <sup>2</sup> [0.0003 to 0.0007 in <sup>2</sup> ]
Rod terminal	0.25 to 0.34 mm <sup>2</sup> [0.0003 to 0.0005 in <sup>2</sup> ]
AWG	26 to 20 [0.039 to 0.787]

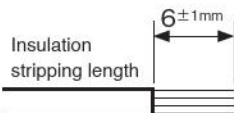

Note: Please do not solder the spare wire. It may cause contact failure.

### I/O Connector Signal Table

NO.	Signal Name	Input & Output	Description
1	GND	—	Power Supply
2	24V	—	Power Supply
3	RESTART	Input	Start Signal
4	STOP	Input	Stop Signal
5	N.C.	—	Not Connected
6	PRESSURE	Output	Threshold Reached Output
7	ALM	Output	Alarm Output
8	N.C.	—	Not Connected

※The I/O connectors of the product are No.1 on the top and No.8 on the bottom.

### Wiring Example

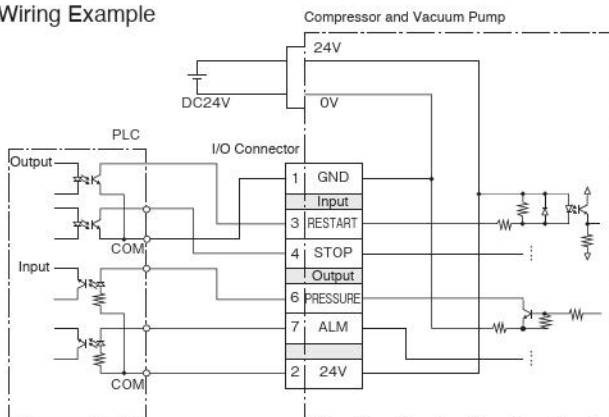

※For details regarding I/O, please refer to the instruction manual.

## Piping

1. The connection ports of compressors and vacuum pumps are quick fittings for 6 mm [0.236 in.] outside diameter tubing.

Note 1. Use tubing with an exterior that is not damaged. If tubing becomes damaged after repeated use, cut off the damaged portion.

2. Do not allow tubing to become severely bent or twisted near the connection to a fitting. Such a condition creates the risk of air leakage. The table below shows minimum radius guidelines for nylon and urethane tubing.

Tube Size	Minimum Bending Radius	
	Nylon Tube	Urethane Tube
φ 6 [0.236]	30 [1.181]	15 [0.591]

3. Do not use extremely soft tubing, which causes a severe drop in pull-out strength.

4. Before removing any tubes, always turn off the air supply. Also, be sure to confirm that the air inside the pipes is completely vented before starting.

### 2. Attaching and detaching tubes

※Before attaching or detaching the tube, be sure to turn off the power switch and bleed air using the residual pressure exhaust mechanism.

#### Precautions for attaching tubes

- Confirm that the cut surface of the tube is cut straight across, that the outer surface of the tube is not damaged, and that the tube has not become oval shaped.
- When connecting tubes, if you do not insert the tube all the way to the tube end, it may result in leaks.

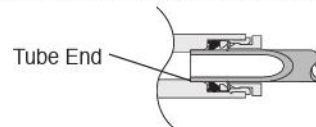

- After installing the tube, pull on it to check that it does not come off.

#### Precautions for opening tubes

- Before opening tubing, be sure to confirm that the pressure inside the compressor is zero.
- Uniformly press the release ring inwards as far as it goes and then pull out the tubing. If you do not fully press in on the release ring, the tube may not come out, or the tubing may become scratched causing debris to be left inside the fitting.

#### How to attach and detach tubes

##### 1 Attaching tubes

Quick fittings are equipped with lock claws that hold tubes in place when they have pushed all the way to the end, and with an elastic sleeve for sealing the periphery around the tubes.

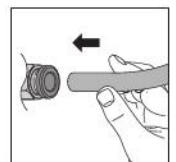

##### 2 Removing tubes

When removing a tube, pressing the release ring opens the lock claw and the tube can be pulled out.



Be sure to stop the air before removing tubes.

### 3. Sealing the condensate port

Insert a sealing plug or a push-button valve (φ4 [0.157] tubes provided by customer) into the condensate port. (A sealing plug is inserted at time of shipment.) If the condensate port is not sealed, the pressure will not rise.

\* Negative pressure types (vacuum pumps) do not have a condensate port.

## Handling Instructions and Precautions

### Operation

- Before operation, make sure that all piping and wiring has been done correctly.
- For the positive pressure type (compressor), when the power switch is turned ON, the pressure switch comes on and the pressure display value rises. When the pressure in the compressor reaches 0.6 MPa [87 psi], it automatically stops (unloads). When compressed air is consumed and the pressure in the compressor drops to 0.50 MPa [73 psi], it automatically restarts operating (loads).

Note: When compressed air consumption exceeds the compressor's capacity, the compressor operates continuously.

\*The setting can be changed by setting the pressure switch. See the instruction manual for setting details (unload pressure: Hi-1, load pressure: Lo-1)

- For the negative pressure type (vacuum pump), when the power switch is turned ON, the pressure switch comes on and the pressure display value falls. When the pressure in the vacuum pump reaches 85 kPa [25.109 inHg], it automatically stops (unloads). As air is sucked in, the pressure in the vacuum pump increases, and when it reaches 60 kPa [17.724 inHg], the pump automatically restarts operating (loading).

Note: The vacuum pump operates continuously when the air suction volume exceeds the capacity of the vacuum pump.

\* The above load and unload pressures are initial values. The setting can be changed by setting the pressure switch. See the instruction manual for setting details (unload pressure: Hi-1, load pressure: Lo-1)

\* The targeted vacuum pressure may not be reached at high elevations or due to atmospheric pressure fluctuations. In such cases, change the unload pressure by operating the pressure switch.

- When the power switch is turned OFF, the device stops operating.

Note: Be careful, because even after operation has stopped, the compressor and vacuum pump will still have residual pressure in the internal tank, piping, etc.

- If a large amount of compressed air or vacuum is temporarily required, connecting an external air tank (Koganei type: DPT) may be effective.

● An example of stable use of the air hand

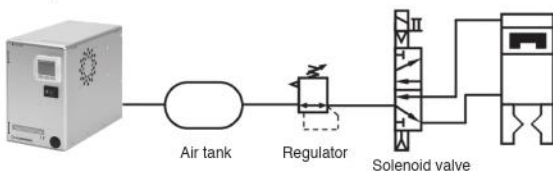

\* By attaching an air tank, pressure fluctuations will be smoothed. Please select whether or not to use a tank and its capacity according to your usage.

- If a system abnormality occurs, an alarm will be generated and the drive unit will stop. At that time, the pressure gauge display will blink. However, the fan will not stop in case of a temperature abnormality. If the abnormality is resolved by turning the power OFF/ON, the alarm state will be released.

\*If an alarm occurs, please remove the cause before restarting. For details, please refer to the instruction manual.

- By using I/O, the following additional functions can be utilized.

① PRESSURE output: Output when the pressure exceeds the threshold (0.4MPa [58 psi])

\*This serves as a standard for whether the air equipment can operate normally.

\* The threshold values mentioned above are initial values. They can be changed according to the settings of the pressure switch. Please refer to the instruction manual for details on the settings. (Threshold pressure: P-2)

② ALM output: Output when an alarm occurs

\* Please refer to the instruction manual for details.

③ STOP Input: Stop motor and fan operation at any time

\*This is effective when you want to temporarily stop the product's vibration. However, since it does not operate even below the load pressure, the pressure will not increase.

④ RESTART Input: Restart operation at any time

\*Cancels the STOP state and alarm state, and returns to the normal state.

\*If an alarm occurs, please eliminate the cause and restart.

- The following additional functions can be used when using communication.

① I/O functions can also be used via communication

② Error history reading

③ Error history initialization

④ Cumulative operating time, motor operating time reading

⑤ Version reading

\*We also provide free support software.

### Draining condensate

(Positive pressure type (compressor) only) Condensate collects in the piping inside the compressor. So, you need to drain the condensate periodically.

- When equipped with a sealing plug (condensate port specification: blank) A sealing plug (model: UP4 (1 pc)) is inserted into the condensate port. The condensate can be drained by taking the sealing plug out of the condensate port.

Before removing the sealing plug, be sure to relieve the pressure and check that the secondary side pressure is at atmospheric pressure. Be sure to put the sealing plug back in after the condensate has been drained.

- When equipped with a push-button type valve (condensate port specifications: -V)

An assembly of a push-button valve (model: 2P (1 pc)) and fittings (model: TS4-M5M (2 pcs)) is provided.

Remove the sealing plug inserted in the drain port and insert the 4 [0.157 in.] outside diameter tube (provided by the user) to the depth of the drain port and push-button valve.

You can drain the condensate by pushing the button on the push-button valve.

Note that if the button is pressed when the secondary side is not at atmospheric pressure, air and condensate will come out vigorously and the pressure on the secondary side will drop.

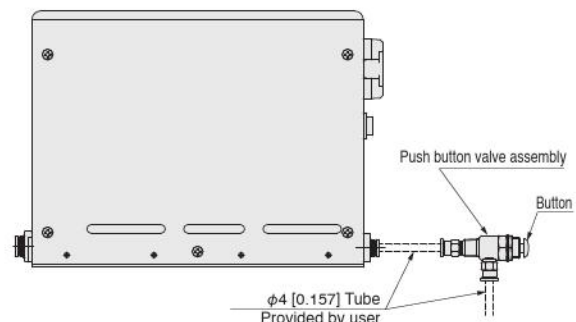

\*This product is an oil-free compressor and does not use lubricating oil, but impurities such as moisture, oil, dust, and wear debris from the air will be contained in the drain.

\*Negative pressure types (vacuum pumps) do not generate condensate, so they do not have a condensate port.

# SmartMini Compressor



## Specification

### Positive pressure type (compressor)

Item	Model	SMPP4Y	SMPP4T
Configuration Type		Horizontal	Vertical
Maximum Pressure	MPa [psi]	0.6 [87]	
Exhaust Flow Rate	(at 0.5 MPa [73 psi]) L/min.(ANR) [ft3/min.(SCFM)]	4.0 [0.141]	
Control Pressure <sup>Note 1</sup> (Unloading / Loading)	MPa [psi]	0.6 [87] / 0.5 [73] <sup>Note 2</sup>	
Noise <sup>Note 3</sup>	dB	50	
Pipe Port		Quick fitting for tubes with outside diameter $\phi$ 6 [0.236]	
Mass	kg [lb]	2.4 [5.292]	
Ambient Temperature Range	°C [°F]	5 to 40 [41 to 104] (non-condensation, non-freezing)	
Input Voltage	V	DC24 (switching power supply can be used) <sup>Note 4</sup>	
Rated Current	A	2.7 (instantaneous 5)	
Power Supply Specifications		AC adapter/DC power supply cable	

Note 1: When the internal pressure reaches the unload pressure, the compressor stops temporarily and restarts when the pressure drops to the load pressure (restart pressure).

2: Initial value. Settings can be changed by user.

3: Values measured under Koganei measurement conditions. Measured at a distance of 1 m [3.280 ft] from the front (installed with the pressure indicator monitor facing front).

The value may be greater than the stated value depending on operating and installation conditions.

4: Use an input voltage in the range of 22V to 27V.

### Negative pressure type (vacuum pump)

Item	Model	SMPV4Y	SMPV4T
Configuration Type		Horizontal	Vertical
Arrival vacuum pressure <sup>Note 1</sup>	kPa [inHg]	- 85 [ - 25.109]	
Maximum suction flow rate	L/min.(ANR) [ft3/min.(SCFM)]	10 [0.353]	
Control Pressure <sup>Note 2</sup> (Unloading / Loading)	kPa [inHg]	- 85 [ - 25.109] / - 60 [ - 17.724] <sup>Note 3</sup>	
Noise <sup>Note 4</sup>	dB	50	
Pipe Port		Quick fitting for tubes with outside diameter $\phi$ 6 [0.236]	
Mass	kg [lb]	2.4 [5.292]	
Ambient Temperature Range	°C [°F]	5 to 40 [41 to 104] (non-condensation, non-freezing)	
Input Voltage	V	DC24 (switching power supply can be used) <sup>Note 5</sup>	
Rated Current	A	2.7 (instantaneous 5)	
Power Supply Specifications		AC adapter/DC power supply cable	

Note 1: Standard atmospheric pressure (1013 hPa)

2: When the internal pressure reaches the unload pressure, the vacuum pump stops temporarily and restarts when the pressure rises to the load pressure (restart pressure).

3: Initial value. Settings can be changed by user.

4: Values measured under Koganei measurement conditions. Measured at a distance of 1 m [3.280 ft] from the front (installed with the pressure indicator monitor facing front).

The value may be greater than the stated value depending on operating and installation conditions.

5: Use an input voltage in the range of 22V to 27V.

# Order Codes

## Main Body Type

### Positive Pressure Type (Compressor)

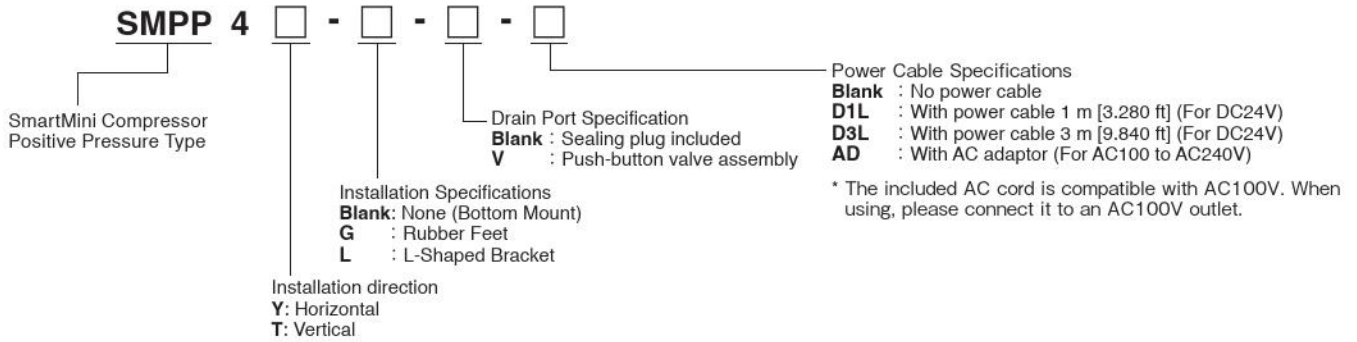

### Negative Pressure Type (Vacuum Pump)

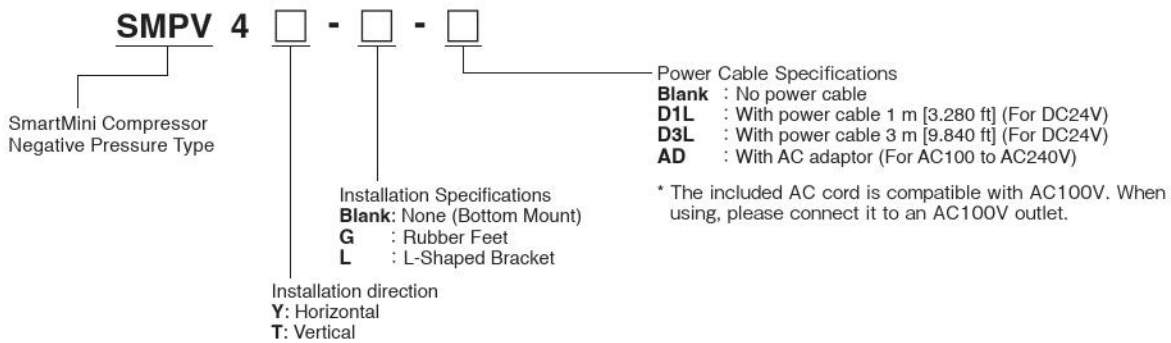

## Additional Parts

### Power Cable

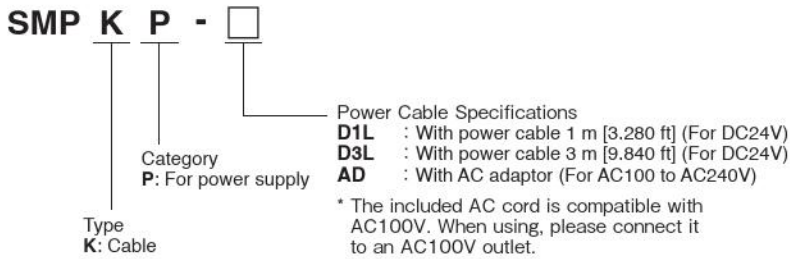

### Communication Cable (USB-RS485 Converter)

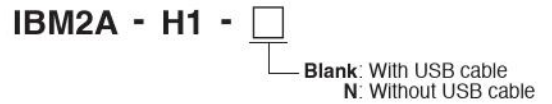

\*Please use it when communicating with a computer or similar device.

(For RS485 communication, bare wire)

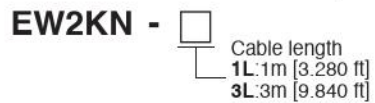

\*Please use this when communicating with PLCs, etc.

## Flow Characteristics

### Positive Pressure Type SMPP4□

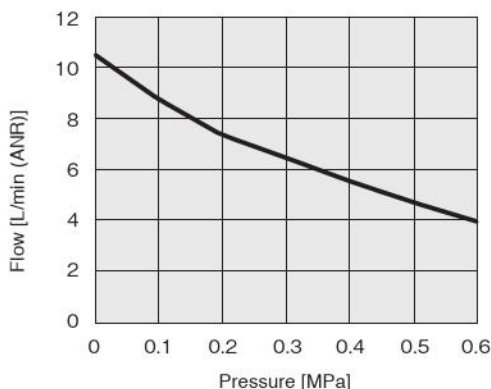

※Based on our initial performance tests

### Negative Pressure Type SMPV4□

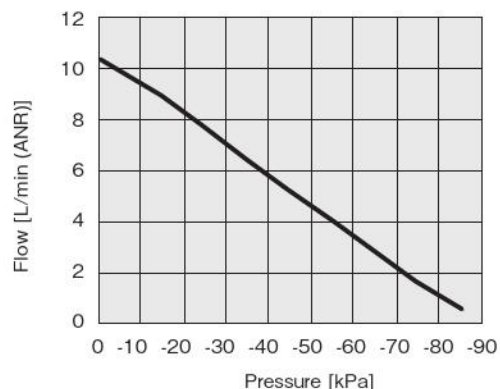

※Based on our initial performance tests

# Dimension Diagram (mm [in.])

## SMPP4Y SMPV4Y (Horizontal type)

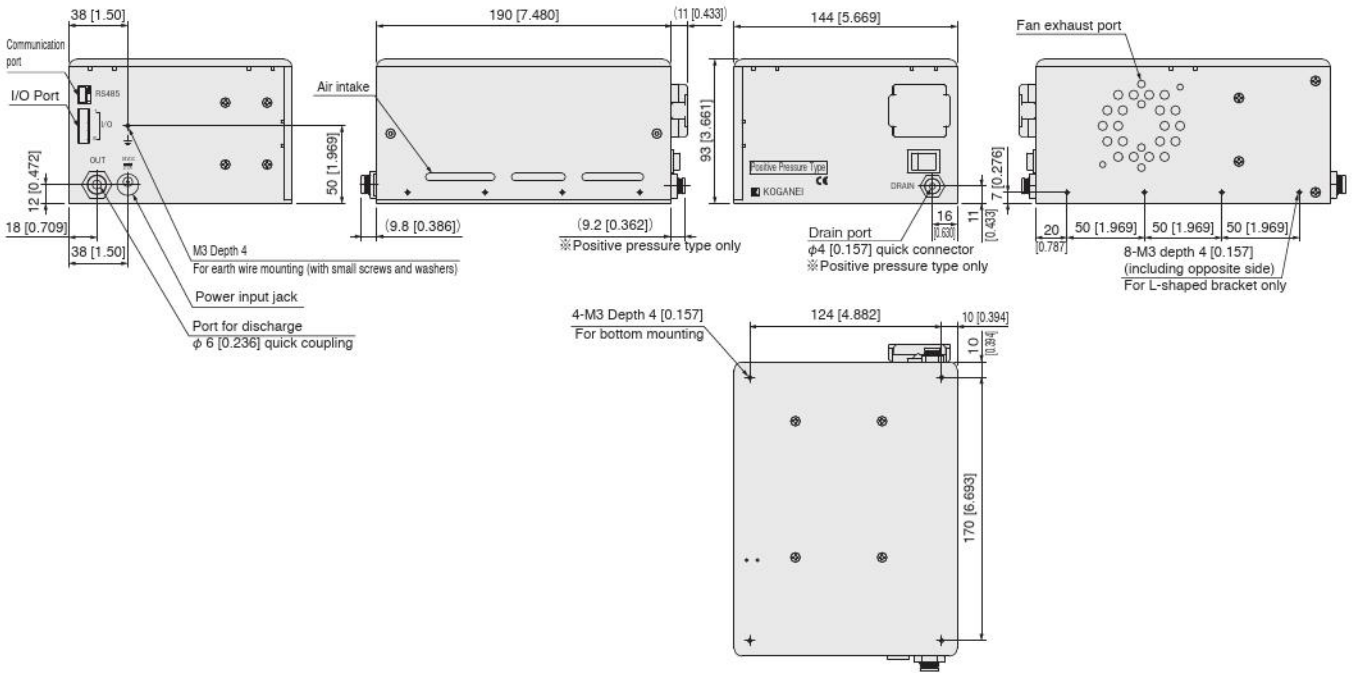

### Installation Specifications

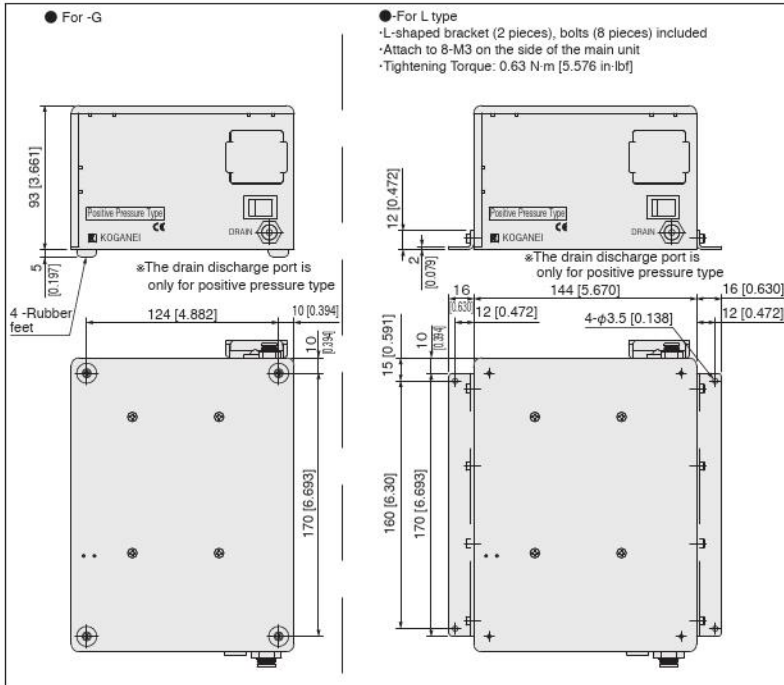

### Drain Port Specifications (Positive Pressure Type Only)

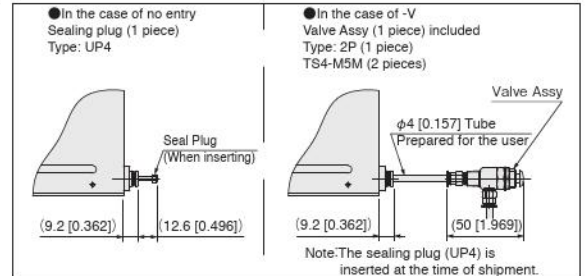

### Appearance of Negative Pressure Type

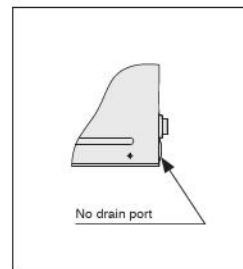

# SMPP4T SMPV4T (Vertical type)

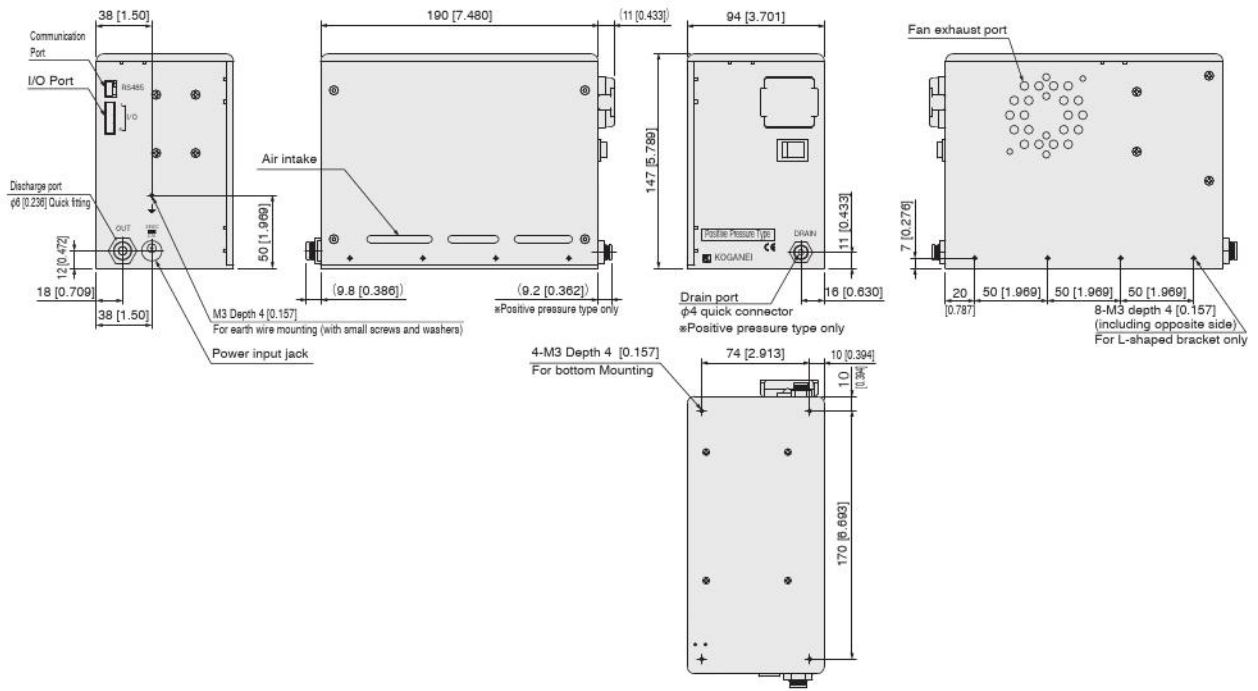

## Installation Specifications

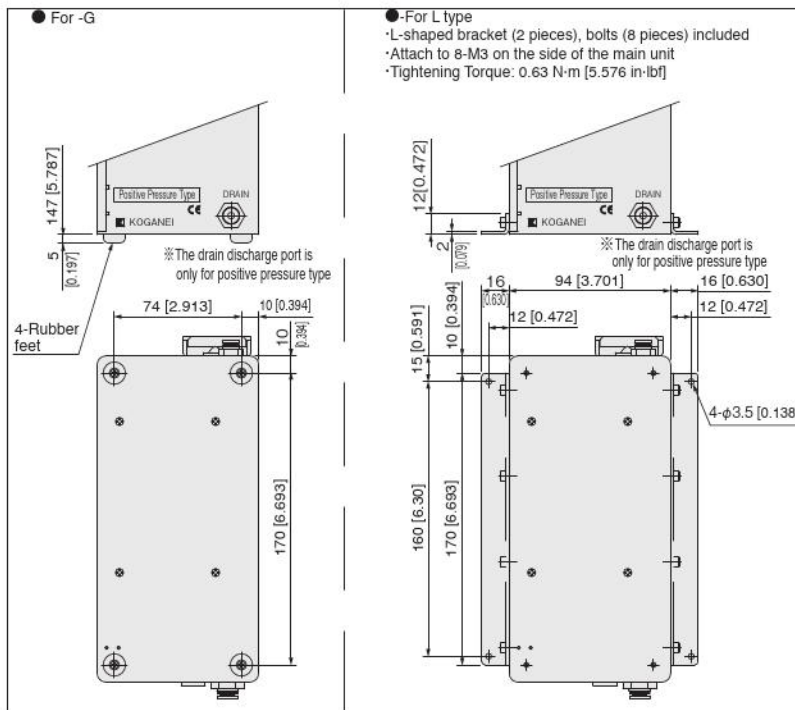

## Drain Port Specifications (Positive Pressure Type Only)

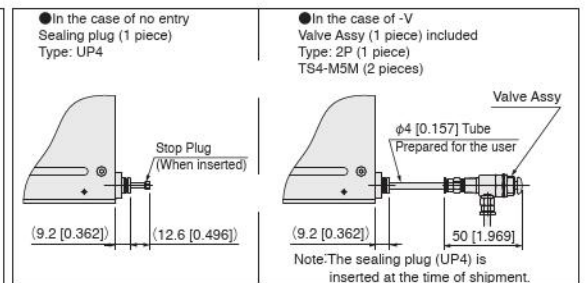

## Appearance of Negative Pressure Type

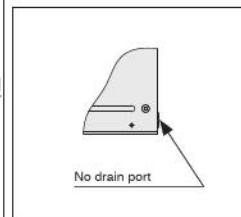

## Dimension Diagram (mm [in.])

### ● SMPKP-D□

Power cable (for DC24V)

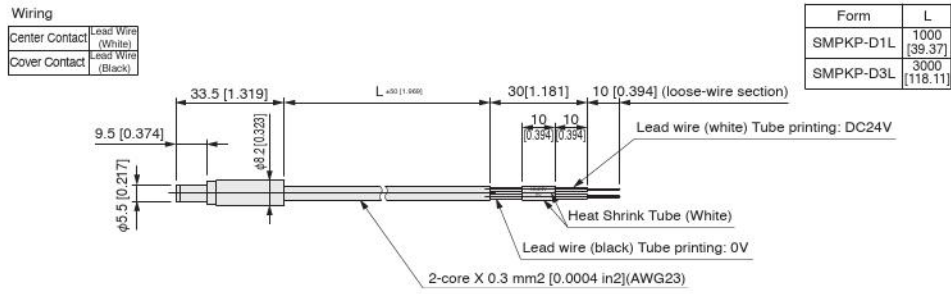

### ● SMPKP-AD

AC adapter (for AC100~240V)

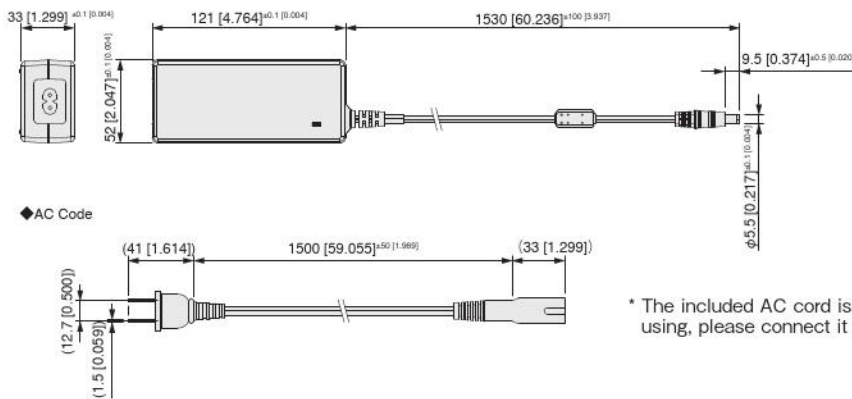

### ● IBM2A-H1-□

Communication Cable (USB-RS485 Converter)

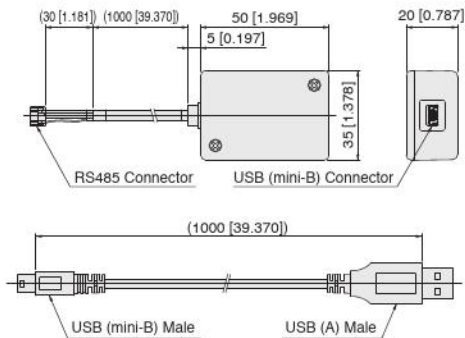

### ● EW2KN-□

Communication Cable (For RS485 Communication, Stranded Wire)

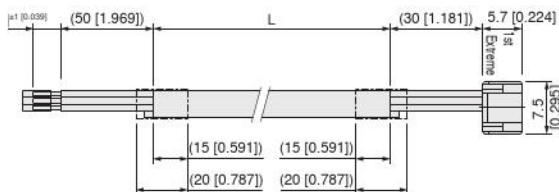

Model	L
EW2KN-1L	1000 [39.37]
EW2KN-3L	3000 [118.11]

Connector terminal arrangement (controller lower)

1	NO.	Name	Color
2	1	A	White
3	2	B	Peach
4	3	GND	Yellow
5	4		
	5		



# Limited Warranty

KOGANEI CORP. warrants its products to be free from defects in material and workmanship subject to the following provisions.

**Warranty Period** The warranty period is 180 days from the date of delivery.

**Koganei Responsibility** If a defect in material or workmanship is found during the warranty period, KOGANEI CORP. will replace any part proved defective under normal use free of charge and will provide the service necessary to replace such a part.

**Limitations**

- This warranty is in lieu of all other warranties, expressed or implied, and is limited to the original cost of the product and shall not include any transportation fee, the cost of installation or any liability for direct, indirect or consequential damage or delay resulting from the defects.

- KOGANEI CORP. shall in no way be liable or responsible for injuries or damage to persons or property arising out of the use or operation of the manufacturer's product.

- This warranty shall be void if the engineered safety devices are removed, made inoperative or not periodically checked for proper functioning.

- Any operation beyond the rated capacity, any improper use or application, or any improper installation of the product, or any substitution upon it with parts not furnished or approved by KOGANEI CORP., shall void this warranty.

- This warranty covers only such items supplied by KOGANEI CORP. The products of other manufacturers are covered only by such warranties made by those original manufacturers, even though such items may have been included as the components.

The specifications are subject to change without notice.

URL <http://www.koganei.co.jp>

E-mail: [overseas@koganei.co.jp](mailto:overseas@koganei.co.jp)



## KOGANEI CORPORATION

### OVERSEAS DEPARTMENT

Takanawa Office, 3F, PMO Takanawa Gateway, 2-19-17, Takanawa, Minato-Ku, Tokyo, 108-0074, Japan

Tel: (+81)-3-6721-7478 Fax: (+81)-3-5424-1021

### KOGANEI INTERNATIONAL AMERICA, INC.

48860 Milmont Drive, suite 108C, Fremont, California 94538

Tel : 1-510-744-1626 Fax : 1-510-744-1676

### SHANGHAI KOGANEI INTERNATIONAL TRADING CORPORATION

RM2601-2602, Tongda Venture Building No.1, Lane 600, Tianshan Road, Shanghai, China (200051)

Tel: 86-21-6145-7313 Fax: 86-21-6145-7323

### TAIWAN KOGANEI TRADING CO.,LTD

Rm. 2, 16F., No88, Sec. 2, Zhongxiao E. Rd., Zhongzheng Dist., Taipei City 100, Taiwan(ROC)

Tel: 886-2-2393-2717 Fax: 886-2-2393-2719

### KOGANEI KOREA CO.,LTD

A-3001, Heungdeok IT Valley Bldg., Heungdeok 1-ro, 13, Giheung-gu, Yongin-si, Gyeonggi-do, 446-908, KOREA

Tel: 82-31-246-0414 Fax: 82-31-246-0415

### KOGANEI (THAILAND) CO.,LTD

555, Rasa One Building A, 11th Fl., Unit 1107 and 1108, Phaholyothin Road, Chatuchak, Chatuchak, Bangkok 10900

Tel: +66 (0) 2513-1228-31 Fax: +66 (0) 2513-1232

### KOGANEI AUTOMATION (MALAYSIA) SDN. BHD.

Suite 29-2, Level 29, Menara 1MK, No.1, Jalan Kiara, Mont Kiara 50480, Kuala Lumpur, Malaysia

Tel: 60-12-537-7086

### KOGANEI ASIA PTE. LTD.

69 Ubi Road 1, #05-18 Oxley Bizhub Singapore 408731

Tel: 65-6293-4512 Fax: 65-6293-4513