



Regulators with Quick Fittings



Push Lock Knob for Easy Pressure Setting and Adjusting

- Increased Flow Rate by 1.3x, Reduced Pressure Fluctuation Margin
- Relief Mechanism Equipped
- Available with Pressure Gauge



Regulators with Quick Fittings

- Push Lock Type Elbow (With or Without Pressure Gauge)
- Push Lock Type Union (With or Without Pressure Gauge)

- Push lock knob **allows one handed** pressure setting and adjusting operations.
- Push lock knob is excellent for **preventing lock nuts** being loosened by **mechanical vibrations**.



- New configuration provides **nearly 1.3x flow rate** over existing products. **Greater reduction in pressure fluctuation margin** makes steady pressure supply possible.

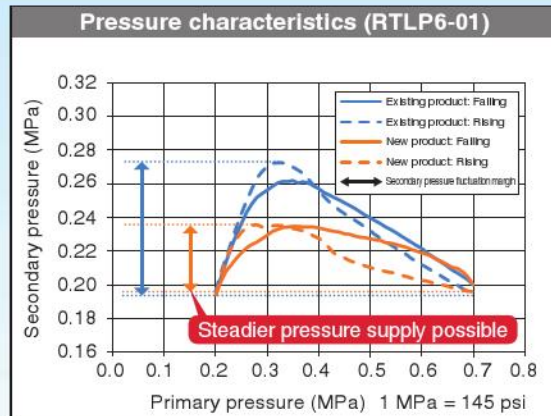

Note: After setting primary pressure: 0.7 MPa [102 psi] and secondary pressure: 0.2 MPa [29 psi], fluctuation of primary pressure: 0.7 MPa [102 psi] → 0.2 MPa [29 psi] → 0.7 MPa [102 psi].

- **Internal check mechanism**
Install the product between solenoid valves and actuators to be used as a regulator with a built-in check mechanism.

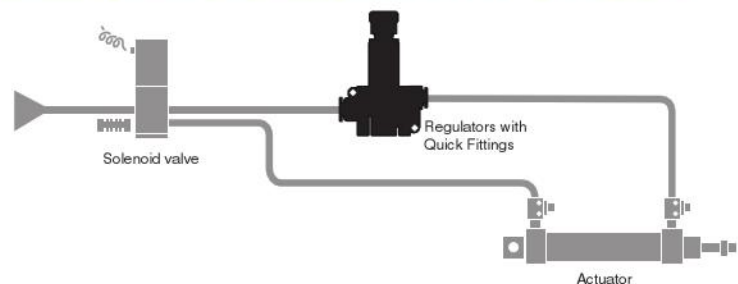

- Equipped with **relief mechanism** which is useful for adjusting devices.

- **Pressure gauge** added to lineup. Pressure gauge can be rotated to any orientation.



Elbow with pressure gauge



Union with pressure gauge



Symbol

- Without Pressure Gauge ● With Pressure Gauge

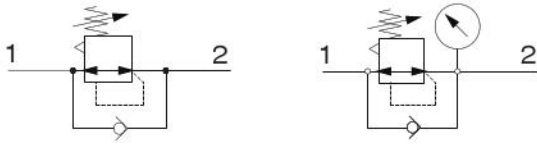

Specifications

Item	Model	RTLP□-□-□	RTUP□-□-□
		Elbow	Union
Medium	Air (Cannot be used for vacuum)		
Operating pressure range	0 to 1.0 MPa [0 to 145 psi]		
Pressure range settings	0.1 to 0.8 MPa [15 to 116 psi]		
Pressure range display	0 to 0.8 MPa [0 to 116 psi]		
Accuracy (pressure gauge)	±5% (full scale)		
Operating temperature range	0 to 60°C [32 to 140°F] (non-freezing)		
Recommended tubes	Nylon or urethane tubes		
Sales unit	1 pc.		

Internal Configuration and Materials of Major Parts

- For Elbow (RTLP□-□)

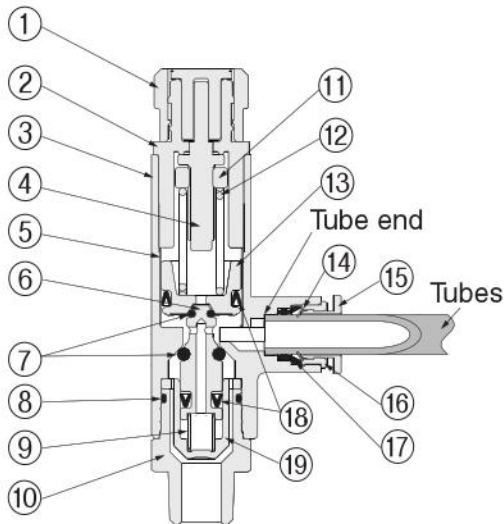

No.	Name	Material
①	Pressure adjustment knob	POM
②	Bonnet	POM
③	Plastic body	PBT
④	Pressure adjustment screw	Brass, electroless nickel plated
⑤	Liner	Brass, electroless nickel plated
⑥	Valve element	POM
⑦	O-ring	HNBR
⑧	O-ring	NBR
⑨	Valve element spring	Stainless steel
⑩	Metal body ^{Note}	Brass, electroless nickel plated
⑪	Pressure adjustment nut	SPCC, electro-galvanized
⑫	Pressure adjustment spring	Piano wire
⑬	Piston	POM
⑭	Lock hook	Stainless steel
⑮	Release ring	POM
⑯	Guide ring	Brass, electroless nickel plated
⑰	Elastic sleeve	NBR
⑱	V packing	NBR
⑲	Valve element guide	POM

Note: Tapered threads for pipes are Sealock processed, and meter threads have gaskets (SUS304+NBR).

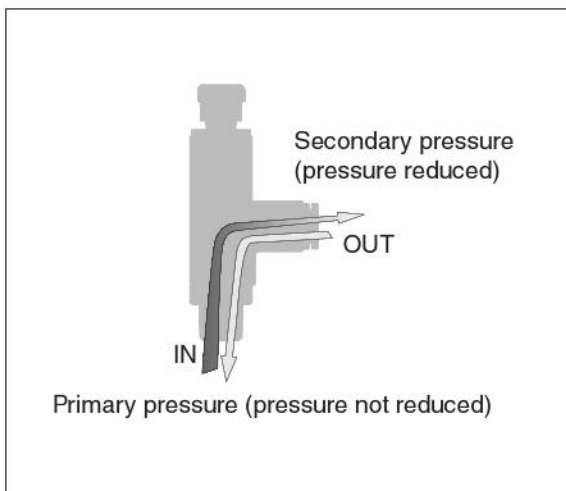

Order codes

● Elbow

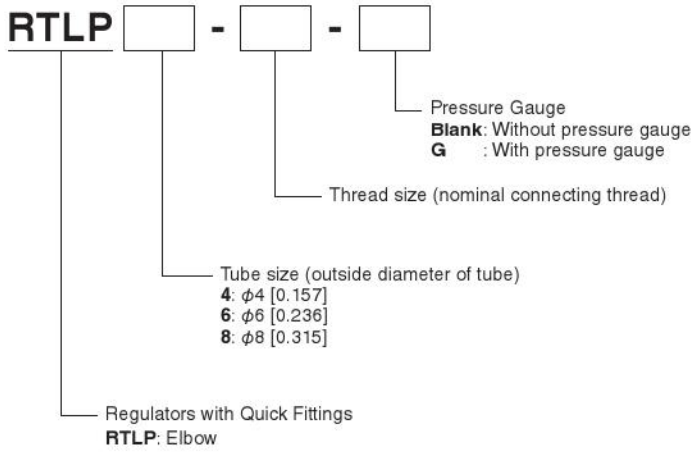

Elbow without pressure gauge



Elbow with pressure gauge

Tube size	Screw size		
	M5x0.8	R1/8	R1/4
4	M5	01	-
6	M5	01	02
8	-	01	02

● Union

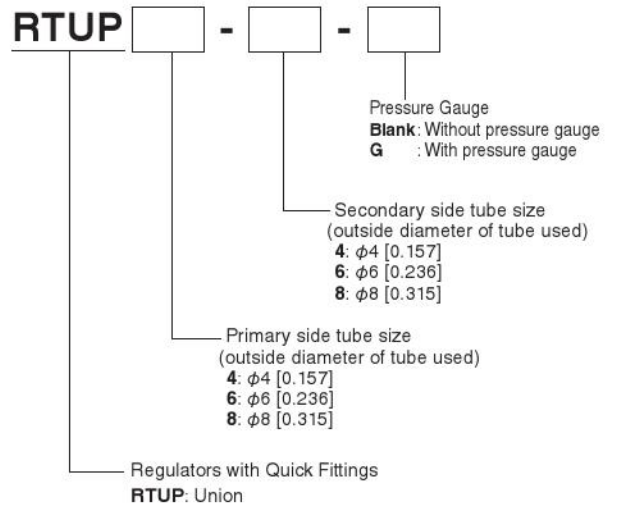

Union without pressure gauge







Union with pressure gauge

Primary side Tube size	Secondary side tube size		
	$\phi 4$ [0.157]	$\phi 6$ [0.236]	$\phi 8$ [0.315]
4	4	-	-
6	4	6	-
8	-	6	8

Before selecting and using an appropriate product, please read all the safety precautions carefully to ensure proper product use. The safety precautions described below are intended to help you use the product safely and correctly and to prevent injury to you or other people and damage to property.

Always adhere to the following safety regulations: ISO4414 (Pneumatic fluid power - General rules and safety requirements for systems and their components) and JIS B 8370 (Pneumatic system regulations).

The directions are classified according to the degree of potential danger or damage as DANGER, WARNING, CAUTION, and ATTENTION.

 DANGER	Indicates situations that can be clearly predicted as dangerous. Death or serious injury may result if the situation is not avoided. It could also result in damage or destruction of assets.
 WARNING	Indicates situations that, while not immediately dangerous, could become dangerous. Death or serious injury may result if the situation is not avoided. It could also result in damage or destruction of assets.
 CAUTION	Indicates situations that, while not immediately dangerous, could become dangerous. Minor or semi-serious injury may result if the situation is not avoided. It could also result in damage or destruction of assets.
 ATTENTION	Indicates no risk of injury, but gives points that should be observed for proper use of the product.

■ This product was designed and manufactured as a part for use in general industrial machinery.

- When selecting and handling equipment, the system designer or another person with sufficient knowledge and experience should always read the safety precautions, catalog, instruction manual and other literature before commencing operation. Improper handling is dangerous.
- After reading the "Owner's Manual", catalog, and other documentation, store them in a location where they are easily available for reference by users of this product.
- Whenever transferring or lending the product to another person, always attach the instruction manual, and other information to the product where they are easily visible in order to ensure that the new user can use the product safely and properly.
- The danger, warning and caution items listed in these safety precautions do not cover all possible contingencies. Read the catalog and instruction manual carefully, and always keep safety first.

 **DANGER**

- Do not use the product for the purposes listed below:
 1. Medical equipment related to maintenance or management of human life or health
 2. Machines or equipment designed for the purpose of moving or transporting people
 3. Critical safety components in mechanical devices
 This product has not been planned or designed for purposes that require high levels of safety. Using the product in any of the ways described above creates the risk of loss of human life.
- Do not use the product in locations with dangerous substances such as flammable or ignitable substances. This product is not explosion-proof. There is a risk of ignition and fire.
- When mounting the product, always make sure it is firmly supported and secured (including the workpiece). If the product tips over, drops, or malfunctions, there is a risk of personal injury.
- Never modify the product. Abnormal operation can lead to injury.
- Never inappropriately disassemble/assemble or repair the basic structure, performance, or functions of the product. Doing so may cause injury.
- Do not splash water on the product. Splashing water on the product, washing the product, or using the product under water may cause abnormal operation leading to injury, etc.
- While the product is operating, avoid touching it with your hands or otherwise approaching too close. Also, do not attempt to make any adjustments to internal or attached mechanisms, or to perform any type of adjustment (releasing a lock, disconnecting tubes or sealed plugs, adjusting the installation position of the product, etc.) while the product is operating.
If the product drops, malfunctions, or sprays medium, there is a risk of personal injury.

 **WARNING**

- Koganei products can be used under a variety of conditions. Therefore, the person responsible for system design must fully evaluate the products to determine compatibility with the system.
The designer who determines the suitability of the system is responsible for guarantying the desired performance and safety of the system. Safe and reliable system configuration (e.g., failsafe) is required considering the possibility of equipment failure through adequate verification and evaluation of the specifications based on the latest catalog and other technical documents.
- Do not use the product in excess of its specification range. Using the product outside its specified range causes it to malfunction, stop functioning, and break. Also, significantly reduced service life results.
- Before supplying air to the product and before starting operation, be sure to confirm that the operating range of the device is safe. Unintentional supply of air creates the risk of injury due to contact with moving parts.
- Do not allow the product to be thrown into fire. Doing so creates the risk of the product exploding or the release of toxic gases.
- Do not sit, stand, or place objects on the product. Doing so creates the risk of injury due to tripping or the product tipping over or falling, resulting in product damage and abnormal, erratic, or runaway operation.
- Before various types of work on the product, such as maintenance inspections, repairs, or parts replacement, be sure to completely disconnect the air supply, and confirm that pressure inside the product and piping connected to the product is zero. In particular, be aware that pressure remains in the compressor and air tank.
The actuator may move abruptly if residual air pressure remains inside the piping, causing injury.

- Design equipment, as well as safety circuits, so that people are not injured and equipment is not damaged if there is an emergency stop, power outage, or other system abnormality that stops the machinery.
- Always check the catalog and other reference materials for correct product piping. Improper piping creates the risk of abnormal operation of the actuator.
- Do not use the product near the ocean, in direct sunlight, near mercury vapor lamps, or near equipment that generates ozone. Deterioration of rubber parts caused by ozone may reduce performance and functions, or stop functions. (except for ozone-resistant products)
- Do not use media other than the ones listed in the specification table. Using a medium not listed in the specification table could lead to a short-term stoppage of functions, sudden degradation in performance, or reduced operating life.
- Do not use the product in the vicinity of heat sources or radiated heat.
- Always lock the adjustment knob before starting normal operations.
Erratic operation could result.
- Do not use the product in locations subject to direct sunlight (ultraviolet radiation); in locations subjected to high temperature or humidity; in locations where dust, salt, or iron particles are present; or in locations with media and/or an ambient atmosphere that includes organic solvents, phosphate ester type hydraulic oil, sulfur dioxide gas, chlorine gas, acids, etc. It could lead to early shutdown of some functions, a sudden degradation of performance, and a reduced operating life. For information about materials, refer to "Materials of Major Parts."
- Do not use the product where the secondary pressure fluctuates extremely or the pressure exceeds the set value. The product is not designed to be a relief valve, so the doing so could result in damage to devices or degraded operations. Install separate safety equipment to use the product in such cases.

CAUTION

- When installing the product, be sure to allow adequate work space around it. Failure to leave working space will make it more difficult to conduct daily inspections or maintenance, which could eventually lead to system shutdown or damage to the product.
- Do not deform, scratch, or mar the main unit by sitting, standing or placing objects on the product. Doing so could result in operations stopping or performance falling due to the product being damaged or broken.
- When doing installation or adjustment work, clearly display work-in-progress signs so that the air supply is not turned on unintentionally. Unintentional supply of air creates the risk of injury due to sudden operation.
- Pneumatic equipment is not completely air-leak-free. Designs should take into consideration the capacity and retention time required for pressure retention within the pressure vessel, etc.
A reduction in retention force can lead to workpieces falling, position deviation, damage to equipment, and injury.

ATTENTION

- Whenever considering use of this product in situations or environments not specifically noted in the catalog or in manuals, or in applications where safety is an important requirement such as in aircraft facilities, combustion equipment, leisure equipment, safety equipment, and other places where human life or assets may be greatly affected, take adequate safety precautions such as allowing plenty of margin for ratings and performance, and fail-safe measures. Contact Koganei regarding use in such applications.
- Wear protective gloves, safety glasses, safety shoes, and other protective clothing as necessary to be safe when handling the product.
- When the product can no longer be used or is no longer necessary, dispose of it appropriately as industrial waste.
- Pneumatic equipment can exhibit degraded performance and functions over its operating life. Always conduct daily inspections on pneumatic equipment and confirm that all requisite system functions are satisfied to prevent accidents from happening.
- For inquiries about the product, consult your nearest Koganei sales office or the Overseas Department. The addresses and telephone numbers are shown on the back cover of this catalog.

Other precautions

- Always observe the following items.
 1. When using this product in a pneumatic system, use only genuine Koganei parts or compatible parts (recommended parts).
Use only genuine Koganei parts or compatible parts (recommended parts) to do maintenance or repairs.
Use only specified procedures and methods.
 2. Never inappropriately disassemble or modify the product in relation to its basic construction, performance, or functions.

Warranty and General Disclaimer

1. Warranty Period

The warranty period of Koganei products is one year from the date of delivery.

* Some products have a two-year warranty period. For details, contact the nearest Koganei sales office or Overseas Department.

2. Scope of Warranty and General Disclaimer

- (1) If a failure attributable to Koganei is found in a product purchased from Koganei or an authorized retailer/dealer during the warranty period, Koganei will repair or replace it free of charge. For some products, a service life, such as the number of operations, may be specified in their warranty periods. For details, contact the nearest Koganei sales office or the Overseas Department.
- (2) The Koganei product warranty covers that product alone. Consequently, Koganei is not responsible for any incidental damage (including costs incurred for the repair and replacement of the product) attributable to any failure of the Koganei product, decrease in function, or decrease in performance.
- (3) Koganei is not responsible for any losses or for any damages to other machinery caused by breakdown, loss of function, or loss of performance of Koganei products.
- (4) Koganei is not responsible for any losses due to use or storage of the product in a way that is outside of the product specifications prescribed in Koganei catalogs and instruction manuals, and/or due to actions that violate the mounting, installation, adjustment, maintenance or other safety precautions.
- (5) Koganei is not responsible for any losses caused by breakdown of the product due to factors outside the responsibility of Koganei, including but not limited to fire, natural disaster, the actions of third parties, and intentional actions or errors by the purchaser.

● Pressure Adjustment Method

1. Adjusting the pressure

Adjusting the pressure is done by pulling the pressure adjustment knob up so the lock is released.

When doing this, do not apply too much force to the pressure adjustment knob. Doing so could result in damage.

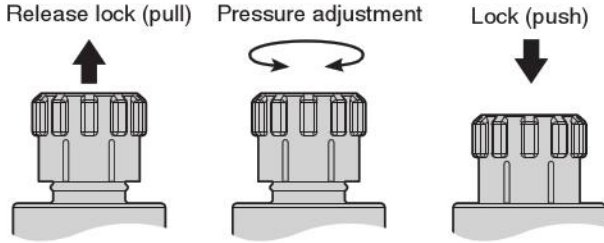

2. Increase pressure

Rotate the regulator's pressure adjustment knob clockwise from the fully open position to increase the pressure.

When you reach the desired pressure, be sure to press the pressure adjustment knob to lock it so the set pressure does not deviate.

3. Reduce pressure

If you rotate the regulator's pressure adjustment knob too far (pressure becomes too high), rotate it counterclockwise to activate the relief mechanism and reduce the pressure. After that, adjust it the same as in "2. To increase pressure". When you reach the desired pressure, be sure to press the pressure adjustment knob to lock it so the set pressure does not deviate.

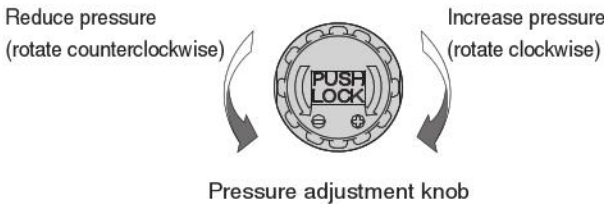

- Note**
1. Set the pressure by increasing the pressure (rotating clockwise). You cannot make an accurate setting by lowering the pressure (rotating counterclockwise).
 2. Do not rotate the pressure adjustment knob excessively counterclockwise when it is fully open nor clockwise when it is fully closed. Doing so could cause damage to the pressure adjustment knob or main unit. Furthermore, doing so could cause increased torque for the pressure adjustment knob, due to the pressure adjustment screw and pressure adjustment nut becoming stuck.
 3. The pressure adjustment knob locks when pushed and releases when pulled. After adjustments, always lock it. If not locked, the knob could rotate and change the pressure while the product is being used.
 4. The pressure adjustment knob may stop at an intermediate point, between locked and unlocked, when pushed, depending on the rotational position. In this state, the pressure adjustment knob is not completely locked, so confirm that it is pressed all the way to the locked position.
 5. Do not forcibly rotate the pressure adjustment knob while it is locked. Doing so could damage the lock mechanism.
 6. Pressure gauge on models with pressure gauges can be rotated to any orientation. Applying excessive pressure to the pressure gauge cap may result in faulty readings or damage to the pressure gauge, so grip it near the base when rotating it.
 7. The accuracy of the pressure indicator of the pressure gauge is $\pm 5\%$ (F.S.). If accuracy is necessary, use a separate suitable pressure gauge to check and adjust the pressure.

8. Opening the secondary side to the atmosphere may cause sympathetic vibrations due to the affect on the flow rate. There is a risk of malfunctions occurring, such as internal damage, so avoid using the product for long periods while the secondary side is open to the atmosphere.

● Installation (for RTLP □ - □)

1. Precautions for installing the main unit

- ① Use an appropriate tool on the hexagonal exterior of the main unit to tighten it.
- ② When installing a threaded part, tighten it to the recommended torque in the following table. Tightening it more than the tightening torque could damage the threads or deform the gasket, and cause leaks. Also, tightening it less than the recommended tightening torque could cause the threads to be loose and leak.

Recommended tightening torque

Screw type	Screw size	Tightening torque
Metric threads (mm [in.])	M5x0.8	1 to 1.5 N·m [8.851 to 13.277 in·lbf]
Tapered threads for pipes	R1/8	4.5 to 6.5 N·m [39.830 to 57.532 in·lbf]
	R1/4	7 to 9 N·m [61.957 to 79.659 in·lbf]

2. Precautions for removing the main unit

- ① Use an appropriate tool on the hexagonal exterior of the main unit to remove it.
- ② Remove the sealant stuck to the threads on the other parts after removal. Sealant that is stuck to the parts could get into peripheral equipment and cause damage.

3. Tightening threaded parts

Use a wrench on the hexagonal exterior to tighten the threaded part.

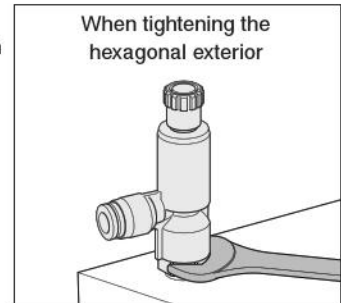

- Note**
1. The sealant on the regulators with quick fittings can be reused multiple times, as is. However, the sealant may stick to the threaded parts of other devices. Be sure to clean the inside of the female threads on the devices.
 2. When installing tubing, hold the tightening tool horizontally in relation to the hexagonal faces of the main unit. If you allow it to touch the plastic part of the main unit, as shown in the figure, you could damage the main unit.

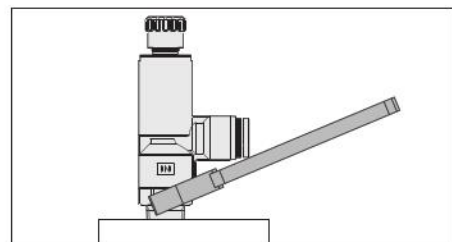

● **Connecting/disconnecting tubes**

Precautions for attaching tubes

- ① Confirm that the cut ends of the tubes are cut at right angles, that the outsides of the tubes are not scratched, and that the tubes are not oval.
- ② When attaching tubes, if they are not inserted all the way to their ends, they could leak.

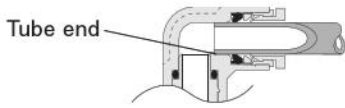

- ③ After attaching the tube, pull on it to confirm it does not come out.
- ④ Do not pointlessly press on the release ring before attaching a tube. Doing so could cause the tube to come out.

Precautions for removing tubes

- ① Confirm that the pressure inside the tubes is zero before removing tubes.
- ② Push the release ring evenly to the back and then pull out the tube toward you. If you do not push enough, the tube may not come out or chips scraped from the tube could be left inside the fitting.

How to connect/disconnect tubes

① Connecting tubes

For regulators with quick fittings, just insert the tube to its end so the flexible sleeve seals around the outside of the tube.

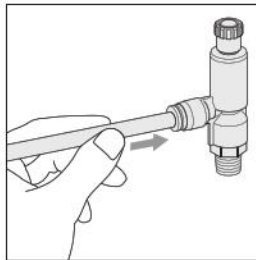

② Removing tubes

When removing a tube, pressing the release ring opens the lock claw so the tube can be released. Be sure to turn off the air before removing tubes.

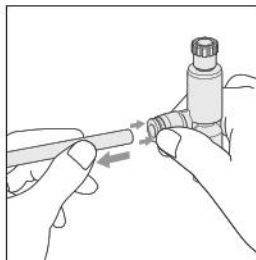

If removing pipes is difficult because the piping space is constricted, consult your nearest Koganei sales office for a specialized tool that is available.

Specialized tool for removing tubes

For $\phi 3$ [0.118], $\phi 4$ [0.157], and $\phi 6$ [0.236] tubes

Order code: **UJ-1**



For $\phi 6$ [0.236], $\phi 8$ [0.315], $\phi 10$ [0.394], and $\phi 12$ [0.472] tubes

Order code: **UJ-2**



● **Usable tubes**

Either nylon or urethane tubes can be used. Use tubes that have the following exterior diameter accuracy: Nylon tubes nominal dimensions within ± 0.1 mm [0.004 in.], urethane tubes nominal dimensions within ± 0.15 mm [0.006 in.], and ovalness (difference of long and short diameters) within 0.2 mm [0.008 in.]. (We recommend using Koganei tubes.) Note that if you use tubes other than Koganei genuine tubes or compatible tubes (recommended tubes), problems could occur, such as tubes detaching or air leaking, so be sure to check the compressed air system before assembling it.



- 1. Use tubes that have no scratches on their outer surfaces. If they become scratched due to repeated use, replace those parts.
- 2. Do not allow tubing to become severely bent or twisted near the fitting. Doing so could cause air leakage. The following table shows the minimum bending radius when using nylon or urethane tubes.
- 3. Do not use extremely soft tubes, which need very little force to remove.
- 4. Be sure to turn off the air supply before connecting/disconnecting tubes. Also, be sure to check that all the air has been exhausted from the tubing before starting.

mm [in.]

Tube size	Minimum bending radius	
	Nylon tube	Urethane tube
$\phi 4$ [0.157]	20 [0.787]	10 [0.394]
$\phi 6$ [0.236]	30 [1.181]	15 [0.591]
$\phi 8$ [0.315]	50 [1.969]	20 [0.787]

Dimensions (Elbow without pressure gauge) (mm [in.])

RTLP □ - □



Metric threads (mm [in.])

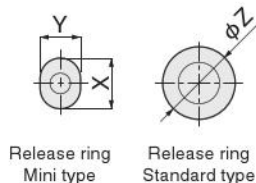
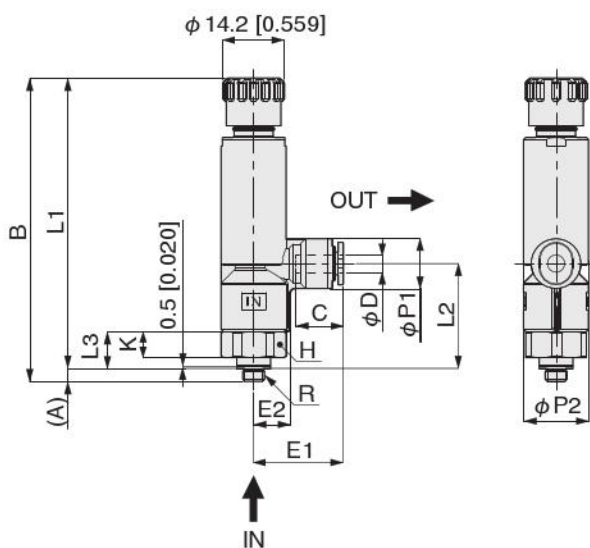

Tapered threads for pipes

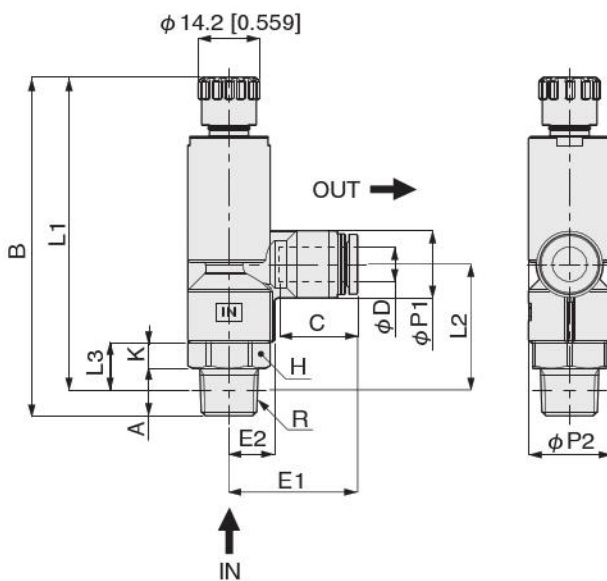

Standard model	Tube diameter ϕD	R	A	B		L1		L2	L3	$\phi P1$	$\phi P2$	Tube end C	E1	E2	Width across flats H	K	Release ring			Mass (g [oz])
				MAX.	MIN.	MAX.	MIN.										Exterior diameter ϕZ	X	Y	
RTLP4-M5	4 [0.157]	M5x0.8	3 [0.118]	70 [2.756]	67.4 [2.654]	67 [2.638]	64.4 [2.535]	24.2 [0.953]	8.5 [0.335]	11.5 [0.453]	15 [0.591]	11 [0.433]	20.7 [0.815]	8.5 [0.335]	14 [0.551]	6 [0.236]	-	9.8 [0.386]	7.8 [0.307]	26 [0.92]
RTLP4-01		R1/8	8 [0.315]	71.5 [2.815]	68.9 [2.713]	67.5 [2.657]	64.9 [2.555]	24.7 [0.972]	9 [0.354]											
RTLP6-M5	6 [0.236]	M5x0.8	3 [0.118]	70 [2.756]	67.4 [2.654]	67 [2.638]	64.4 [2.535]	24.2 [0.953]	8.5 [0.335]	11.5 [0.453]	15 [0.591]	11.6 [0.457]	21.1 [0.831]	8.5 [0.335]	14 [0.551]	6 [0.236]	-	11.8 [0.465]	9.8 [0.386]	26 [0.92]
RTLP6-01		R1/8	8 [0.315]	71.5 [2.815]	68.9 [2.713]	67.5 [2.657]	64.9 [2.555]	24.7 [0.972]	9 [0.354]											
RTLP6-02		R1/4	11 [0.433]	78.2 [3.079]	75.6 [2.976]	72.2 [2.843]	69.6 [2.740]	29 [1.142]	11 [0.433]											
RTLP8-01	8 [0.315]	R1/8	8 [0.315]	71.5 [2.815]	68.9 [2.713]	67.5 [2.657]	64.9 [2.555]	24.7 [0.972]	9 [0.354]	15.5 [0.610]	15 [0.591]	18.1 [0.713]	27.7 [1.091]	8.5 [0.335]	14 [0.551]	5 [0.197]	-	-	-	29 [1.02]
RTLP8-02		R1/4	11 [0.433]	78.2 [3.079]	75.6 [2.976]	72.2 [2.843]	69.6 [2.740]	29 [1.142]	11 [0.433]											

Note: The L1 and L2 dimensions for the tapered threads for pipes are reference dimensions for after tightening.

Dimensions (Elbow with pressure gauge) (mm [in.])

RTLP □ - □ - G

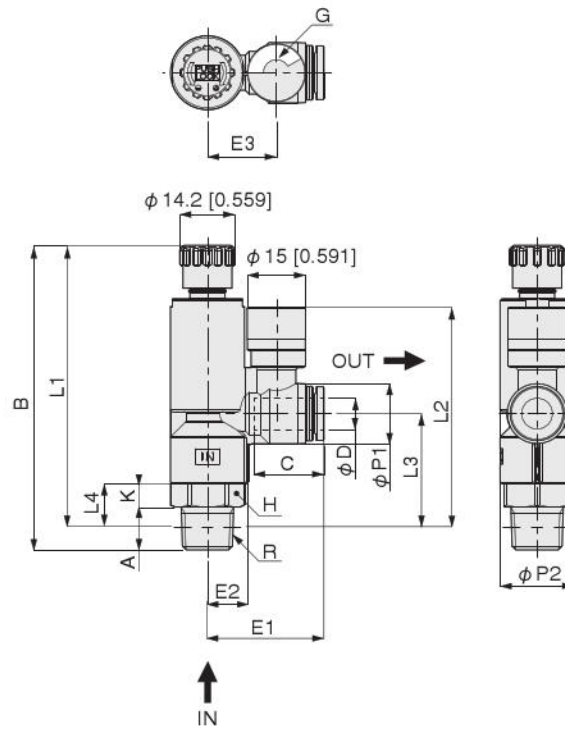
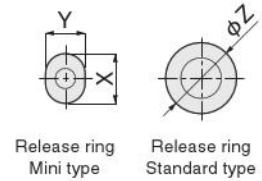
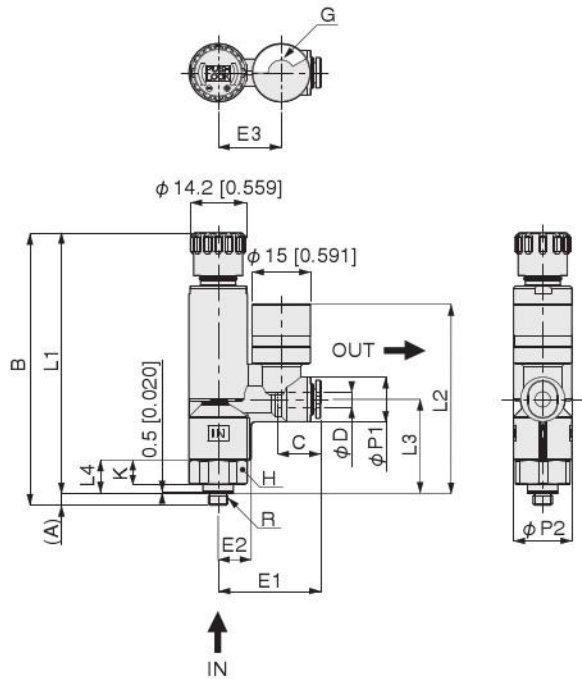

Standard model	Tube outside diameter ϕD	R	A	B		L1		L2	L3	L4	$\phi P1$	$\phi P2$	Tube end C	E1	E2	E3	Width across flats H	K	Release ring			Mass (g [oz])											
				MAX.	MIN.	MAX.	MIN.												Exterior diameter ϕZ	X	Y												
RTLP4-M5-G	4 [0.157]	M5x0.8	3	70	674	67	64.4	48.7	24.2	8.5	11.5	15	11	26.3	8.5	16.2	14	6	-	9.8	7.8	29											
RTLP4-01-G			8	71.5	68.9	67.5	64.9	49.2	24.7	9													[0.453]	[0.591]	[0.433]	[1.035]	[0.335]	[0.638]	[0.551]	[0.236]	[0.386]	[0.307]	[1.02]
RTLP6-M5-G	6 [0.236]	M5x0.8	3	70	674	67	64.4	48.7	24.2	8.5	11.5	15	11.6	26.7	8.5	16.2	14	6	-	11.8	9.8	29											
RTLP6-01-G			8	71.5	68.9	67.5	64.9	49.2	24.7	9													[0.453]	[0.591]	[0.457]	[1.051]	[0.335]	[0.638]	[0.551]	[0.236]	[0.465]	[0.386]	[1.02]
RTLP6-02-G			11	78.2	75.6	72.2	69.6	56.3	29	11													[0.610]	[0.748]	[0.669]	[1.181]	[0.413]	[0.697]	[0.669]	[0.236]	[0.465]	-	-
RTLP8-01-G	8 [0.315]	R1/8	8	71.5	68.9	67.5	64.9	52	24.7	9	15.5	15	18.1	28.4	8.5	16.2	14	5	-	-	31												
RTLP8-02-G			11	78.2	75.6	72.2	69.6	56.3	29	11												[0.610]	[0.748]	[0.713]	[1.177]	[0.413]	[0.697]	[0.669]	[0.236]	[0.543]	-	-	49

Note: The L1 and L2 dimensions for the tapered threads for pipes are reference dimensions for after tightening.

Dimensions (Union without pressure gauge) (mm [in.])

RTUP □ - □

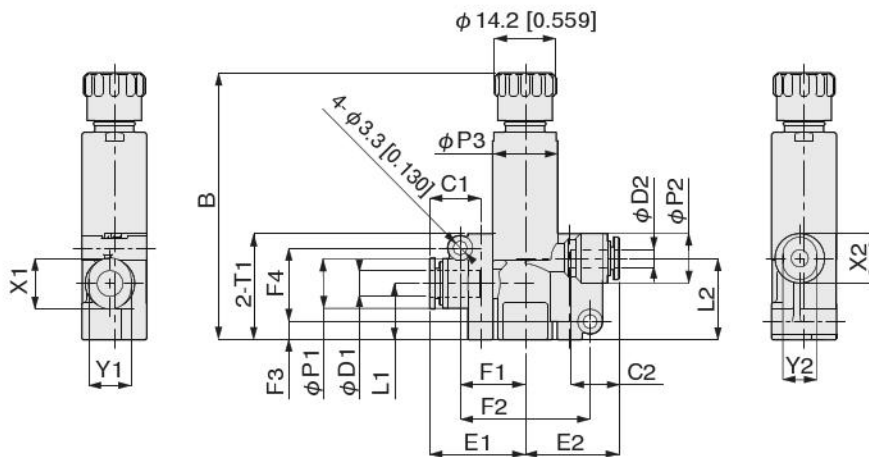
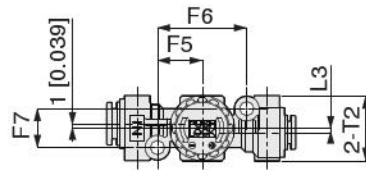
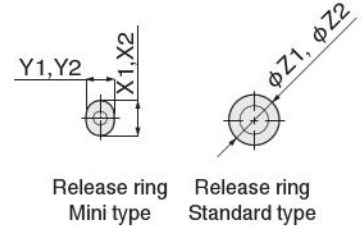

Standard model	Tube diameter φD1	Tube diameter φD2	B		L1	L2	L3	φP1	φP2	φP3	Tube end C1	Tube end C2	E1	E2
			MAX.	MIN.										
RTUP4-4	4 [0.157]	4 [0.157]	61.6 [2.425]	59 [2.323]	13 [0.512]	18.8 [0.740]	1 [0.039]	11.5 [0.453]	11.5 [0.453]	15 [0.591]	11 [0.433]	11 [0.433]	21.6 [0.850]	21.6 [0.850]
RTUP6-4	6 [0.236]	4 [0.157]	61.6 [2.425]	59 [2.323]	13 [0.512]	18.8 [0.740]	1 [0.039]	11.5 [0.453]	11.5 [0.453]	15 [0.591]	11.6 [0.457]	11 [0.433]	22 [0.866]	21.6 [0.850]
RTUP6-6		6 [0.236]										11.6 [0.457]		
RTUP8-6	8 [0.315]	6 [0.236]	65.7 [2.587]	63.1 [2.484]	15 [0.591]	22.5 [0.886]	-	15.5 [0.610]	15.5 [0.610]	19 [0.748]	18.1 [0.713]	17 [0.669]	28.6 [1.126]	28.7 [1.130]
RTUP8-8		8 [0.315]										18.1 [0.713]		

Standard model	F1	F2	F3	F4	F5	F6	F7	T1	T2	Release ring						Mass (g [oz])
										φZ1	X1	Y1	φZ2	X2	Y2	
RTUP4-4	15 [0.591]	30 [1.181]	4.2 [0.165]	17 [0.669]	10.3 [0.406]	20.6 [0.811]	9 [0.354]	24.5 [0.965]	15 [0.591]	-	9.8 [0.386]	7.8 [0.307]	-	9.8 [0.386]	7.8 [0.307]	19 [0.67]
RTUP6-4	15 [0.591]	30 [1.181]	4.2 [0.165]	17 [0.669]	10.3 [0.406]	20.6 [0.811]	9 [0.354]	24.5 [0.965]	15 [0.591]	-	11.8 [0.465]	9.8 [0.386]	-	9.8 [0.386]	7.8 [0.307]	20 [0.71]
RTUP6-6														11.8 [0.465]	9.8 [0.386]	
RTUP8-6	19.8 [0.780]	39.6 [1.559]	4 [0.157]	21.5 [0.846]	11.7 [0.461]	23.4 [0.921]	13 [0.512]	28.4 [1.118]	19 [0.748]	13.8 [0.543]	-	-	11.8 [0.465]	-	-	32 [1.13]
RTUP8-8													13.8 [0.543]			

Dimensions (Union with pressure gauge) (mm [in.])

RTUP □ - □ - G

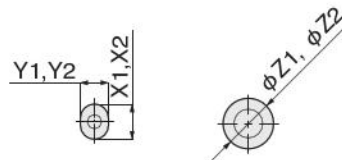

Release ring Mini type Release ring Standard type



Enlarged view of G

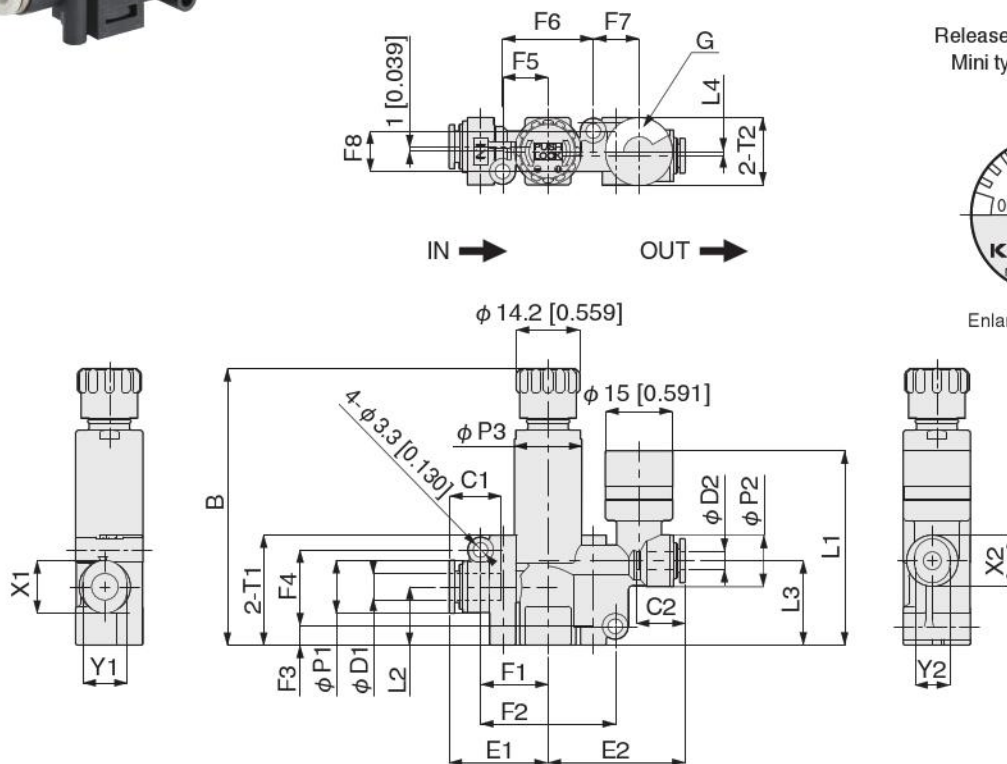

Standard model	Tube diameter φD1	Tube diameter φD2	B		L1	L2	L3	L4	φP1	φP2	φP3	Tube end C1	Tube end C2	E1	E2
			MAX.	MIN.											
RTUP4-4-G	4 [0.157]	4 [0.157]	61.6 [2.425]	59 [2.323]	43.3 [1.705]	13 [0.512]	18.8 [0.740]	1 [0.039]	11.5 [0.453]	11.5 [0.453]	15 [0.591]	11 [0.433]	11 [0.433]	21.6 [0.850]	30.6 [1.205]
RTUP6-4-G	6 [0.236]	4 [0.157]	61.6 [2.425]	59 [2.323]	43.3 [1.705]	13 [0.512]	18.8 [0.740]	1 [0.039]	11.5 [0.453]	11.5 [0.453]	15 [0.591]	11.6 [0.457]	11 [0.433]	22 [0.866]	30.6 [1.205]
RTUP6-6-G		6 [0.236]											11.6 [0.457]	31 [1.220]	
RTUP8-6-G	8 [0.315]	6 [0.236]	65.7 [2.587]	63.1 [2.484]	49.8 [1.961]	15 [0.591]	22.5 [0.886]	-	15.5 [0.610]	15.5 [0.610]	19 [0.748]	18.1 [0.713]	17 [0.669]	28.6 [1.126]	33 [1.299]
RTUP8-8-G		8 [0.315]											18.1 [0.713]	32.9 [1.295]	

Standard model	F1	F2	F3	F4	F5	F6	F7	F8	T1	T2	Release ring						Mass (g [oz])
											φZ1	X1	Y1	φZ2	X2	Y2	
RTUP4-4-G	15 [0.591]	30 [1.181]	4.2 [0.165]	17 [0.669]	10.1 [0.398]	20.2 [0.795]	10.2 [0.402]	9 [0.354]	24.5 [0.965]	15 [0.591]	-	9.8 [0.386]	7.8 [0.307]	-	9.8 [0.386]	7.8 [0.307]	23 [0.81]
RTUP6-4-G	15 [0.591]	30 [1.181]	4.2 [0.165]	17 [0.669]	10.1 [0.398]	20.2 [0.795]	10.2 [0.402]	9 [0.354]	24.5 [0.965]	15 [0.591]	-	11.8 [0.465]	9.8 [0.386]	-	9.8 [0.386]	7.8 [0.307]	23 [0.81]
RTUP6-6-G															11.8 [0.465]	9.8 [0.386]	
RTUP8-6-G	19.9 [0.783]	39.7 [1.563]	4.1 [0.161]	21.3 [0.839]	11.6 [0.457]	23.2 [0.913]	9.1 [0.358]	13 [0.512]	28.4 [1.118]	19 [0.748]	13.8 [0.543]	-	-	11.8 [0.465]	-	-	36 [1.27]
RTUP8-8-G														13.8 [0.543]	-	-	

Flow rate characteristics, pressure characteristics

Flow rate characteristics

RTL4-M5, RTL4-M5-G

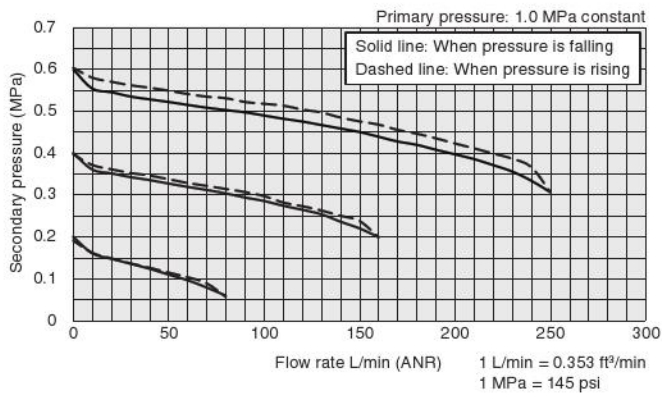

Flow rate characteristics

RTL6-M5, RTL6-M5-G

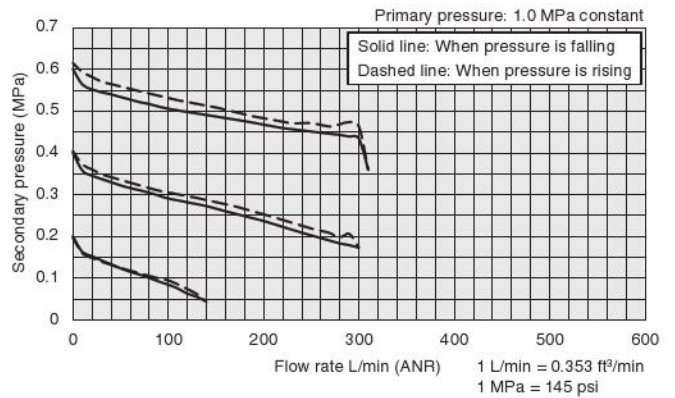

Pressure characteristics ^{Note 1}

RTL4-M5, RTL4-M5-G

RTL6-M5, RTL6-M5-G

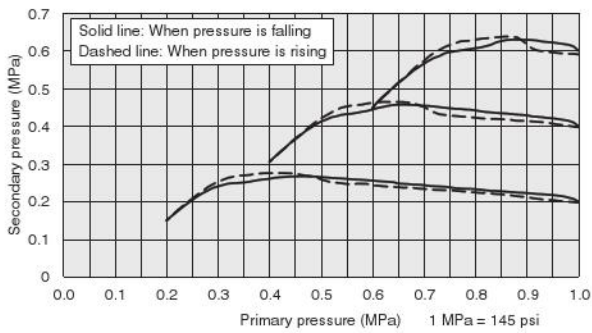

Free flow rate ^{Note 2}

RTL4-M5, RTL4-M5-G

RTL6-M5, RTL6-M5-G

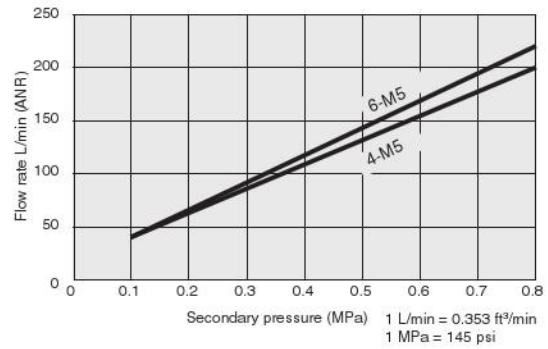

Note 1: Fluctuation of primary pressure 1.0 MPa [145 psi] → Rated pressure (0.2, 0.4, 0.6 MPa [29, 58, 87 psi]) → 1.0 MPa [145 psi].

Note 2: Flow rate from secondary side → primary side.

Flow rate characteristics, pressure characteristics

Flow rate characteristics

RTL4-01, RTL4-01-G

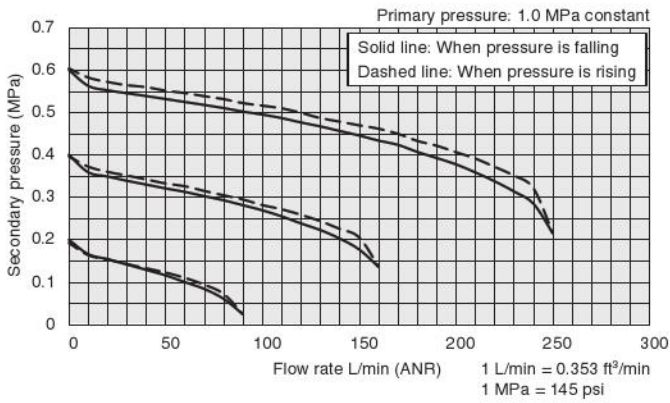

Flow rate characteristics

RTL6-01, RTL6-01-G

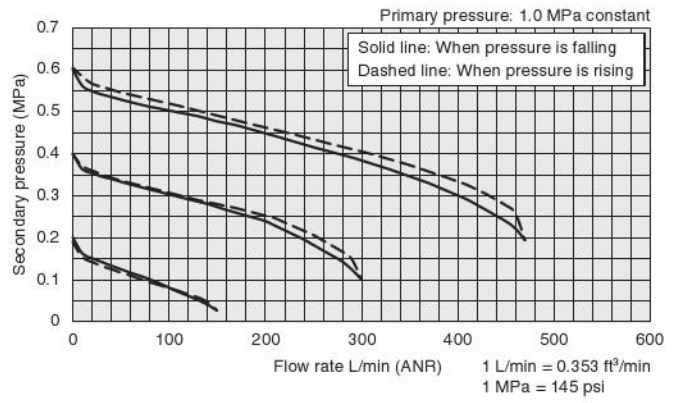

Flow rate characteristics

RTL8-01, RTL8-01-G

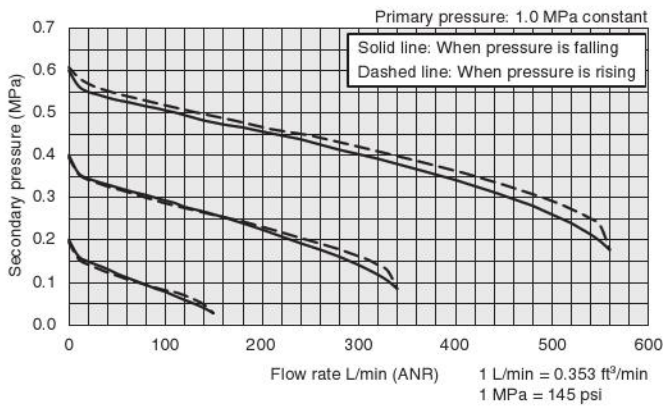

Pressure characteristics ^{Note 1}

RTL4-01, RTL4-01-G

RTL6-01, RTL6-01-G

RTL8-01, RTL8-01-G

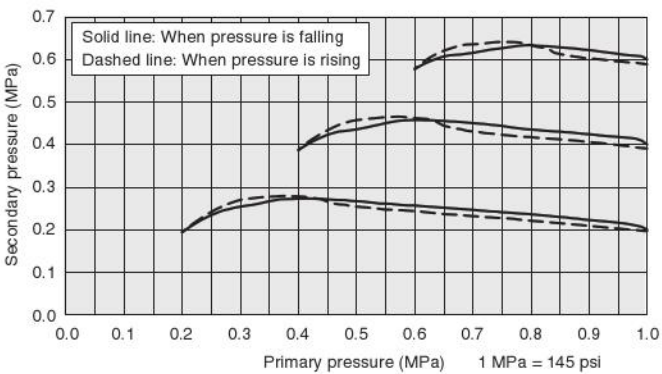

Free flow rate ^{Note 2}

RTL4-01, RTL4-01-G

RTL6-01, RTL6-01-G

RTL8-01, RTL8-01-G

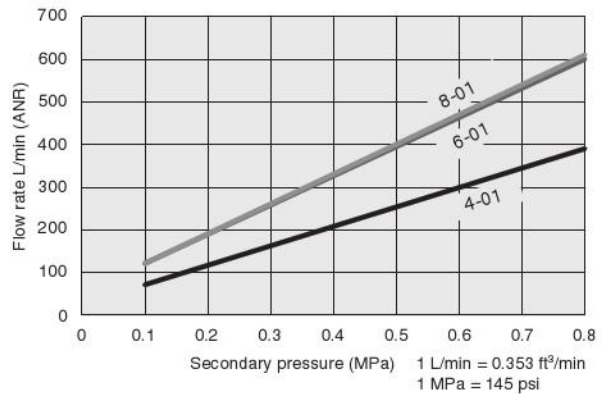

Note 1: Fluctuation of primary pressure 1.0 MPa [145 psi] → Rated pressure (0.2, 0.4, 0.6 MPa [29, 58, 87 psi]) → 1.0 MPa [145 psi].

2: Flow rate from secondary side → primary side.

Flow rate characteristics, pressure characteristics

Flow rate characteristics RTL6-02, RTL6-02-G

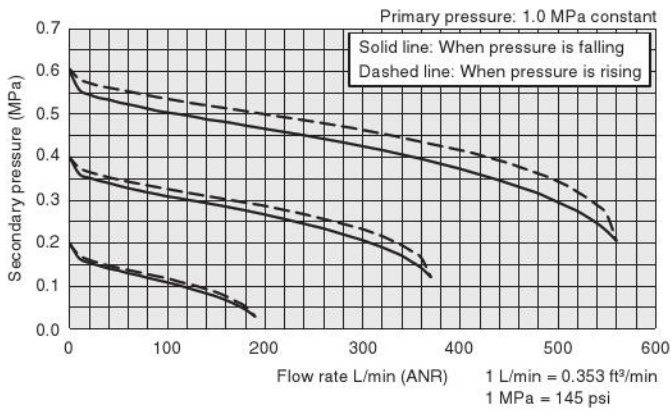

Flow rate characteristics RTL8-02, RTL8-02-G

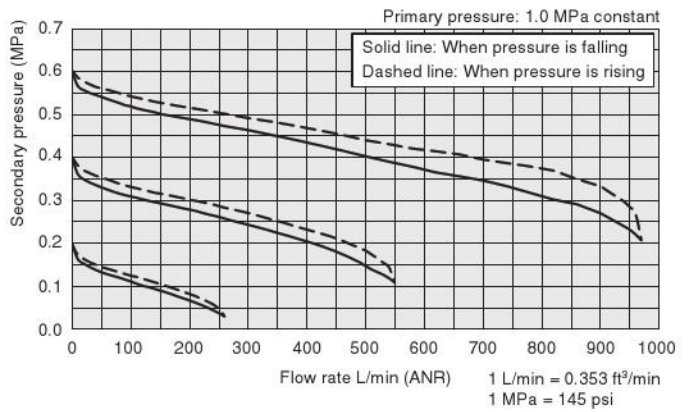

Pressure characteristics ^{Note 1} RTL6-02, RTL6-02-G RTL8-02, RTL8-02-G

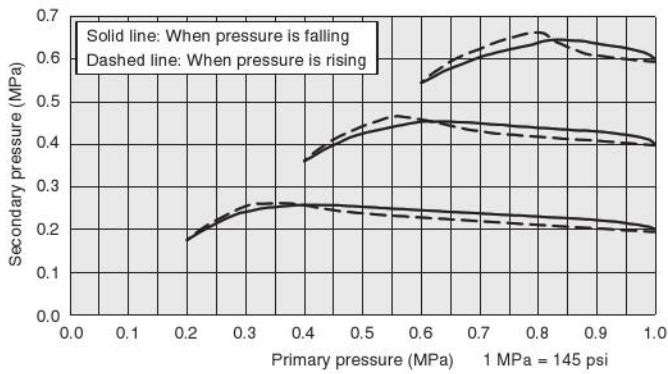

Free flow rate ^{Note 2} RTL6-02, RTL6-02-G RTL8-02, RTL8-02-G

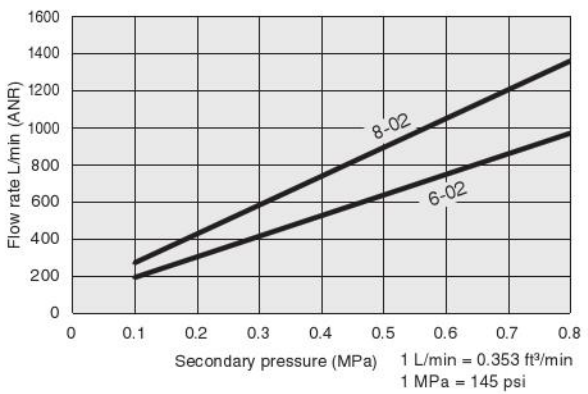

Note 1: Fluctuation of primary pressure 1.0 MPa [145 psi] → Rated pressure (0.2, 0.4, 0.6 MPa [29, 58, 87 psi]) → 1.0 MPa [145 psi].
 2: Flow rate from secondary side → primary side.

Flow rate characteristics, pressure characteristics

Flow rate characteristics RTUP4-4, RTUP4-4-G

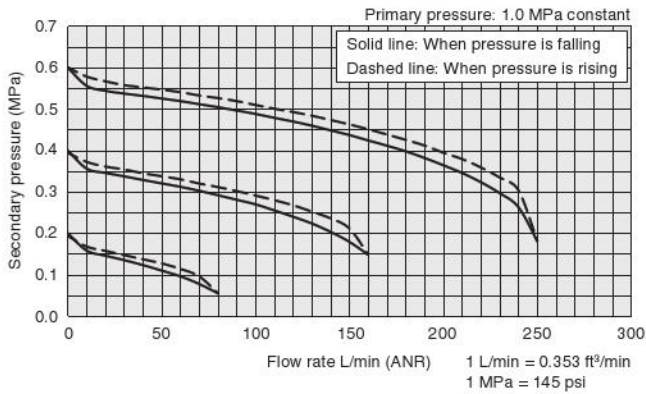

Flow rate characteristics RTUP6-4, RTUP6-4-G

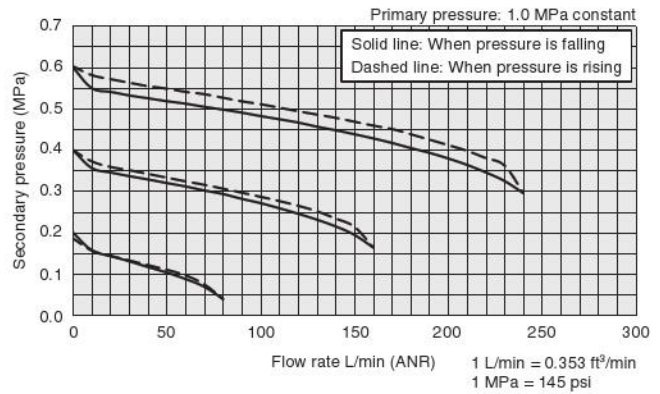

Flow rate characteristics RTUP6-6, RTUP6-6-G

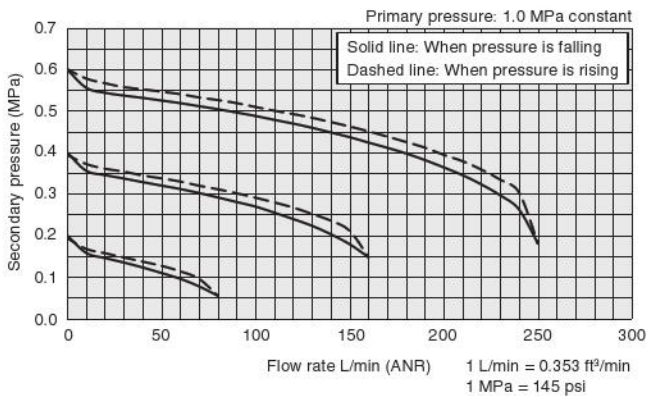

Pressure characteristics ^{Note 1} RTUP4-4, RTUP4-4-G RTUP6-4, RTUP6-4-G RTUP6-6, RTUP6-6-G

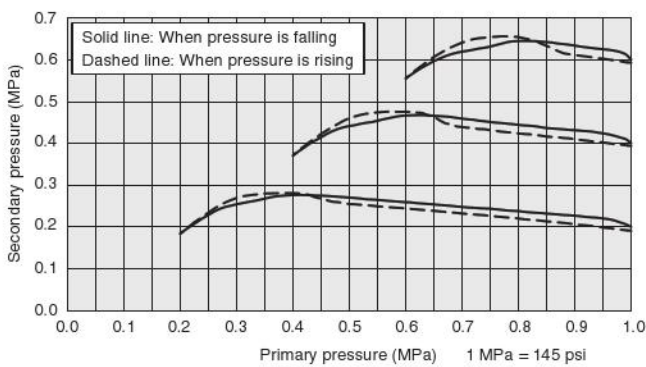

Free flow rate ^{Note 2} RTUP4-4, RTUP4-4-G RTUP6-4, RTUP6-4-G RTUP6-6, RTUP6-6-G

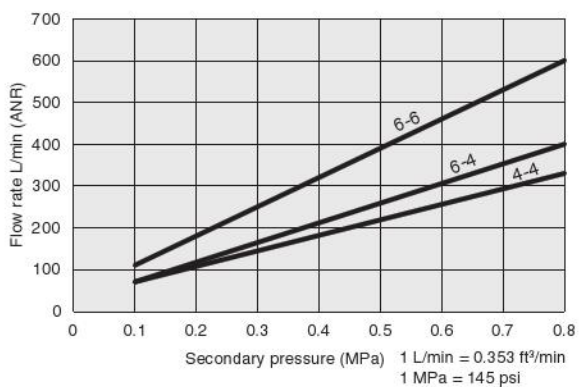

Note 1: Fluctuation of primary pressure 1.0 MPa [145 psi] → Rated pressure (0.2, 0.4, 0.6 MPa [29, 58, 87 psi]) → 1.0 MPa [145 psi].

2: Flow rate from secondary side → primary side.

Flow rate characteristics, pressure characteristics

Flow rate characteristics RTUP8-6, RTUP8-6-G

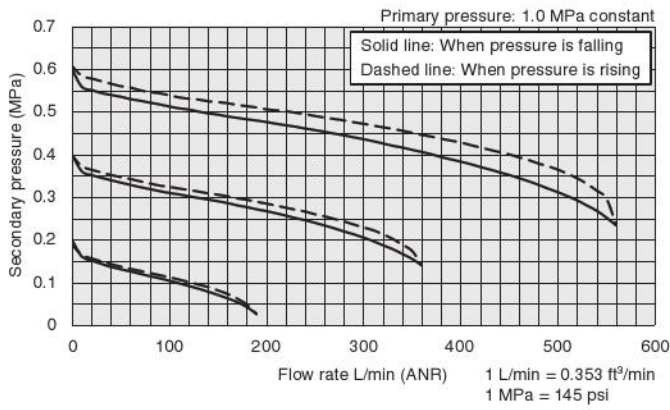

Flow rate characteristics RTUP8-8, RTUP8-8-G

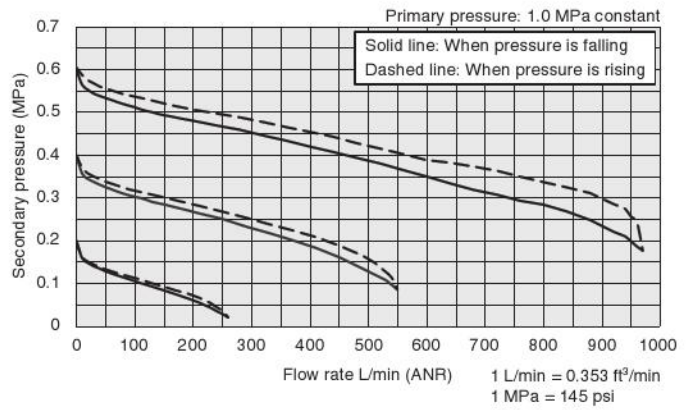

Pressure characteristics ^{Note 1} RTUP8-6, RTUP8-6-G RTUP8-8, RTUP8-8-G

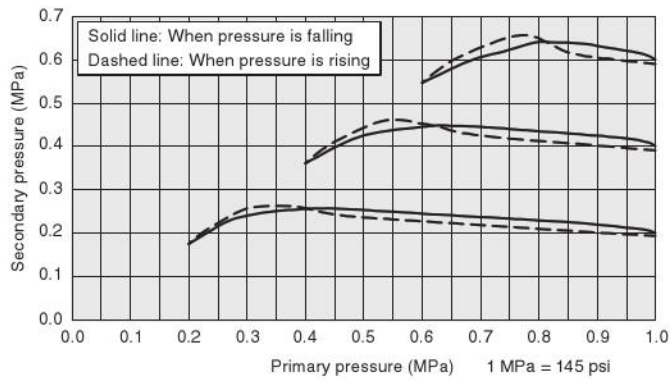

Free flow rate ^{Note 2} RTUP8-6, RTUP8-6-G RTUP8-8, RTUP8-8-G

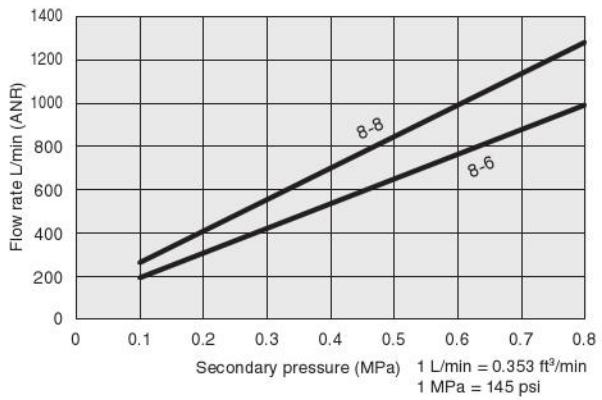

Note 1: Fluctuation of primary pressure 1.0 MPa [145 psi] → Rated pressure (0.2, 0.4, 0.6 MPa [29, 58, 87 psi]) → 1.0 MPa [145 psi].
 Note 2: Flow rate from secondary side → primary side.

Limited Warranty

KOGANEI CORP. warrants its products to be free from defects in material and workmanship subject to the following provisions.

Warranty Period The warranty period is 180 days from the date of delivery.

Koganei Responsibility If a defect in material or workmanship is found during the warranty period, KOGANEI CORP. will replace any part proved defective under normal use free of charge and will provide the service necessary to replace such a part.

Limitations

- This warranty is in lieu of all other warranties, expressed or implied, and is limited to the original cost of the product and shall not include any transportation fee, the cost of installation or any liability for direct, indirect or consequential damage or delay resulting from the defects.

- KOGANEI CORP. shall in no way be liable or responsible for injuries or damage to persons or property arising out of the use or operation of the manufacturer's product.

- This warranty shall be void if the engineered safety devices are removed, made inoperative or not periodically checked for proper functioning.

- Any operation beyond the rated capacity, any improper use or application, or any improper installation of the product, or any substitution upon it with parts not furnished or approved by KOGANEI CORP., shall void this warranty.

- This warranty covers only such items supplied by KOGANEI CORP. The products of other manufacturers are covered only by such warranties made by those original manufacturers, even though such items may have been included as the components.

The specifications are subject to change without notice.

URL <http://www.koganei.co.jp>

E-mail: overseas@koganei.co.jp



KOGANEI CORPORATION

OVERSEAS DEPARTMENT

3-11-28, Midori-cho, Koganei City, Tokyo 184-8533, Japan
Tel: 81-42-383-7271 Fax: 81-42-383-7276

KOGANEI INTERNATIONAL AMERICA, INC.

48860 Millmont Drive, suite 108C, Fremont, California 94538
Tel: 1-510-744-1626 Fax: 1-510-744-1676

SHANGHAI KOGANEI INTERNATIONAL TRADING CORPORATION

Room 2606-2607, Tongda Venture Building No.1, Lane 600, Tianshan Road,
Shanghai, 200051, China
Tel: 86-21-6145-7313 Fax: 86-21-6145-7323

TAIWAN KOGANEI TRADING CO., LTD.

Rm. 2, 13F., No88, Sec. 2, Zhongxiao E. Rd., Zhongzheng Dist., Taipei City 100,
Taiwan (ROC)
Tel: 886-2-2393-2717 Fax: 886-2-2393-2719

KOGANEI KOREA CO., LTD.

6F-601, Tower Bldg., 1005, Yeongdeong-dong, Giheung-gu, Yongin-si, Gyeonggi-do,
446-908, Korea
Tel: 82-31-246-0414 Fax: 82-31-246-0415

KOGANEI (THAILAND) CO., LTD.

555 Rasa Tower 1, 12th Floor, Unit 1202 and 1207, Phaholyothin Road,
Chatuchak, Chatuchak, Bangkok 10900 Thailand
Tel: 66-2-937-4250 Fax: 66-2-937-4254

KOGANEI AUTOMATION (MALAYSIA) SDN.BHD.

Suite 29-2, Level 29, Menara 1MK, No.1, Jalan Kiara, Mont Kiara
50480, Kuala Lumpur, Malaysia
Tel: 60-12-537-7086

KOGANEI ASIA PTE. LTD.

69 Ubi Road 1, #05-18 Oxley Bizhub, Singapore 408731
Tel: 65-6293-4512 Fax: 65-6293-4513