

# KOGANEI

## ACCESSORIES GENERAL CATALOG

AIR TREATMENT, AUXILIARY, VACUUM,  
AND FLUORORESIN PRODUCTS

## QUICK FITTINGS WITH STOP VALVES

### CONTENTS



Specifications, Order Codes, Size Table	363
Dimensions	364
NCU Specification, Non-lubricant Specification	
Order Codes, Model Table	366
Safety Precautions, Handling Instructions and Precautions	367

QUICK FITTINGS WITH STOP VALVES

 **Caution** Before use, be sure to read the "Safety Precautions" on p. 49.

# QUICK FITTINGS WITH STOP VALVES

- Come with a stop mechanism that automatically shuts off the air flow if a tube is disconnected.
- Hard to be pressure exerted construction, to ease tube connection and disconnection.

## Symbol



## Specifications

Media	Air
Maximum operating pressure	0.9MPa [131psi.]
Operating vacuum pressure	-100kPa [-24.54in.Hg]
Operating temperature range	0~60°C [32~140°F]
Recommended tube	Nylon tube, urethane tube
Sales unit	1 pc.

Remark: Supplied with a gasket or sealant coated.

## Inner Construction, Major Parts and Materials

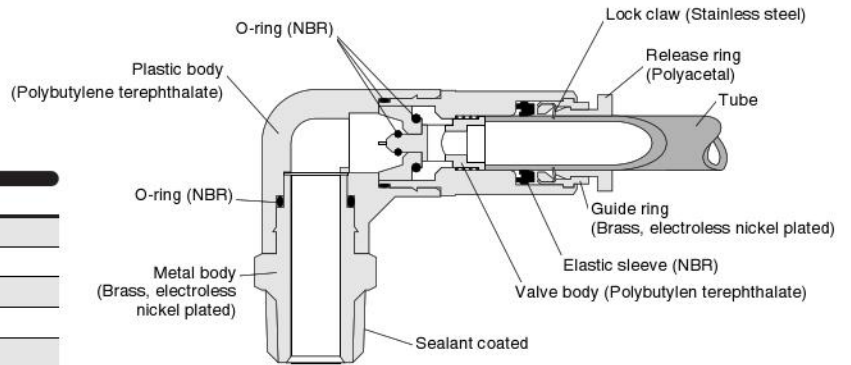

## Order Codes

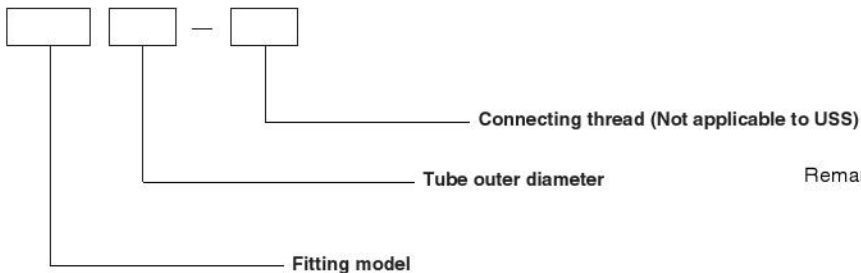

Remark: For the NCU and non-lubricant specifications, see p.366.

※For the fitting models, the tube size, and thread size combinations, see the table below.

### ● TSS Straight 364



Tube size	Thread size				
	M5X0.8	R1/8	R1/4	R3/8	R1/2
4	M5	01	—	—	—
6	M5	01	02	—	—
8	—	01	02	03	—
10	—	—	02	03	04
12	—	—	—	03	04

### ● TLS Elbow 364



Tube size	Thread size				
	M5X0.8	R1/8	R1/4	R3/8	R1/2
4	M5	01	—	—	—
6	M5	01	02	—	—
8	—	01	02	03	—
10	—	—	02	03	04
12	—	—	—	03	04

### ● USS Union straight 365



Tube size
4
6
8
10
12

## Dimensions (mm)

### Straight TSS

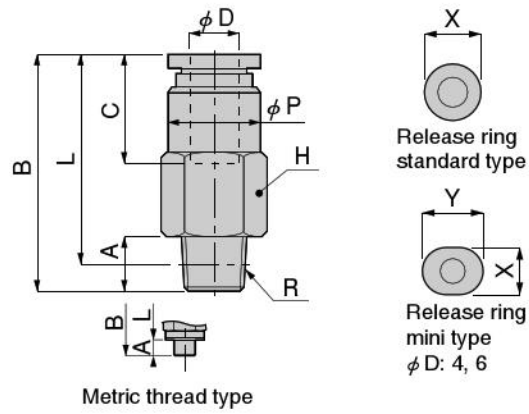

Model	Tube outer diameter $\phi D$	R	A	B	L <sup>Note</sup>	$\phi P$	C	Width across flats H	X	Y	Effective area (mm <sup>2</sup> )	Mass (g) [oz.]	
TSS4-M5	4	M5×0.8	3	28.4	25.4	8	12.1	8	7.8	9.8	1.6	7 [0.247]	
TSS4-01		R1/8	8	23.9	19.9	8.8		10			2	9.6 [0.339]	
TSS6-M5	6	M5×0.8	3	31.7	28.7	10	13.4	10	9.8	11.8	2.3	12 [0.42]	
TSS6-01		R1/8	8	26.9	22.9			12			14	7.3	9.2 [0.325]
TSS6-02		R1/4	11		20.9			12			14	22 [0.78]	
TSS8-01	8	R1/8	8	35.7	31.7	14	22.3	14	13.8	—	9.1	23 [0.81]	
TSS8-02		R1/4	11	36	30		18.3				17		14.2
TSS8-03		R3/8	12		29.7		15				17		15.8
TSS10-02	10	R1/4	11	38.3	32.3	17	24.7	17	16.8	—	17.8	32 [1.13]	
TSS10-03		R3/8	12	39.8	33.5		20.7				21	24.9	37 [1.31]
TSS10-04		R1/2	15		31.6		18				20.7	21	64 [2.26]
TSS12-03	12	R3/8	12	45.8	39.5	20.8	29.1	21	19.8	—	28.8	65 [2.29]	
TSS12-04		R1/2	15	45.9	37.7		23.1				21	31.8	66 [2.33]

Note: The L dimensions for the tapered thread type are the reference dimensions after the fittings are assembled.

### Elbow TLS

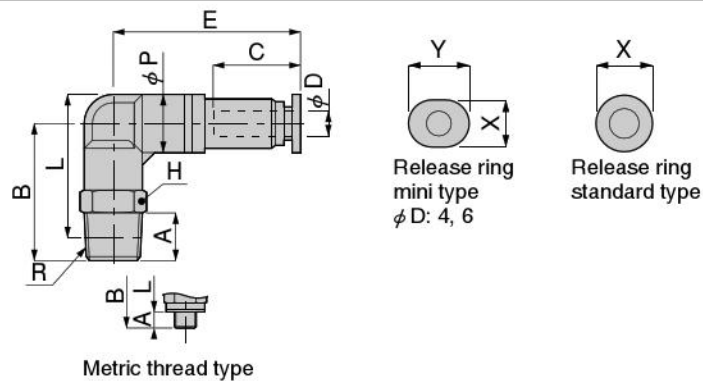

Model	Tube outer diameter $\phi D$	R	A	B	L <sup>Note</sup>	$\phi P$	C	E	Width across flats H	X	Y	Effective area (mm <sup>2</sup> )	Mass (g) [oz.]
TLS4-M5	4	M5×0.8	3	20.3	22.3	10	12.1	29.7	10	7.8	9.8	1.5	13 [0.46]
TLS4-01		R1/8	8	23.3	24.3							1.8	16 [0.56]
TLS6-M5	6	M5×0.8	3	22	25.3	12.5	13.4	30.1	12	7.8	9.8	2.3	20 [0.71]
TLS6-01		R1/8	8	25	27.3							6.8	22 [0.78]
TLS6-02		R1/4	11	28	28.2							8.1	30 [1.06]
TLS8-01	8	R1/8	8	28	31.3	14.5	18.3	43	14	13.8	—	13.7	35 [1.23]
TLS8-02		R1/4	11	31	32.2							13.2	41 [1.45]
TLS8-03		R3/8	12	32.8	33.7							17	14.5
TLS10-02	10	R1/4	11	36	38.7	17.5	20.7	49.3	17	16.8	—	21.4	59 [2.08]
TLS10-03		R3/8	12	37	39.4							21.9	67 [2.36]
TLS10-04		R1/2	15	40	40.6							21.3	90 [3.17]
TLS12-03	12	R3/8	12	39	43.2	21	23.1	57.1	21	19.8	—	30.2	92 [3.25]
TLS12-04		R1/2	15	42	44.3							29.8	108 [3.81]

Note: The L dimensions for the tapered thread type are the reference dimensions after the fittings are assembled.

**Dimensions (mm)**

**Union straight  
USS**

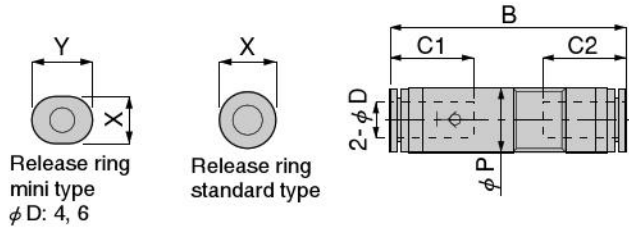

Model	Tube outer diameter $\phi D$	B	$\phi P$	C1	C2	X	Y	Effective area (mm <sup>2</sup> )	Mass (g) [oz.]
<b>USS4</b>	4	35.6	8.5	12.2	11	7.8	9.8	2	3.8 [0.134]
<b>USS6</b>	6	38.8	11	13.3	11.6	7.8	9.8	7.1	5.9 [0.208]
<b>USS8</b>	8	54.2	14.5	18.2	18.1	13.8	—	15.4	17 [0.60]
<b>USS10</b>	10	60	17.5	20.3	20.2	16.8	—	22.4	27 [0.95]
<b>USS12</b>	12	70.2	21	23.2	23.4	19.8	—	30	42 [1.48]

# QUICK FITTINGS WITH STOP VALVES

## NCU Specification and Non-lubricant Specification

### NCU Specification and Non-lubricant Specification

#### ● Order codes

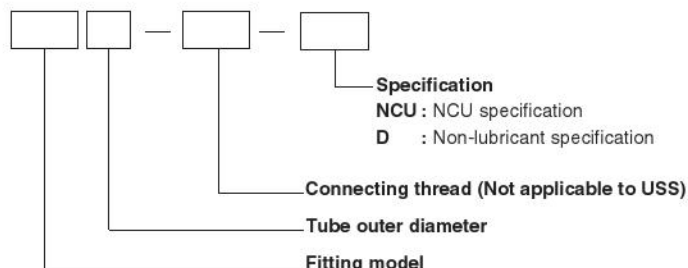

- For specifications, see p.363.
- The dimensions, inner construction, major parts and materials for the NCU specification and non-lubricant specification shown below are the same as the standard type. See inner construction, major parts and materials on p. 363 and dimensions on p. 364~365. The sealant is not applied to the R taper thread portion of the NCU specification fittings.

Caution: For delivery, consult us.

※For the fitting models, the tube size and thread combinations, see the table below. Columns showing the “←” symbol indicate that standard products can be used as the NCU specification. In these cases, place orders for the standard products.

#### ● Model Table (NCU Specification)

Fitting type	Tube outer diameter	Thread	Standard type model (reference)	NCU specification model
Straight TSS	4	M5×0.8	TSS4-M5	←
		R1/8	TSS4-01	TSS4-01-NCU
	6	M5×0.8	TSS6-M5	←
		R1/8	TSS6-01	TSS6-01-NCU
		R1/4	TSS6-02	TSS6-02-NCU
	8	R1/8	TSS8-01	TSS8-01-NCU
		R1/4	TSS8-02	TSS8-02-NCU
		R3/8	TSS8-03	TSS8-03-NCU
	10	R1/4	TSS10-02	TSS10-02-NCU
		R3/8	TSS10-03	TSS10-03-NCU
		R1/2	TSS10-04	TSS10-04-NCU
	12	R3/8	TSS12-03	TSS12-03-NCU
R1/2		TSS12-04	TSS12-04-NCU	
Elbow TLS	4	M5×0.8	TLS4-M5	←
		R1/8	TLS4-01	TLS4-01-NCU
	6	M5×0.8	TLS6-M5	←
		R1/8	TLS6-01	TLS6-01-NCU
		R1/4	TLS6-02	TLS6-02-NCU
	8	R1/8	TLS8-01	TLS8-01-NCU
		R1/4	TLS8-02	TLS8-02-NCU
		R3/8	TLS8-03	TLS8-03-NCU
	10	R1/4	TLS10-02	TLS10-02-NCU
		R3/8	TLS10-03	TLS10-03-NCU
		R1/2	TLS10-04	TLS10-04-NCU
	12	R3/8	TLS12-03	TLS12-03-NCU
R1/2		TLS12-04	TLS12-04-NCU	
Union straight USS	4	—	USS4	←
	6	—	USS6	←
	8	—	USS8	←
	10	—	USS10	←
	12	—	USS12	←

#### ● Model Table (Non-lubricant Specification)

Fitting type	Tube outer diameter	Thread	Standard type model (reference)	Non-lubricant specification model
Straight TSS	4	M5×0.8	TSS4-M5	TSS4-M5-D
		R1/8	TSS4-01	TSS4-01-D
	6	M5×0.8	TSS6-M5	TSS6-M5-D
		R1/8	TSS6-01	TSS6-01-D
		R1/4	TSS6-02	TSS6-02-D
	8	R1/8	TSS8-01	TSS8-01-D
		R1/4	TSS8-02	TSS8-02-D
		R3/8	TSS8-03	TSS8-03-D
	10	R1/4	TSS10-02	TSS10-02-D
		R3/8	TSS10-03	TSS10-03-D
		R1/2	TSS10-04	TSS10-04-D
	12	R3/8	TSS12-03	TSS12-03-D
R1/2		TSS12-04	TSS12-04-D	
Elbow TLS	4	M5×0.8	TLS4-M5	TLS4-M5-D
		R1/8	TLS4-01	TLS4-01-D
	6	M5×0.8	TLS6-M5	TLS6-M5-D
		R1/8	TLS6-01	TLS6-01-D
		R1/4	TLS6-02	TLS6-02-D
	8	R1/8	TLS8-01	TLS8-01-D
		R1/4	TLS8-02	TLS8-02-D
		R3/8	TLS8-03	TLS8-03-D
	10	R1/4	TLS10-02	TLS10-02-D
		R3/8	TLS10-03	TLS10-03-D
		R1/2	TLS10-04	TLS10-04-D
	12	R3/8	TLS12-03	TLS12-03-D
R1/2		TLS12-04	TLS12-04-D	
Union straight USS	4	—	USS4	USS4-D
	6	—	USS6	USS6-D
	8	—	USS8	USS8-D
	10	—	USS10	USS10-D
	12	—	USS12	USS12-D

## Safety Precautions (Quick Fittings with Stop Valves)

The following is a safety precaution to Quick Fittings with Stop Valves. For other safety precautions, be sure to read the precautions on p.49.

### Warning

● With the exception of the Quick Fittings Rotary Type, do not use any quick fitting in locations where thread portions or tubes are subject to swing or rotation. The swing or rotation could result in damage to the fitting body.

- Be aware when attempting to disconnect a tube from a Quick Fitting with Stop Valve while the system is still applied internal pressure, because the internal pressure could cause the tube to fly off.
- Use the symbol on the main body to check the direction of the check valve operation. Note that the air will not stop if a tube is disconnected in the direction opposite to the check valve operation.

## Handling Instructions and Precautions

### ● Mounting

#### Precautions for mounting the body

1. To mount the body, use a suitable tool to tighten it to the outer or inner hexagonal section of the fitting.
2. When tightening screws, tighten to the recommended tightening torque shown in the table below. Tightening to more than the recommended torque could result in broken threads or air leaks due to deformed gaskets. Tightening to less than the recommended torque could lead to loose screws or air leaks.
3. For fittings with fixed piping direction, tighten to the desired piping direction, and then adjust so that it falls within the range of the body tightening torque.

Recommended tightening torque, sealant color, and gasket material

thread type	Thread size	Tightening torque	Sealant color	Gasket material
Metric thread	M5×0.8	1.0~1.5N·m [8.9~13.3in·lbf]	—	SUS304 NBR
	M6×1	1.8~2.3N·m [15.9~20.4in·lbf]		
Taper pipe thread	R1/8	7~9N·m [62~80in·lbf]	White	—
	R1/4	12~14N·m [106~124in·lbf]		
	R3/8	22~24N·m [195~212in·lbf]		
	R1/2	28~30N·m [248~266in·lbf]		

#### Precautions for disconnecting the body

1. To disconnect the body, use a suitable tool to loosen it from the outer or inner hexagonal section of the body.
2. Clean off the sealant coating on the thread of the removed mating part. The coated sealant could enter other relating parts, and cause breakdowns.

#### Method for tightening screws

For tightening screws, use a wrench on outer hexagonal section.

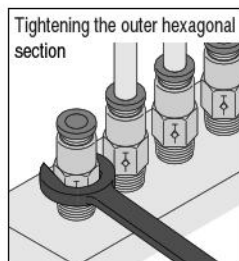

**Caution:** While the quick fitting sealant can be reused a number of times, the thread on the mating part may also be adhered with sealant. Always clean out the inside of the equipment's female thread.

### ● Tube connection and disconnection

#### Precautions for connecting the tube

1. Check that the cut section of the tube has been cut at straight angle, that the outer surface of the tube is not scratched, and that the tube has not become oval shaped.
2. When connecting a tube, failure to insert the tube all the way to the end could result in air leaks.

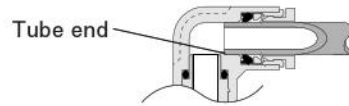

3. After connection, pull the tube to check that it will not disconnect.

#### Precautions for disconnecting the tube

1. Before disconnecting a tube, check that the pressure inside the tube is down to zero.
2. Push the release ring evenly all the way to the end, and then pull the tube out. An insufficient push could make it impossible to pull the tube out, or could scratch the tube, leaving scratched tube material inside the fitting.

#### Tube connection and disconnection method

##### 1. Tube connection

The Quick Fitting with Stop Valve is equipped with a lock claw that holds the tube in place when it has been pushed all the way to the end, and with an elastic sleeve for sealing the tube periphery.

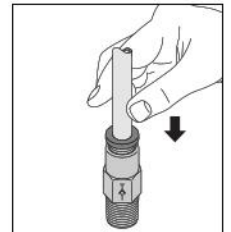

##### 2. Tube disconnection

To disconnect the tube, first push on the release ring, releasing the lock claw, and then pull the tube out. Always stop the air supply before disconnecting the tube.

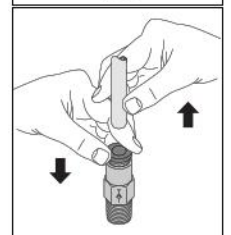

For cases where tight or cramped piping spaces hinder tube removal operations, a special tool is available. Consult us for details.

#### Special tool for tube removal

For  $\phi$  3 [0.118in.],  $\phi$  4 [0.157in.] and  $\phi$  6 [0.236in.] tubes  
Order code : **UJ-1**

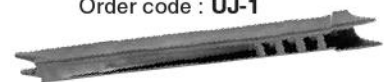

For  $\phi$  6 [0.236in.],  $\phi$  8 [0.315in.],  
 $\phi$  10 [0.394in.] and  $\phi$  12 [0.472in.] tubes  
Order code : **UJ-2**



## Handling Instructions and Precautions

### ● Usable tubes

Either nylon or urethane tubes can be used. The tube outer diameter accuracy should be, for nylon tubes, within  $\pm 0.1\text{mm}$  [ $\pm 0.004\text{in.}$ ] of the nominal dimensions, and for urethane tubes, within  $\pm 0.15\text{mm}$  [ $\pm 0.006\text{in.}$ ] of the nominal dimensions, while the ovalness (difference between long diameter and short diameter) should be within  $0.2\text{mm}$  [ $0.008\text{in.}$ ].

- Cautions:**
1. Use tubes with no visible scratches on the outer surface. If a scratch is made during repeated use, cut off the scratched section.
  2. Do not bend or twist the tube too much near the connection to the fitting. It could result in air leaks. The minimum bending radius for nylon tubes is as shown in the table below.

mm [in.]

Tube size	Minimum bending radius
$\phi 4$ [0.157]	20 [0.8]
$\phi 6$ [0.236]	30 [1.2]
$\phi 8$ [0.315]	50 [2.0]
$\phi 10$ [0.394]	80 [3.2]
$\phi 12$ [0.472]	150 [5.9]