



Energy-saving for air blowing processes

Pulse blow series

Compressed air is not for free!!

Air consumption can be **reduced nearly 50%**

No electricity required!

Generates pulse air without using electricity!



Pulse blow air gun PAG Series



Pulse blow unit PAU Series



Measures to reduce factory air consumption!

Air compressors are said to use about 20% of a factory's overall electric power. About **65%** of that compressed air is usually consumed by blowing air. Pulse blow air gun can reduce the amount of compressed air consumption and help save energy.

World's first!

Pulse blow air gun

PAG Series

No electricity required!

PAT. PEND.

Pulse air generator is built in



Trimmer: Pulse frequency adjustment
Enables you to adjust the frequency with a flat blade screwdriver

Light weight design

194 g [6.84 oz]

* Main unit only

No electricity required
Valve built in

Pulsed air generation unit built in
You only need to connect compressed air

● Pulse blow flow rate guideline: 80 to 145 L/min [2.826 to 5.121 ft³/min]

Nozzle variations
Air amplifier nozzle

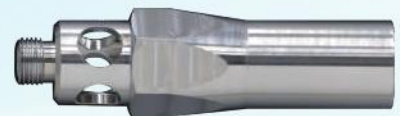

● The air volume is nearly 4.5 time larger
(The flow consumption is the same as that of the standard nozzle ϕ 3 [0.118].)

● Standard nozzle orifice diameters
 ϕ 2 mm [0.079 in.], ϕ 3 mm [0.118 in.], ϕ 4 mm [0.157 in.]

● Long nozzle (orifice diameter: ϕ 2.3 [0.091])
170 mm [6.693 in.], 220 mm [8.661 in.]

CO₂ reduction

We will help you in your **CO₂ reduction activities** (compressor electricity charge reduction).

	Pulse blow air gun Per PAG-2 unit	Standard Per PAU unit	Large flow rate type Per PAU-30 unit	Small-size type Per PAU-05 unit
Electricity amount kWh	2368 → 1184	3068 → 1534	7437 → 3718	794 → 397
CO ₂ kg	1028 → 514	1332 → 666	3228 → 1614	345 → 172
Cost	Reduction of 5,960 yen/year	Reduction of 7,723 yen/year	Reduction of 18,718 yen/year	Reduction of 3,996 yen/year

Remarks: <<Conditions for the above calculations>> The values of "Electricity amount kWh" and "CO₂ kg", show the total amount within the product life.
Daily operating hours: 2 hours, yearly operating days: 240 days, CO₂ emission factor (TEPCO value in 2020): 0.434kg-CO₂/kWh
Cost of compressed air per m³: 2.5 yen, * "Value for continuous blowing" → "pulse blowing" according to our test conditions

Advantages of pulse blowing

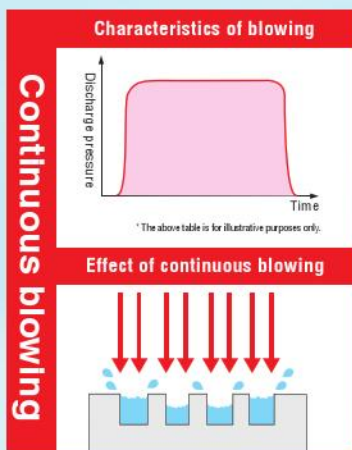

If you replace continuous blowing with pulse blowing!

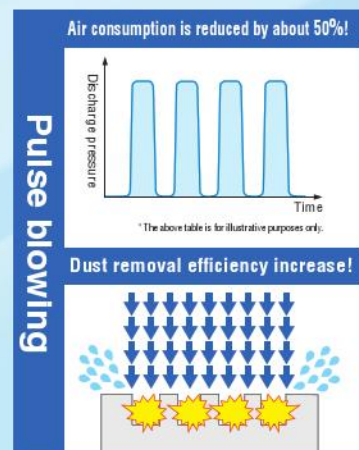

More efficient dust removal!

It is said that pulse air blowing has higher dust removal efficiency than continuous air blowing because it applies impact to the dust removal target intermittently.

No electricity required!

Just attach a pulse blow unit to your air gun to use it as a pulse blow air gun



Applicable examples

Small-size type

PAU-05

- Pulse blow flow rate guideline: 10 to 55 L/min [0.353 to 1.943 ft³/min]
- Small size, light weight
Entire length: 33.8 to 46.6 mm [1.331 to 1.835 in.],
mass: 14 g [0.49 oz], 15 g [0.53 oz]
- Wide pipe variations For details, refer to page ⑩.
IN piping: M5 internal thread, ϕ 4 [0.157] quick fitting,
 ϕ 6 [0.236] quick fitting, Rc1/8, R1/8, G1/8

NEW



-M5 (IN piping, M5 internal thread) -J4 (IN piping, ϕ 4 quick fitting) -J6 (IN piping, ϕ 6 quick fitting) -01A (IN piping, Rc1/8 internal thread) -01B (IN piping, R1/8 external thread) -01C (IN piping, G1/8 external thread)

Standard PAU

- Pulse blow flow rate guideline: 80 to 125 L/min [2.826 to 4.415 ft³/min]

Light weight design
73 g [2.57 oz]

Mountable on a device

Can be mounted and used in air blowing processes by installing an additional mounting bracket.

Main unit: Aluminum material



Trimmer: Pulse frequency adjustment
Enables you to adjust the frequency with a flat blade screwdriver



Large flow rate type PAU-30

- Pulse blow flow rate guidelines: 160 to 270 L/min [5.651 to 9.536 ft³/min]

Double the flow rate!!



Direct mounting type

- Doubled the flow rate for an **improved performance of dust removal** compared to PAU!
- Improved space economy by a volume of **130% (compared to PAU)** despite giving 2 times the flow rate!
- Direct mounting **makes it ideal for installation on your equipment!**
Brackets not required

Applicable examples

- Mount a small-size pulse blow unit at the tip of a piping tube.

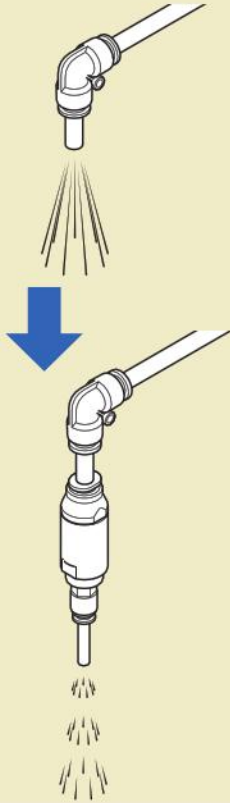

- Mount a small-size pulse blow unit between an air gun and the tip of a nozzle.

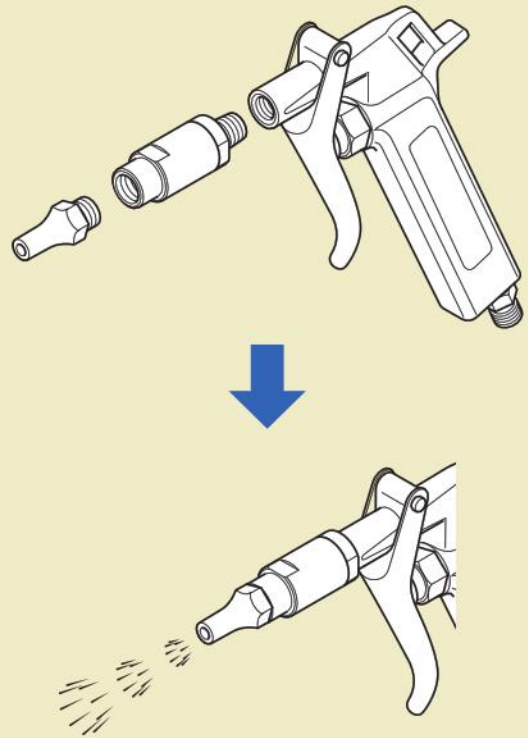

- To remove the dust adhering to the workpieces on a conveyor, mount multiple nozzle-attached small-size pulse blow units.

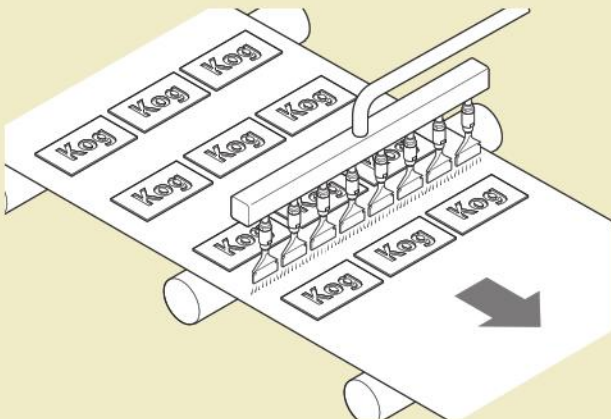

Applicable examples

- To laser-print on workpieces on a conveyor after removing water drops adhering to them, use a nozzle-attached pulse blow unit.

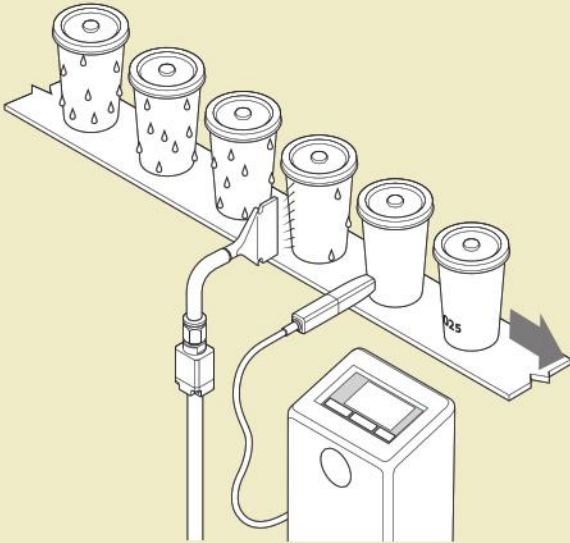

- To remove the dust adhering to the workpieces in a clean box in a simple cleanroom, use a pulse blow unit-attached air gun.

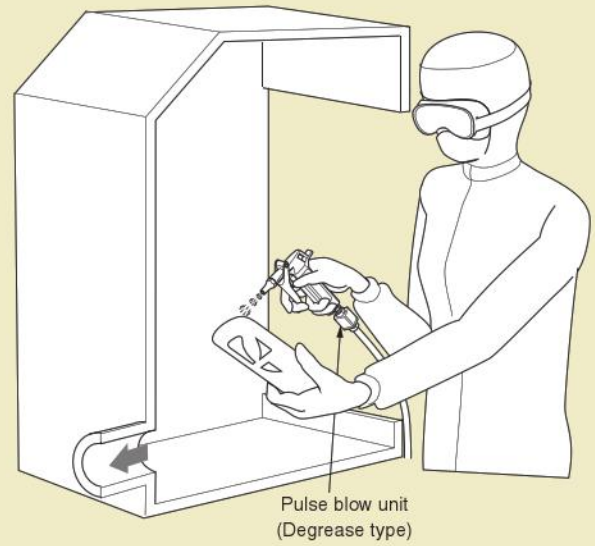

- To remove the dust adhering to the workpieces on a conveyor, mount three nozzle-attached pulse blow units.

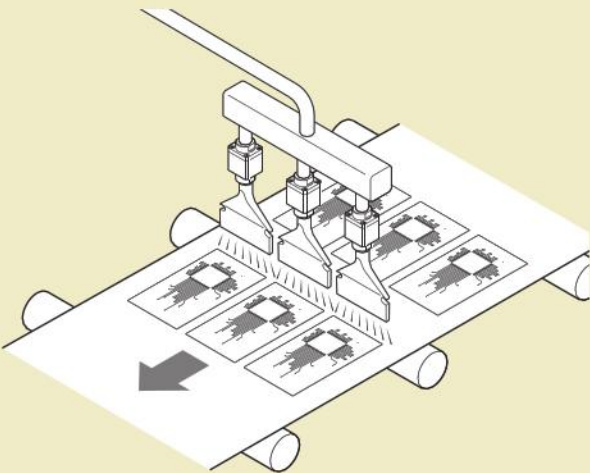

Pulse blow air gun

PAG Series



Specifications

Model		PAG - □
Item		
Medium		Air ^{Note 1}
Lubrication		No
Operating pressure range	MPa [psi]	0.35 to 0.7 [51 to 102]
Operating temperature range	°C [°F]	5 to 50 [41 to 122]
Pulse frequency	Hz	5 to 15
Port size		Piping side: Rc1/4 Nozzle side: G1/8
Nozzle diameter ^{Note 2}	mm [in.]	Standard nozzle: ϕ 2 [0.079], ϕ 3 [0.118], ϕ 4 [0.157]/long nozzle: ϕ 2.3 [0.091]/air amplifier nozzle: ϕ 3 [0.118]
Mass	g [oz]	194 [6.84] (main unit only)
Material	Main unit cover	PBT resin
	Lever	POM resin

Note 1: Air that is used should be clean air that contains no oil, solids, or other contaminants.

If drainage water, dust, and other contaminants get into the pulse blow air gun, they could cause defective operation.

Note 2: This product is equipped with a nozzle when shipped. Wrap sealing tape around the threads of the nozzle when assembling the product.

Note 3: This product uses grease internally.

Order codes

● Main unit

PAG- □

Nozzle diameter

- N: No nozzle
- 2: ϕ 2 mm [0.079 in.] standard nozzle
- 3: ϕ 3 mm [0.118 in.] standard nozzle
- 4: ϕ 4 mm [0.157 in.] standard nozzle



● Additional parts (individual nozzles)

· Standard nozzle

PAGZ- □

Nozzle diameter

- 2: ϕ 2 mm [0.079 in.] standard nozzle
- 3: ϕ 3 mm [0.118 in.] standard nozzle
- 4: ϕ 4 mm [0.157 in.] standard nozzle

· Air amplifier nozzle (ϕ 3 mm [0.118 in.])

PAGZ-ZN3

· Long nozzle

PAGZ-45 x □

Nozzle length

- 150: ϕ 2.3 mm [0.091 in.] long nozzle with a length of 170 mm [6.693 in.]
- 200: ϕ 2.3 mm [0.091 in.] long nozzle with a length of 220 mm [8.661 in.]

(Standard nozzle)



(Air amplifier nozzle)



(Long nozzle)



Dimensions (mm [in.])

● Main unit

PAG-□

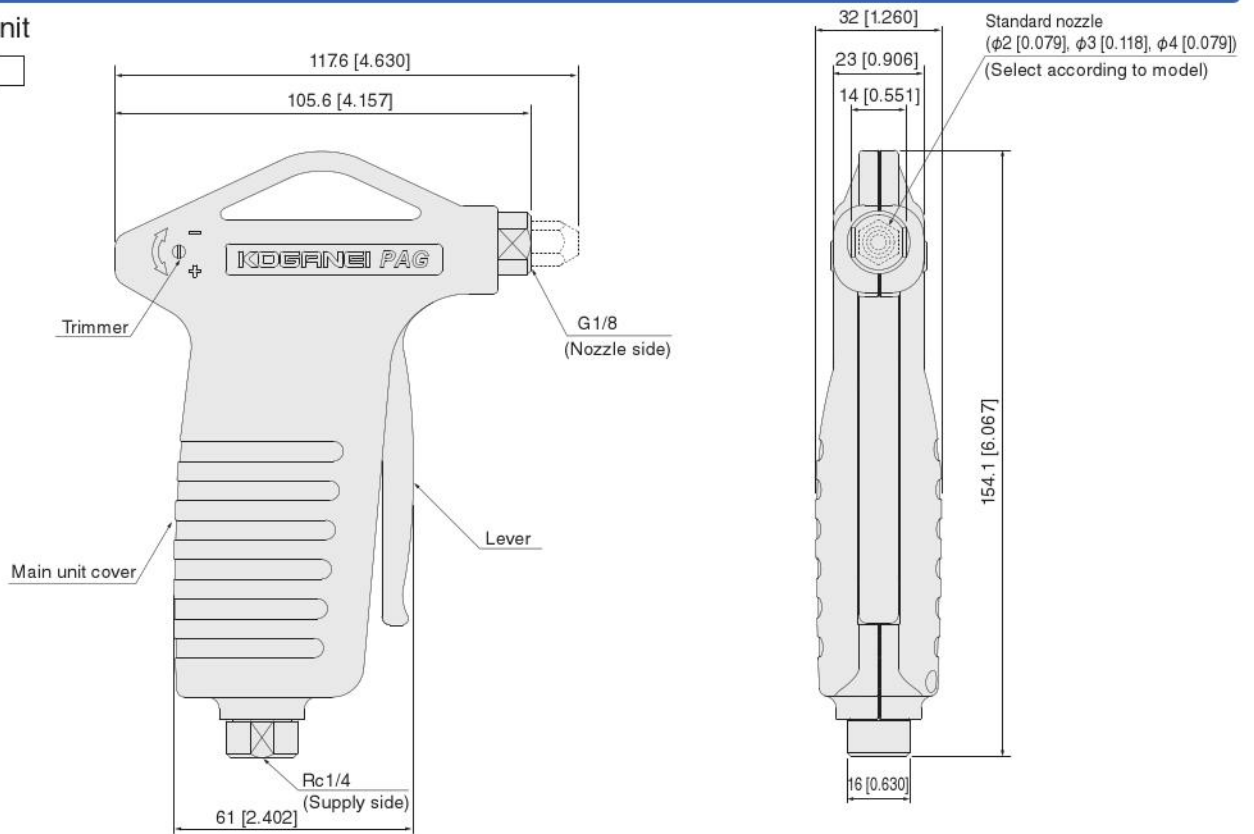

● Standard nozzle (identifier: number of slits)

PAGZ-□

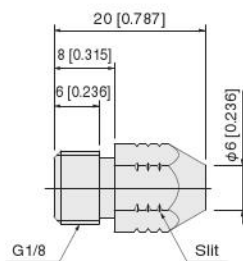
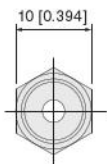

Number of slits	Nozzle diameter (mm [in.])
2	φ 2 [0.079]
3	φ 3 [0.118]
4	φ 4 [0.157]

● Air amplifier nozzle

PAGZ-ZN3

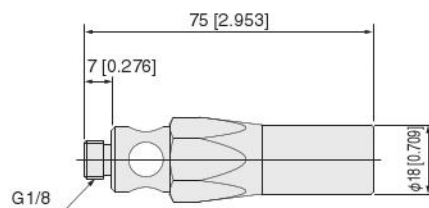
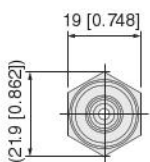

● Long nozzle

PAGZ-45 × □

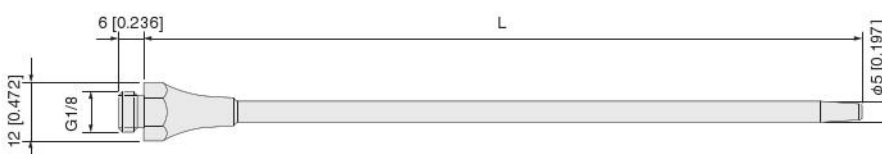

Model	L(mm [in.])
PAGZ-45x150	170 [6.693]
PAGZ-45x200	220 [8.661]

Operation principle

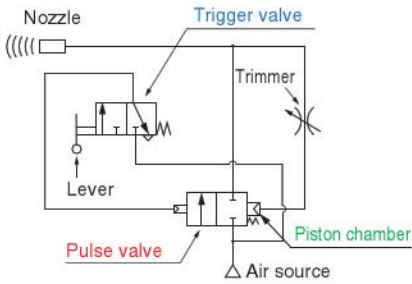

1. Pulling the lever sends a signal from the **trigger valve** to open the **pulse valve**.
 2. The **pulse valve** opens, and air is output from the nozzle.
 3. Some of the air that is output from the **pulse valve** goes through the trimmer to accumulate in the **piston chamber**.
 4. When some air has accumulated, the **pulse valve** closes so that air output from the nozzle stops and at the same time the air in the **piston chamber** is exhausted.
 5. A certain amount of air is exhausted from the **piston chamber**, the **pulse valve** opens again, and air is output from the nozzle.
- Steps 3 to 5 are then repeated. * The pulse frequency can be adjusted by using the trimmer.

Frequency adjustment method

The pulse frequency can be adjusted by rotating the frequency adjustment trimmer, as shown in the figure at right.

Use a precision flat blade screwdriver for adjustments.

Toward + (counterclockwise): Increases frequency.

Toward - (clockwise): Decreases frequency.

Note: Turning the trimmer counterclockwise raises the frequency and turning it clockwise lowers the frequency. However, turning the trimmer further than needed, after fully opening or closing it, may damage component parts.

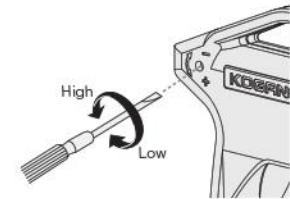

Characteristics of the frequency and flow according to the number of rotations of the trimmer (standard nozzle)

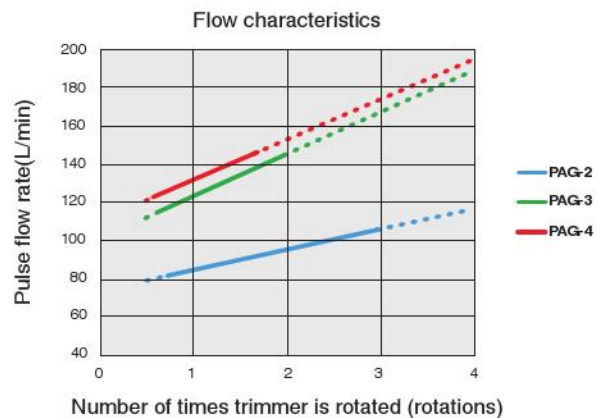
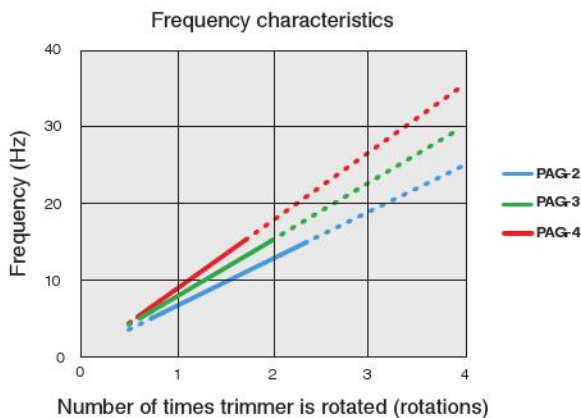

Note 1: According to our test conditions ①.

Note 2: The characteristics of the frequency and the flow vary depending on the piping conditions and the nozzle used.

Note 3: Use devices within the pulse frequency ranges (5 to 15 Hz) shown in the specification tables.

Note 4: Contact us regarding the long nozzle and air amplifier nozzle.

Test conditions ①

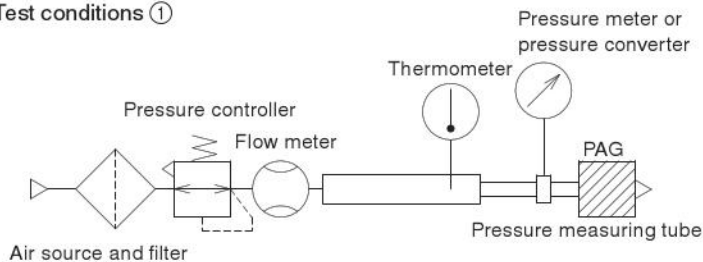

Operations according to piping conditions for pulse blow air guns (standard nozzle)

Operations may be unstable, depending on the piping conditions on the supply side. See the following table.

Model	Operating pressure	Tube ϕ 6 [0.236]			Tube ϕ 8 [0.315]		
		1000 mm [39.370 in.]	3000 mm [118.1 in.]	5000 mm [196.9 in.]	1000 mm [39.370 in.]	3000 mm [118.1 in.]	5000 mm [196.9 in.]
PAG-2	0.35 MPa [51 psi]	○	○	○	○	○	○
	0.5 MPa [73 psi]	○	○	○	○	○	○
	0.7 MPa [102 psi]	○	○	○	○	○	○
PAG-3	0.35 MPa [51 psi]	○	×	×	○	○	○
	0.5 MPa [73 psi]	○	×	×	○	○	○
	0.7 MPa [102 psi]	○	○	×	○	○	○
PAG-4	0.35 MPa [51 psi]	○	×	×	○	○	○
	0.5 MPa [73 psi]	○	×	×	○	○	○
	0.7 MPa [102 psi]	○	×	×	○	○	○

Test conditions ②

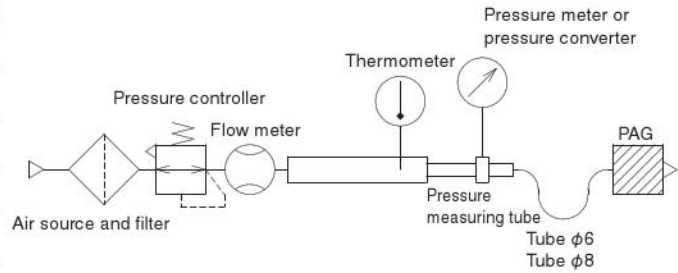

Note 1: ○ : Stable operations × : Unstable operations (according to our test conditions ②)

Note 2: Operations will be unstable if the piping conditions cause pressure drops or insufficient flow.

Note 3: Contact us regarding the long nozzle and air amplifier nozzle.

Handling precautions

Warning

- Do not point the tip of the nozzle at a person.
- Use safety glasses and earplugs because blowing air could blow objects into people's eyes or cause hearing loss.
- Install a cutoff valve on the supply side to ensure safety in case of leaks or damage.

Caution

- Air containing oil or solids cannot be used. Use cleaned air for the medium (use a filter that has a filtration rating of 40 μ m or less). If drainage water, dust, and other contaminants get into this product, they could cause defective operation.
- Pass the medium through a device, such as a freeze-type air dryer or after cooler, to lower the dew-point temperature of the medium to below the ambient temperature so condensation or frost does not occur when the products are blowing.
- Use this product within the pulse frequency ranges shown in the specification tables.
- This product operates on a balance of pressure, so supply enough pressure and volume to keep the pulse operation steady.
- Use a wrench to hold down the flat part of the product, and then tighten within the following torque ranges when piping the supply port and screwing the nozzle.

Supply side recommended tightening torque: 7 to 9 N·m
[61.957 to 79.659 in·lbf]

Nozzle side recommended tightening torque: 4.5 to 6.5 N·m
[39.830 to 57.532 in·lbf]

- Use tubing with an exterior that is not damaged. Do not allow tubing to become severely bent or twisted near the supply port. Doing so could cause air leakage.
- If you leave the product in a location where there is a lot of dust in the air or in a location where dust can be scattered, dust could get inside the product and cause defective operation.

- Do not subject the tip of the nozzle to excessive external force. Doing so could result in damage.
- Applying pressure from the nozzle side could cause defective operation or damage.
- Do not drop, step on, or dump the product. Doing so could result in damage.
- After using this product, put it on a hook or something to store it. Hooking it by the lever could cause defective operation or damage.

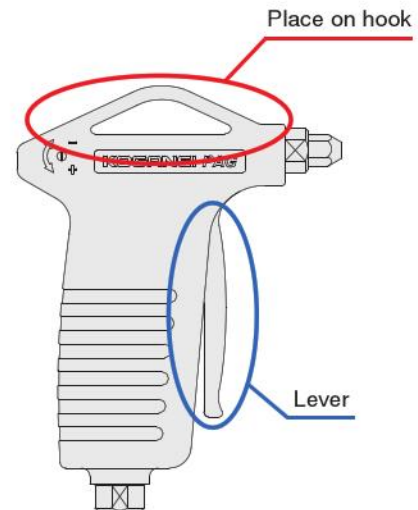

Caution

* Read "Safety precautions" on the general catalog website before using this product.

Small-size pulse blow unit

PAU-05 Series



Specifications

Item	Model and piping specifications						
	PAU-05-□						
Medium	Air						
Operating pressure range MPa [psi]	0.2 to 0.5 [29 to 73]						
Pulse frequency Hz	20 ± 5 (when 0.5 MPa [73 psi] is applied) ^{Note}						
Operating temperature range °C [°F]	5 to 50 [41 to 122]						
Material	Main unit: Aluminum alloy IN port: Aluminum alloy (for -J4 and -J6, PBT)						
Mass g [oz]	14 [0.49]	14 [0.49]	14 [0.49]	15 [0.53]	15 [0.53]	15 [0.53]	
Port size	IN port	M5×0.8	φ4 [0.157] fitting	φ6 [0.236] fitting	Rc1/8	R1/8	G1/8
	OUT port	M5×0.8	M5×0.8	Rc1/8	Rc1/8	Rc1/8	G1/8

Note 1: The frequency cannot be adjusted. This is the frequency of the pulses generated when 0.5 MPa [73 psi] is applied. For details, refer to "Characteristics of the frequency and flow according to pressure" on page ⑩.

Note 2: Air that is used should be clean air that contains no oil, solids, or other contaminants. If drainage water, dust, and other contaminants get into the pulse blow unit, they could cause defective operation.

Note 3: This product uses grease internally.

Dimensions (mm [in.])

● PAU-05-M5

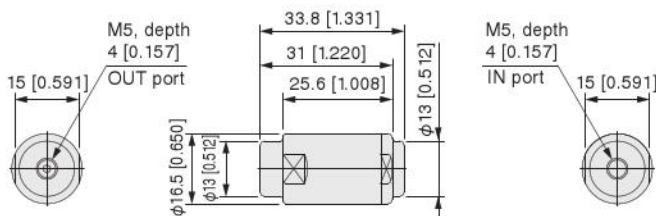

● PAU-05-01A

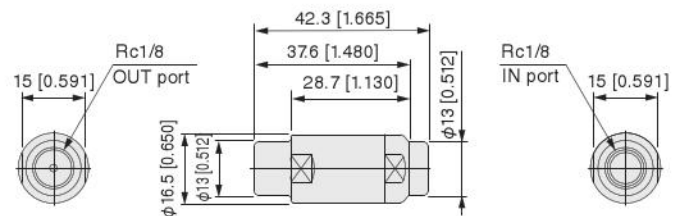

● PAU-05-J4

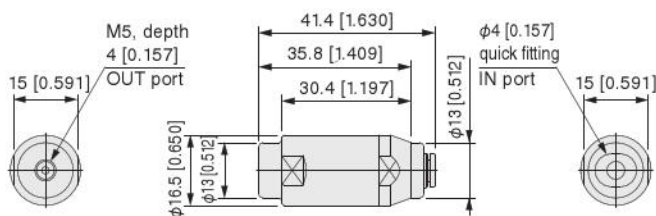

● PAU-05-01B

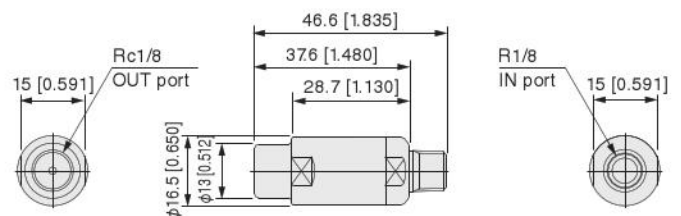

● PAU-05-J6

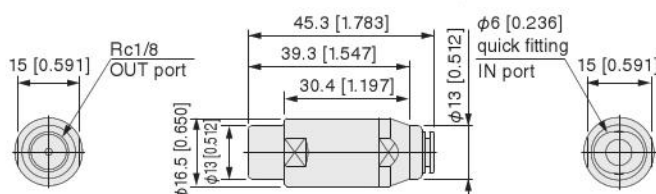

● PAU-05-01C

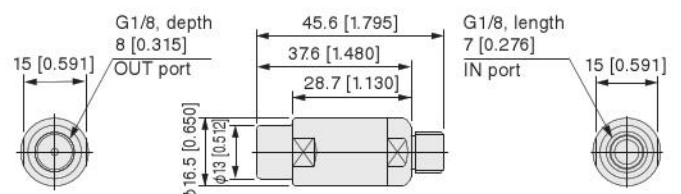

Order codes

● Main unit

PAU-05- □

Port size













- M5** : IN piping, M5 (internal thread) OUT piping, M5 (internal thread)
- J4** : IN piping, φ 4 [0.157] quick fitting OUT piping, M5 (internal thread)
- J6** : IN piping, φ 6 [0.236] quick fitting OUT piping, Rc1/8
- 01A** : IN piping, Rc1/8 OUT piping, Rc1/8
- 01B** : IN piping, R1/8 OUT piping, Rc1/8
- 01C** : IN piping, G1/8 (external thread) OUT piping, G1/8 (internal thread)

Remarks: No mounting brackets for securing are not supplied. If you want to secure the product, supply a mounting bracket for securing by yourself.

<<Recommended mounting bracket>>

- Akagi Co., Ltd. Resin band (color: light gray) CLIC standard
Model number: A10530-0284

Appearance of IN piping and OUT piping

Model	PAU-05-M5	PAU-05-J4	PAU-05-J6	PAU-05-01A	PAU-05-01B	PAU-05-01C
Piping						
IN piping						
Port size	M5 (internal thread)	ϕ 4 [0.157] quick fitting	ϕ 6 [0.236] quick fitting	Rc1/8 (internal thread)	R1/8 (external thread)	G1/8 (external thread)
OUT piping						
Port size	M5 (internal thread)	M5 (internal thread)	Rc1/8 (internal thread)	Rc1/8 (internal thread)	Rc1/8 (internal thread)	G1/8 (internal thread)

Characteristics of the frequency and flow according to pressure

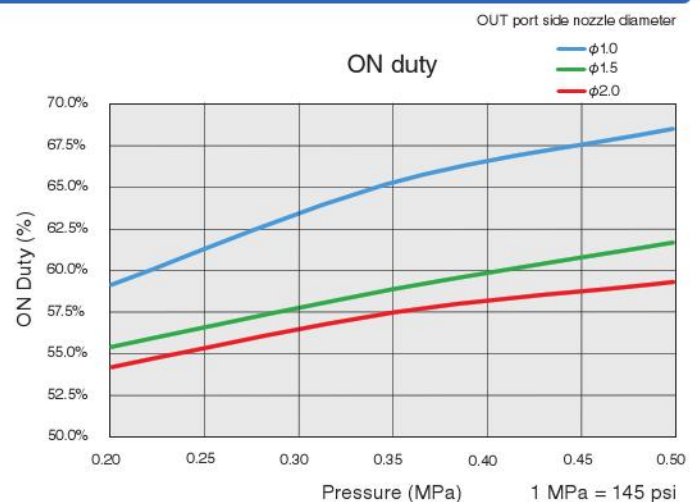
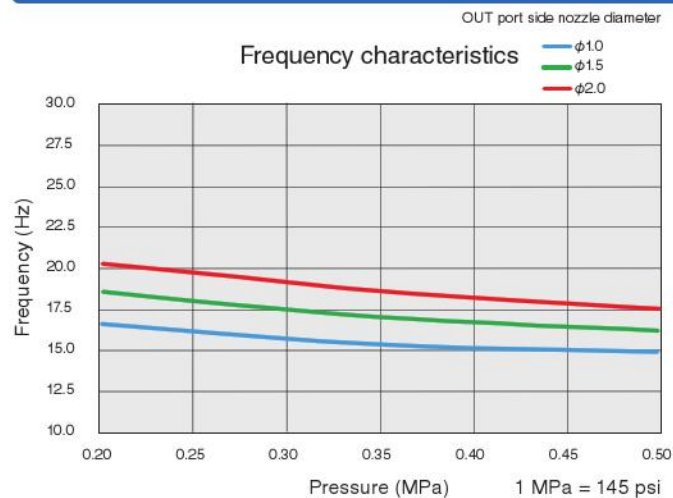

<<Interpretation of the above graphs>>

When the pressure is 0.35 MPa [51 psi] and the nozzle diameter is ϕ 2 [0.079], the frequency is 19 Hz and the ON duty is 57.5%. The air reduction at this time is 42.5%.

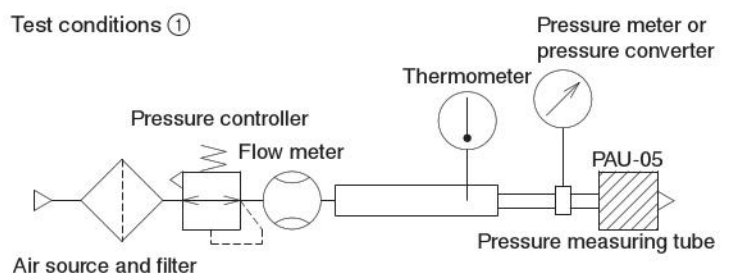
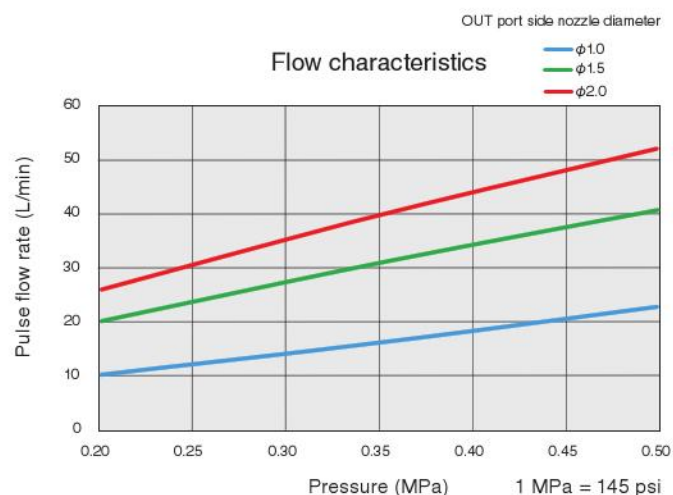

Note 1: According to our test conditions ①.

Note 2: The characteristics of the frequency and the flow vary depending on the piping conditions and the nozzle used.

Operations according to piping conditions for pulse blow units

Operations may be unstable, depending on the piping conditions on the IN port side. See the following table.

Nozzle diameter	Operating pressure	Tube ϕ 4 [0.157]			Tube ϕ 6 [0.236]		
		1000 mm [39.370 in.]	3000 mm [118.1 in.]	5000 mm [196.9 in.]	1000 mm [39.370 in.]	3000 mm [118.1 in.]	5000 mm [196.9 in.]
ϕ 1.0 [0.039]	0.20 MPa [29 psi]	○	○	○	○	○	○
	0.35 MPa [51 psi]	○	○	○	○	○	○
	0.50 MPa [73 psi]	○	○	○	○	○	○
ϕ 1.5 [0.059]	0.20 MPa [29 psi]	○	○	○	○	○	○
	0.35 MPa [51 psi]	○	○	○	○	○	○
	0.50 MPa [73 psi]	○	○	○	○	○	○
ϕ 2.0 [0.079]	0.20 MPa [29 psi]	○	○	×	○	○	○
	0.35 MPa [51 psi]	○	○	○	○	○	○
	0.50 MPa [73 psi]	○	○	○	○	○	○

Test conditions ②

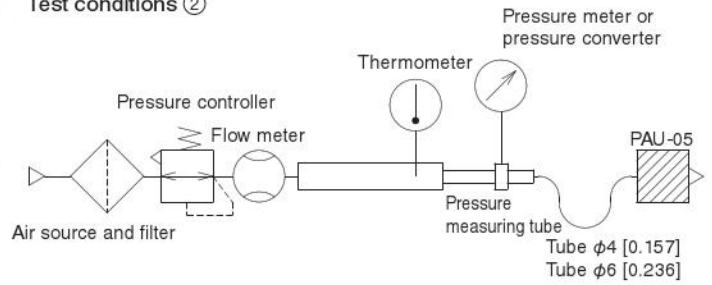

Note 1: ○ : Stable operations × : Unstable operations (according to our test conditions ②)

Note 2: Operations will be unstable if the piping conditions cause pressure drops or insufficient flow.

Handling precautions

Warning

- Use safety glasses and earplugs because blowing air could blow objects into people's eyes or cause hearing loss.
- Install a cutoff valve on the IN port side to ensure safety in case of leaks or damage.

Caution

- Air containing oil or solids cannot be used. Use cleaned air for the medium (use a filter that has a filtration rating of 40 μ m or less). If drainage water, dust, and other contaminants get into this product, they could cause defective operation.
- Pass the medium through a device, such as a freeze-type air dryer or after cooler, to lower the dew-point temperature of the medium to below the ambient temperature so condensation or frost does not occur when the products are blowing.
- This product operates on a balance of pressure, so supply enough pressure and volume to keep the pulse operation steady.
- It is recommended to make a one-to-one connection between this product and an air blow gun or a nozzle.
- If you want to install this product apart from the cutoff valve and other parts, make sure that the distance does not exceed 3 m [9.840 ft] on the primary side if using a ϕ 4 [0.157]×2.5 tube. On the secondary side, it is recommended to connect a nozzle directly.



Caution

* Read "Safety precautions" on the general catalog website before using this product.

- The piping work is as follows: Use a wrench to hold down the "IN port side flat part" when piping the IN port and the "OUT port side flat part" when piping the OUT port, and then tighten within the following torque range. Performing the piping work by using other flat parts could cause damage to the product.

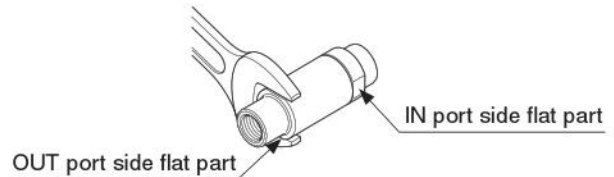

Screw size	M5×0.8	Rc1/8, R1/8, G1/8
Recommended tightening torque N·m [in·lbf]	1 to 1.5 [8.851 to 13.277]	4.5 to 6.5 [39.830 to 57.532]

- Use tubing with an exterior that is not damaged. Do not allow tubing to become severely bent or twisted near the IN port. Doing so could cause air leakage.
- Do not mount this product on the secondary side of an electrostatic eliminator. Doing so will reduce the neutralization function of air blowing considerably.

Pulse blow unit

PAU Series



Specifications

Item	Model	PAU
Medium		Air
Operating pressure range	MPa [psi]	0.35 to 0.7 [51 to 102]
Pulse frequency	Hz	5 to 15
Operating temperature range	°C [°F]	5 to 50 [41 to 122]
Mass	g [oz]	73 [2.57]
Material	Main unit	Aluminum alloy
	Bracket	Mild steel (nickel plated)
Port size		IN: Rc1/4
		OUT: G1/4

Note 1: Air that is used should be clean air that contains no oil, solids, or other contaminants.
If drainage water, dust, and other contaminants get into the pulse blow unit, they could cause defective operation.

Note 2: This product uses grease internally.

Order codes

Main unit

PAU-

Bracket

Blank: No bracket

21: With bracket (attached)

Additional parts (sold separately)

Bracket (Two M3 screws attached)

PAUZ-21

* The projection-type trimmer type is also available.

PAU- **-3W**

Bracket

Blank: No bracket

21: With bracket (attached)

Dimensions (mm [in.])

Main unit PAU

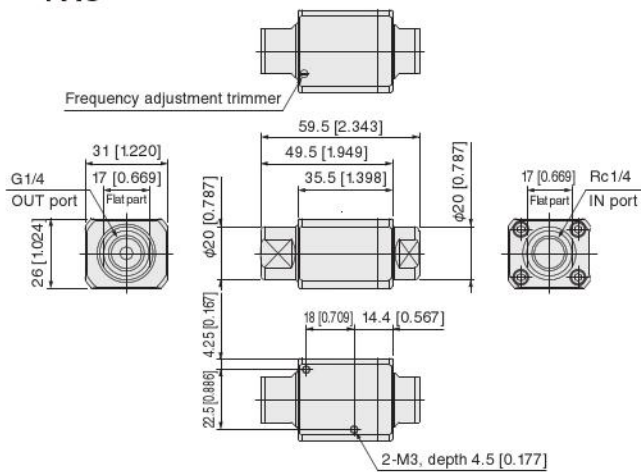

PAU- -3W

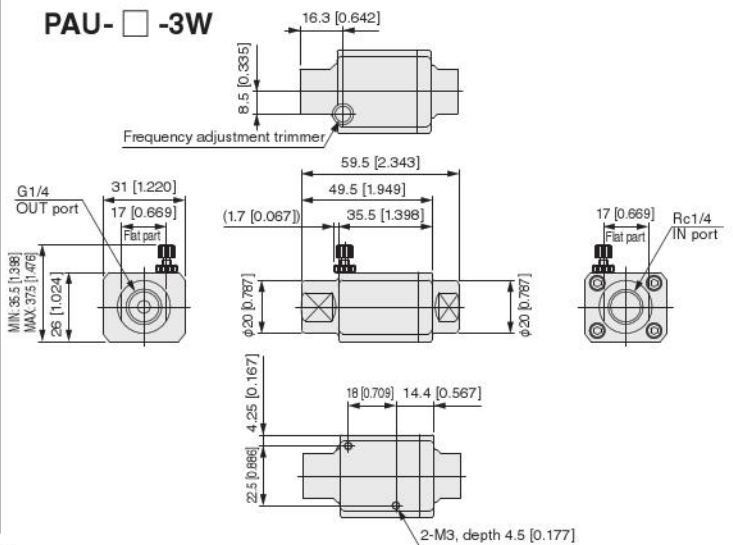

Additional parts (sold separately)

Bracket PAUZ-21

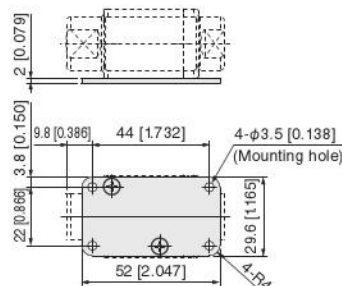

Frequency adjustment method

The pulse frequency can be adjusted by rotating the frequency adjustment trimmer, as shown in the figure at right.

Use a precision flat blade screwdriver for adjustments.

Turn it in the + direction (counterclockwise direction) to increase the frequency.

Turn it in the - direction (clockwise direction) to decrease the frequency.

Note: Turning the trimmer counterclockwise increases the frequency and turning it clockwise decreases the frequency. Turning the trimmer more than necessary after turning it fully clockwise or counterclockwise may damage the components.

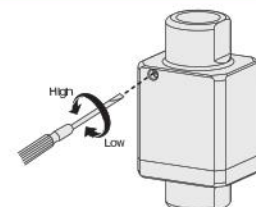

Characteristics of the frequency and flow according to the number of rotations of the trimmer

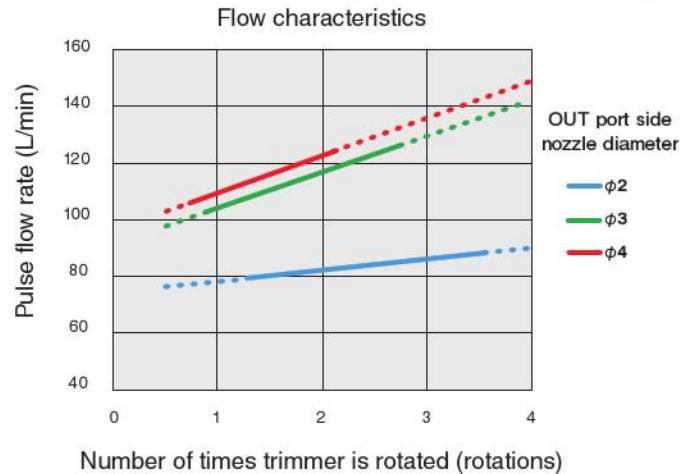
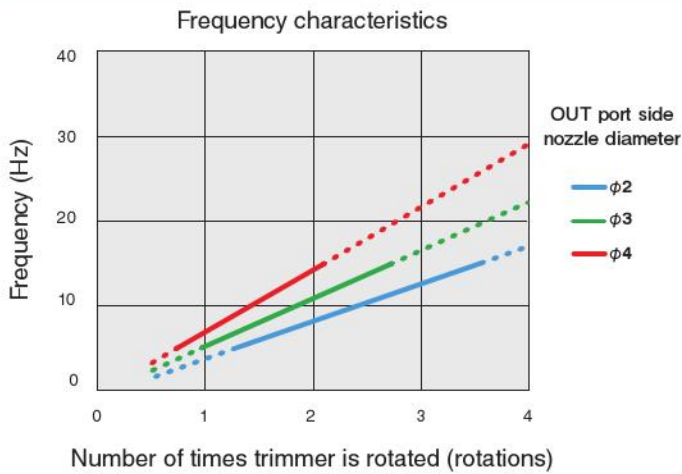

- Note 1: According to our test conditions ①.
- Note 2: The characteristics of the frequency and the flow vary depending on the piping conditions and the nozzle used.
- Note 3: Use this product within the pulse frequency ranges shown in the specification tables (5 to 15 Hz).

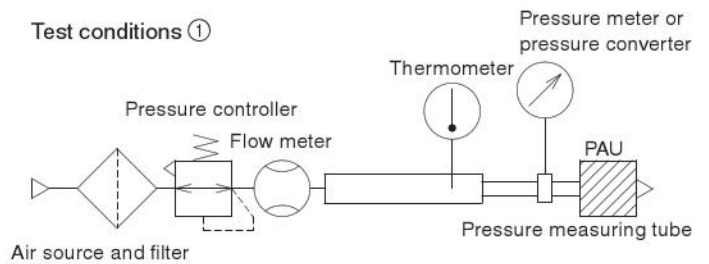

Operations according to piping conditions for pulse blow units

Operations may be unstable, depending on the piping conditions on the IN port side. See the following table.

Nozzle diameter	Operating pressure	Tube φ 6 [0.236]			Tube φ 8 [0.315]		
		1000 mm [39.370 in.]	3000 mm [118.1 in.]	5000 mm [196.9 in.]	1000 mm [39.370 in.]	3000 mm [118.1 in.]	5000 mm [196.9 in.]
φ 2 [0.079]	0.35 MPa [51 psi]	○	○	○	○	○	○
	0.5 MPa [73 psi]	○	○	○	○	○	○
	0.7 MPa [102 psi]	○	○	○	○	○	○
φ 3 [0.118]	0.35 MPa [51 psi]	○	○	×	○	○	○
	0.5 MPa [73 psi]	○	○	○	○	○	○
	0.7 MPa [102 psi]	○	○	○	○	○	○
φ 4 [0.157]	0.35 MPa [51 psi]	○	×	×	○	○	○
	0.5 MPa [73 psi]	○	×	×	○	○	○
	0.7 MPa [102 psi]	○	×	×	○	○	○

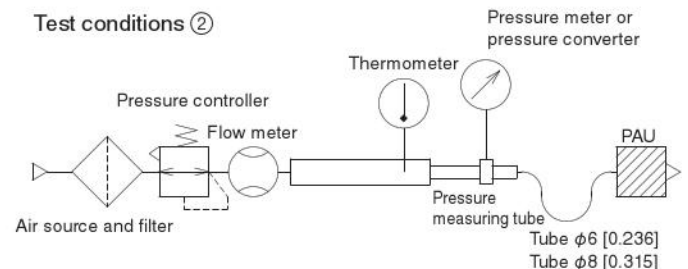

- Note 1: ○ : Stable operations x: Unstable operations (according to our test conditions ②)
- Note 2: Operations will be unstable if the piping conditions cause pressure drops or insufficient flow.

Handling precautions

Warning

- Use safety glasses and earplugs because blowing air could blow objects into people's eyes or cause hearing loss.
- Install a cutoff valve on the IN port side to ensure safety in case of leaks or damage.

Caution

- Air containing oil or solids cannot be used. Use cleaned air for the medium (use a filter that has a filtration rating of 40 μm or less). If drainage water, dust, and other contaminants get into this product, they could cause defective operation.
- Pass the medium through a device, such as a freeze-type air dryer or after cooler, to lower the dew-point temperature of the medium to below the ambient temperature so condensation or frost does not occur when the products are blowing.
- Use this product within the pulse frequency ranges shown in the specification tables.

- This product operates on a balance of pressure, so supply enough pressure and volume to keep the pulse operation steady.
- It is recommended to make a one-to-one connection between this product and the air blow gun or a nozzle.
- If you want to install this product apart from the air blow gun or nozzle, a φ8 [0.315]×6 tube and a distance not exceeding 2 m [6.560 ft] are recommended.
- Use a wrench to hold down the flat part of the product, and then tighten within the following torque range when piping the IN port and the OUT port.

Recommended tightening torque		PAU
N·m [in·lb]		7 to 9 [61.957 to 79.659]

- Use tubing with an exterior that is not damaged. Do not allow tubing to become severely bent or twisted near the IN port. Doing so could cause air leakage.
- Do not mount this product on the secondary side of an electrostatic eliminator. Doing so will reduce the neutralization function of air blowing considerably.

Caution * Read "Safety precautions" on the general catalog website before using this product.

Pulse blow unit

PAU Series Large flow rate type



Specifications

Item		Model	
		PAU-30-02 (-25)	PAU-30-03 (-25)
Medium		Air	
Operating pressure range MPa [psi]		0.35 to 0.7 [51 to 102]	
Pulse frequency Hz		5 to 15	
Operating temperature range °C [°F]		5 to 50 [41 to 122]	
Mass g [oz]		105 [3.70] (113 [3.99])	100 [3.53] (108 [3.81])
Material		Aluminum alloy	
Port size	IN	Rc1/4	Rc3/8
	OUT		

Note 1: Air that is used should be clean air that contains no oil, solids, or other contaminants.

If drainage water, dust, and other contaminants get into the pulse blow unit, they could cause defective operation.

Note 2: This product uses grease internally.

Order codes

● Main unit

PAU-30- -

Direct mounting

Blank: No mounting holes or brackets

25: Direct mounting

Port size

02: Rc1/4 (for both IN and OUT)

03: Rc3/8 (for both IN and OUT)

* The projection-type trimmer type is also available.

PAU-30- **-3W**

PAU-30- **-25-3W**

Dimensions (mm [in.])

● Main unit

PAU-30-

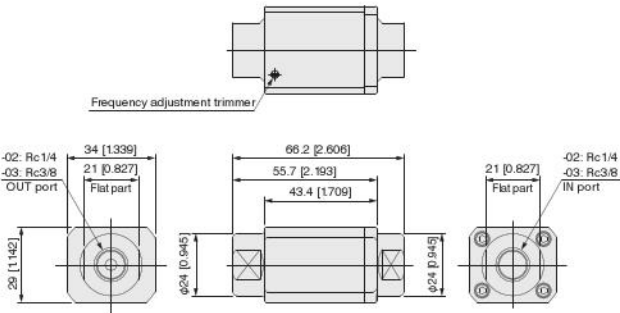

PAU-30- **-3W**

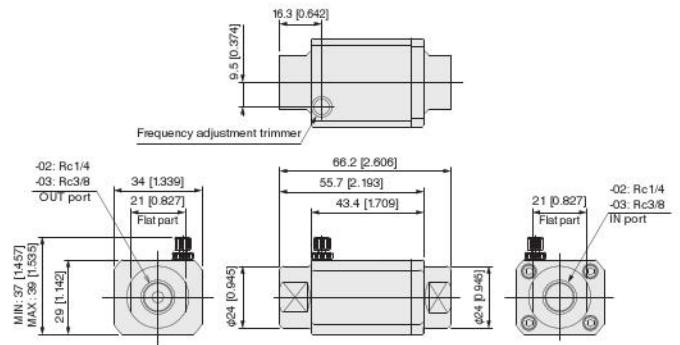

PAU-30- **-25**

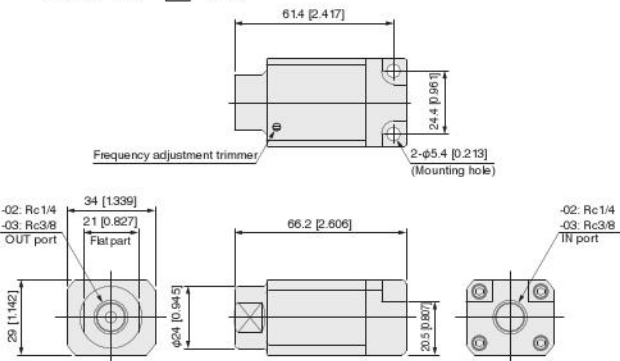

PAU-30- **-25-3W**

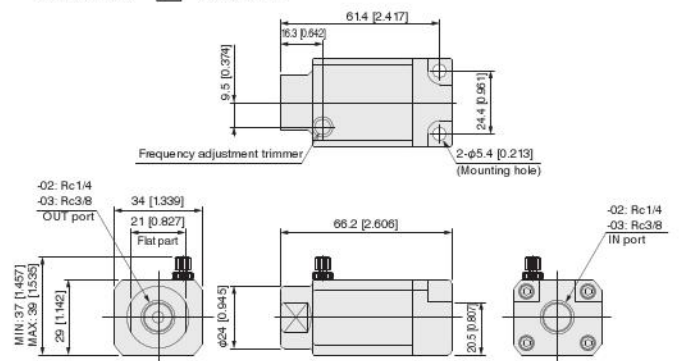

Characteristics of the frequency and flow according to the number of rotations of the trimmer

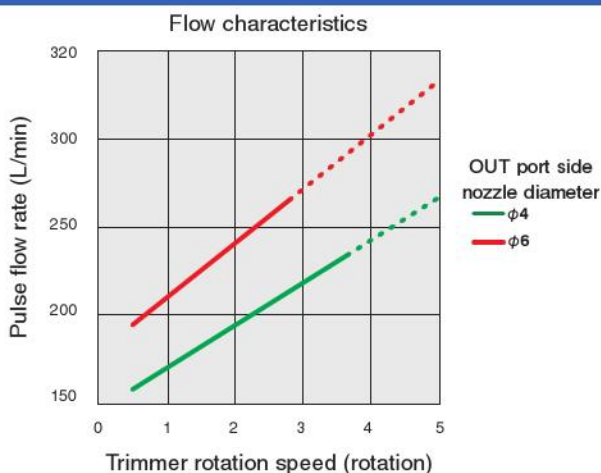
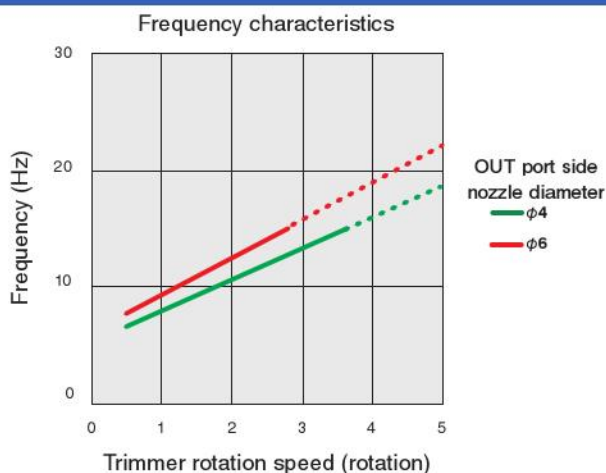

- Note 1: According to our test conditions ①.
 Note 2: The characteristics of the frequency and the flow vary depending on the piping conditions and the nozzle used.
 Note 3: Use devices within the pulse frequency ranges (5 to 15 Hz) shown in the specification tables.

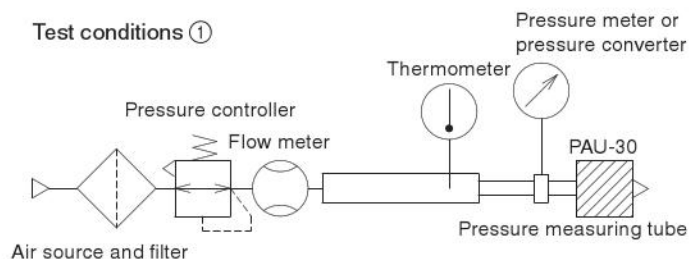

Operations according to piping conditions for pulse blow units

Operations may be unstable, depending on the piping conditions on the IN port side. See the following table.

Nozzle diameter	Operating pressure	Tube φ 8 [0.315]		Tube φ 10 [0.394]		Tube φ 12 [0.472]	
		1000 mm [39.370 in.]	5000 mm [196.9 in.]	1000 mm [39.370 in.]	5000 mm [196.9 in.]	1000 mm [39.370 in.]	5000 mm [196.9 in.]
φ 4 [0.157]	0.35 MPa [51 psi]	○	△	○	○	○	○
	0.5 MPa [73 psi]	○	△	○	○	○	○
	0.7 MPa [102 psi]	○	△	○	○	○	○
φ 6 [0.236]	0.35 MPa [51 psi]	○	△	○	△	○	○
	0.5 MPa [73 psi]	○	△	○	△	○	○
	0.7 MPa [102 psi]	○	△	○	△	○	○

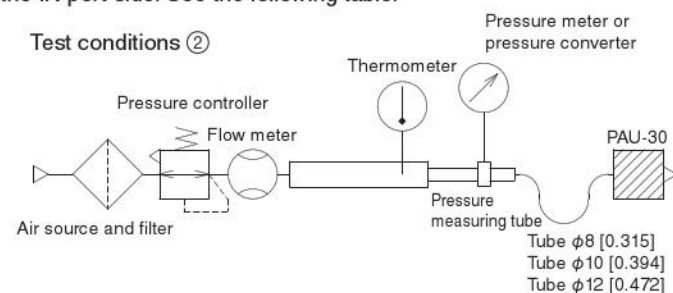

- Note 1: ○ : Stable operations △ : Minimum frequency of 5 to 10 Hz (according to our test conditions ②)
 Note 2: Operations will be unstable if the piping conditions cause pressure drops or insufficient flow.

Handling precautions

Warning

- Use safety glasses and earplugs because blowing air could blow objects into people's eyes or cause hearing loss.
- Install a cutoff valve on the IN port side to ensure safety in case of leaks or damage.

Caution

- Air containing oil or solids cannot be used. Use cleaned air for the medium (use a filter that has a filtration rating of 40 μm or less). If drainage water, dust, and other contaminants get into this product, they could cause defective operation.
- Pass the medium through a device, such as a freeze-type air dryer or after cooler, to lower the dew-point temperature of the medium to below the ambient temperature so condensation or frost does not occur when the products are blowing.
- Use this product within the pulse frequency ranges shown in the specification tables.



Caution

* Read "Safety precautions" on the general catalog website before using this product.

- This product operates on a balance of pressure, so supply enough pressure and volume to keep the pulse operation steady.
- It is recommended to make a one-to-one connection between this product and the air blow gun or a nozzle.
- If you want to install this product apart from the air blow gun or nozzle, a φ8 [0.315]×6 tube and a distance not exceeding 2 m [6.560 ft] are recommended.
- For piping to the IN port or the OUT port, tighten within the torque range below.

	PAU-30-02 (-25)	PAU-30-03 (-25)
Recommended tightening torque N·m [in·lbf]	7 to 9 [61.957 to 79.659]	12.5 to 14.5 [110.6 to 128.3]

* Piping for both IN port side and OUT port side

- Use tubing with an exterior that is not damaged. Do not allow tubing to become severely bent or twisted near the IN port. Doing so could cause air leakage.
- Do not mount this product on the secondary side of an electrostatic eliminator. Doing so will reduce the neutralization function of air blowing considerably.

Special support

Common to all products in the PAU Series

As of May 2022

Support that can be provided	PAU-05	PAU	PAU-30
Vaseline type	○	○	○
H1 grease type	○	○	○
Projection-type trimmer	-	○	○
Degrease type (Grease wiping-equivalent/fluorine type quick-drying lubricant application)	○	○	○
IN/OUT port Rc1/8	Standard type	○	○
Low-pressure type, OUT port Rc1/4	-	○	○

○ : Support can be provided -: Support cannot be provided

For the IN port and the OUT port, we can also offer the parallel pipe thread G type and the National Pipe Thread (NPT) type.
For details, contact Koganei.

Limited Warranty

KOGANEI CORP. warrants its products to be free from defects in material and workmanship subject to the following provisions.

Warranty Period The warranty period is 180 days from the date of delivery.

Koganei Responsibility If a defect in material or workmanship is found during the warranty period, KOGANEI CORP. will replace any part proved defective under normal use free of charge and will provide the service necessary to replace such a part.

Limitations ● This warranty is in lieu of all other warranties, expressed or implied, and is limited to the original cost of the product and shall not include any transportation fee, the cost of installation or any liability for direct, indirect or consequential damage or delay resulting from the defects.

● KOGANEI CORP. shall in no way be liable or responsible for injuries or damage to persons or property arising out of the use or operation of the manufacturer's product.

● This warranty shall be void if the engineered safety devices are removed, made inoperative or not periodically checked for proper functioning.

● Any operation beyond the rated capacity, any improper use or application, or any improper installation of the product, or any substitution upon it with parts not furnished or approved by KOGANEI CORP., shall void this warranty.

● This warranty covers only such items supplied by KOGANEI CORP. The products of other manufacturers are covered only by such warranties made by those original manufacturers, even though such items may have been included as the components.

The specifications are subject to change without notice.

URL <http://www.koganei.co.jp>

E-mail: overseas@koganei.co.jp



KOGANEI CORPORATION

OVERSEAS DEPARTMENT

3-11-28, Midori-cho, Koganei City, Tokyo 184-8533, Japan
Tel: 81-42-383-7271 Fax: 81-42-383-7276

KOGANEI INTERNATIONAL AMERICA, INC.

48860 Milmont Drive, suite 108C, Fremont, California 94538
Tel : 1-510-744-1626 Fax : 1-510-744-1676

SHANGHAI KOGANEI INTERNATIONAL TRADING CORPORATION

Room 2606-2607, Tongda Venture Building No.1, Lane 600, Tianshan Road,
Shanghai, 200051, China
Tel: 86-21-6145-7313 Fax: 86-21-6145-7323

TAIWAN KOGANEI TRADING CO., LTD.

Rm. 2, 13F., No88, Sec. 2, Zhongxiao E. Rd., Zhongzheng Dist., Taipei City 100,
Taiwan (ROC)
Tel: 886-2-2393-2717 Fax: 886-2-2393-2719

KOGANEI KOREA CO., LTD.

6F-601, Tower Bldg., 1005, Yeongde0-dong, Giheung-gu, Yongin-si, Gyeonggi-do,
446-908, Korea
Tel: 82-31-246-0414 Fax: 82-31-246-0415

KOGANEI (THAILAND) CO., LTD.

555 Rasa Tower 1, 12th Floor, Unit 1202 and 1207, Phaholyothin Road,
Chatuchak, Chatuchak, Bangkok 10900 Thailand
Tel: 66-2-937-4250 Fax: 66-2-937-4254

KOGANEI AUTOMATION (MALAYSIA) SDN.BHD.

Suite 29-2, Level 29, Menara 1MK, No.1, Jalan Kiara, Mont Kiara
50480, Kuala Lumpur, Malaysia
Tel: 60-12-537-7086

KOGANEI ASIA PTE. LTD.

69 Ubi Road 1, #05-18 Oxley Bizhub, Singapore 408731
Tel: 65-6293-4512 Fax: 65-6293-4513