

Product Range

Features (Diaphragm Type)

● **Reliable operation**

Uses diaphragm construction that enables quick and sharp switching peculiar to this type. The valve seat is also reliable.

● **Trouble free structure**

An extremely simple structure and a poppet-type seat method ensures freedom from galling, even if a certain amount of dust intrudes inside.

Moreover, it will not stick even after being left unused for long periods.

● **Can be used without lubrication.**

No sliding parts, and lubrication is unnecessary, and no breakdown problems due to inadequate lubrication.

● **Any mounting direction is acceptable.**

This structure ensures operations without a hitch, no matter what the mounting direction is.

● **Compact and lightweight**

An original compact design, and a light aluminum alloy body.

■ Manual valves (push button type)



- Using nuts enables compact installation on panels (125P, 125HO types).
- Can also hold the pressed-down condition (125HO type).
- A vacuum valve with a non-leakage structure is also available.

Applications

- ON/OFF for pilot air
- Operation for single acting air cylinders and air grippers
- Filling or exhausting of air tank
- ON/OFF for air supply (125HO)
- ON/OFF for air jet and air blowing

■ Foot valves



- A holding mechanism maintains the unit in an operating condition, which can then be released by pushing a foot-operated latch located back of the pedal (250FL, 250-4FL, 25034FL).

Applications

- Operation for double acting air cylinders and air grippers
- ON/OFF for pilot air (Double air-piloted valve)

**Manual valves
(lever-operated type 2-, 3-port)**

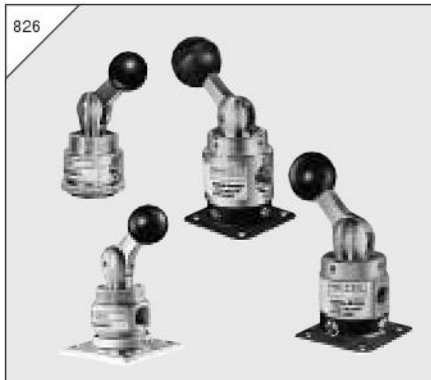

- Using nuts enables compact installation on panels (125V).
- A vacuum valve with a non-leakage structure is also available.

Applications

- ON/OFF for pilot air
- Operation for single acting air cylinders and air gripper
- Filling or exhausting of air tank
- ON/OFF for air supply
- ON/OFF for air jet and air blowing

**Manual valves
(lever-operated type 3-position, 5-port)**



- Operation of double acting air cylinders and air grippers (In the neutral position, the air cylinder and air gripper are in the free condition, and can be operated manually).
- A vacuum valve with a non-leakage structure is also available.

Applications

- Switching of pilot air
- Switching of air supply

Manual valves



- Sliding valve construction, and manually switched 4-port valve.
- Rotary type (swing lever) for reliable switching.

Applications

- For switching air cylinders

Mechanical valves (ball-cam type)



- Using nuts enables compact installation on panels (125B).
- A vacuum valve with a non-leakage structure is also available.

Applications

- ON/OFF for pilot air
- Operation for single acting air cylinders and air gripper
- Filling or exhausting of air tank
- ON/OFF for air jet and air blowing

Mechanical valves (roller-cam type)

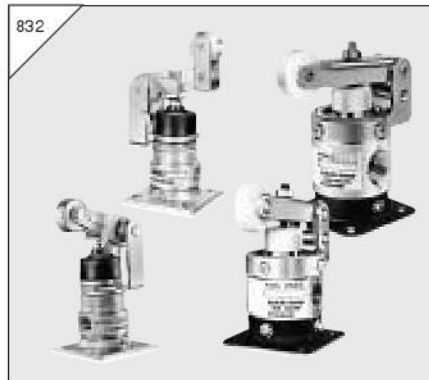

- Sturdy structure capable of withstanding harsh operation.
- Offers smooth pilot air switching.

Applications

- ON/OFF for pilot air
- Operation for single acting air cylinders and air gripper
- Filling or exhausting of air tank
- ON/OFF for air jet

Micro valves

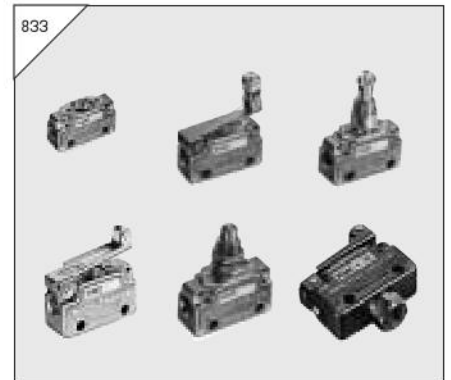

- Both normally closed and normally open types are available for 2-port and 3-port valves, to ensure applications of using every type of pneumatic signal.
- Virtually no change in operational force from low to high pressure range.
- No neutral position means smooth switching between the A port and R port.

Applications

- Confirms operations in pneumatic control circuits.
- Switches air pressure signals.
- Operation of air cylinder
- Filling or exhausting of air tank

MANUAL VALVES

Lever-operated Type 3-position, 5-port

Symbol

5-port (Exhaust center)

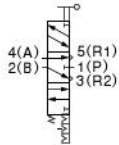

250-4H, 2503-4H

Specifications

Item	Basic model	250-4H	2503-4H
Port size		Rc1/4	Rc3/8
Media		Air	
Operating pressure range	MPa [kgf/cm ²] [psi.]	0.1~0.9 [0~9.2] [15~131]	
Proof pressure	MPa [kgf/cm ²] [psi.]	1.35 [13.8] [196]	
Operating temperature range (atmosphere and media)	°C [°F]	5~60 [41~140]	
Effective area	mm ²	15	
Flow coefficient	Cv	0.76	
Valve stroke	mm [in.]	1.6 [0.063]	
Lubrication		Not required	
Mass	kg [lb.]	0.6 [1.3]	

Order Code



Basic model

Basic model	Port size
250-4H	Rc1/4
2503-4H	Rc3/8

Examples:
250-4H
2503-4H

Flow Rate

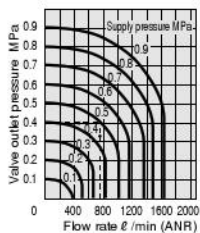

1MPa = 145psi., 1 l / min = 0.0353ft³/min.

How to read the graph

When the supply pressure is 0.5MPa [73psi.] and the flow rate is 740 l / min [26.1ft³/min.] (ANR), the valve outlet pressure becomes 0.4MPa [58psi.].

Lever Position and Air Path

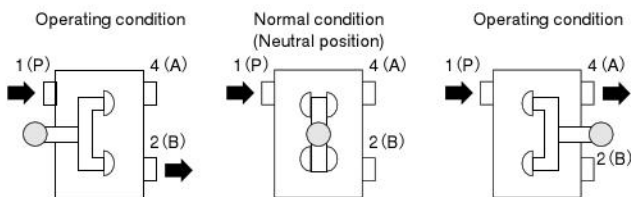

Inner Construction, Major Parts and Materials

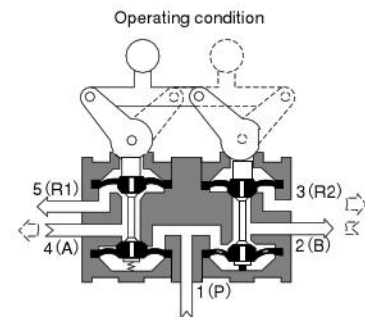
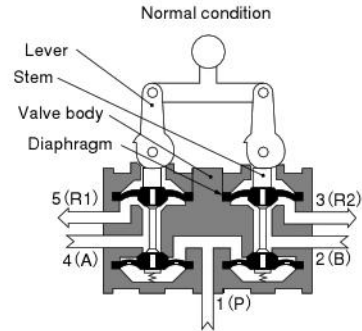

Parts	Materials
Body	Aluminum alloy (anodized)
Stem	Brass
Diaphragm	Synthetic rubber

Dimensions (mm)

