

Fluid Control Equipment Proportional Control Valve

KFPV050 • KFPV300 Series



Koganei brand

All products are **RoHS**
directive compliant

**Gas, liquid
media adjusters**



**Large proportional
control valve lineup!**

Three Advanced Features!

- Stepless variable control of gases and liquids
- High-precision hysteresis (1/2 that of previous models)
- Initial setting possible without external input

Fluid Control Equipment

Proportional Control Valves KFPV050 · KFPV300 Series

 Environmentally friendly **RoHS** compliant product!

In combination with a special controller, input signal size can be changed, which enables seamless flow rate adjustment and highly accurate control of air, liquids, and other types of media.

- Enabling a seamless control of gas and liquid flow rates, it is a single unit with dual functions.
 - High accuracy, high quality, and high response.
- In combination with the KFPC1 controller, it provides the following high-level specifications (under Koganei test conditions): repeatability 2% F.S. or less, response accuracy: 2% F.S. or less, low hysteresis: 5%F.S. or less.

Proportional Control Valves **NEW** KFPV300 Series

Rc3/8, Rc1/2^{Note} Direct Acting 2-port Valve, Plunger type
 Note: Piping connection port diameter depends on orifice diameter.

Large flow rate!

Air flow rate control that is approximately 6 times^{Note} greater than that of the KFPV050 series.
 Note: Under Koganei measurement conditions.



(Body material: SCS13 (SUS304 equivalent))

Proportional Control Valves KFPV050 Series

Rc1/4 Direct Acting 2-port Valve, Plunger type



(Body material: SUS304)

(Body material: Brass)

Adjustable wiring
 Greater freedom in wiring and design makes it easier to respond to equipment and device mounting conditions.

• Wiring lead-out can be up, down, left, or right in 90° increments.



KFPV050 series



KFPV300 series

• Solenoid direction can also be changed.



KFPV050 series



KFPV300 series

90° increments
360°

CAUTION Read the safety precautions on page 3 before using this product.

Proportional control valve controller KFPC1

- With a circuit that supports default settings! Initialization can be performed without external input.
- Highly reliable controller
 - Reference input signal 4 to 20 mA, 0 to 10V.
 - In order to mitigate wide fluctuations of the reference input signal, the ramp response time can be adjusted within a range of 0 to 10 seconds.
 - Monitor signal for display of settings and solenoid flow rate values.
 - Zero point switch off function completely seals the valve.
 - Built-in temperature compensation circuit.
 - Two potentiometers set valve opening points and fully open flow rate values to match usage conditions.
 - LED monitor.



INDEX

- Safety precautions 3
- Handling instructions and precautions 5
- Proportional control valve KFPV050 series
- Display symbols and specifications 7
- Inner construction diagrams, major parts and materials, order codes 8
- Dimensions 9
- Proportional control valve KFPV300 series
- Display symbols and specifications 10
- Inner construction diagrams, major parts and materials, precaution symbols 11
- Dimensions 12
- Proportional control valve controller KFPC1
- Specifications, nomenclature and functions, order codes 13
- Dimensions 14
- Flow rate conversion graphs 15
- Glossary 17
- Introduction to related catalogs 19

Example connection circuit configuration

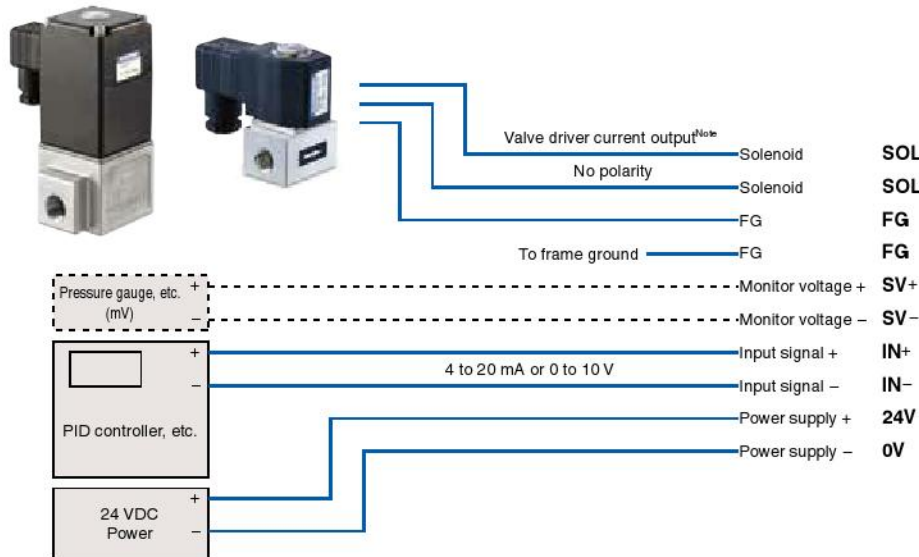

Note: For information about valve driver current values (reference values), refer to the instruction manual that comes with the controller.



Proportional control valve controller KFPC1

Example of use

Water flow rate control

The KFPV050 series and KFPV300 series allows seamless control of the flow rate in accordance with changes in the input signal size.

Now a single control valve can perform multiple-level flow control that normally requires multiple ON/OFF type solenoid valves.



2-liquid mixture

Mixes liquids A & B at a constant rate.







Other

- Cylinder speed control
- Auto adjustment of ionizer air flow rate in accordance with workpiece type and size.

Before selecting and using the products, please read all the safety precautions carefully to ensure proper product use. The safety precautions described below are to help you use the product safely and correctly, and to prevent injury or damage to you, other people, and assets.

Always adhere to the following safety regulations: ISO4414 (Pneumatic fluid power - General rules and safety requirements for systems and their components) and JIS B 8370 (Pneumatic system regulations).

The directions are ranked according to degree of potential danger or damage: DANGER, WARNING, CAUTION, and ATTENTION

 DANGER	Indicates situations that can be clearly predicted as dangerous. Death or serious injury may result if the situation is not avoided. It could also result in damage or destruction of assets.
 WARNING	Indicates situations that, while not immediately dangerous, could become dangerous. Death or serious injury may result if the situation is not avoided. It could also result in damage or destruction of assets.
 CAUTION	Indicates situations that, while not immediately dangerous, could become dangerous. Minor or semi-serious injury may result if the situation is not avoided. It could also result in damage or destruction of assets.
 ATTENTION	While there is no chance of injury, these points should be observed for appropriate use of the product.

■ This product was designed and manufactured for use in general industrial machinery.

- When selecting and handling equipment, the system designer or another person with sufficient knowledge and experience should always read the safety precautions, catalog, instruction manual and other literature before commencing operation. Improper handling is dangerous.
- After reading the instruction manual, catalog, and other documentation, always store them in a location that allows easy availability for reference to users of this product.
- Whenever transferring or lending the product to another person, always attach the catalog, instruction manual, and other information, to the product where they are easily visible in order to ensure that the new user can use the product safely and properly.
- The danger, warning, and caution items listed under these safety precautions do not cover all possible contingencies. Read the catalog and instruction manual carefully, and always keep safety first.

 **DANGER**

- Do not use the product for the purposes listed below:
 1. Medical equipment related to maintenance or management of human lives or bodies
 2. Machines or equipment designed for the purpose of moving or transporting people
 3. Critical safety components in mechanical devices
 4. Food and drink dispensers, and more
 This product has not been planned or designed for purposes that require high levels of safety. Using the product in any of the ways described above creates the risk of loss of human life.
- Do not use the product in locations with or near dangerous substances such as flammable or ignitable substances. This product is not explosion-proof. Doing so creates the risk of ignition and fire.
- While the product is in operation, avoid touching it with your hands or otherwise approaching too close. Also, do not attempt to make any adjustments to internal or attached mechanisms, or to perform any type of adjustment (detaching connectors for wires, disconnecting tubes or sealed plugs, etc.) while the product is in operation. Doing so can cause abnormal operations and other problems with the product and devices, creating the risk of personal injury.
- When mounting the product and workpiece, always make sure they are firmly supported and secured in place. Falling, dropping, or abnormal operation of the product creates the risk of personal injury.
- Users of pacemakers or other similar medical devices should maintain a distance of at least one meter from the proportional control valve. Getting too close to the product creates the risk of malfunction of a pacemaker due to the strong magnet built into the product.
- Never attempt to modify the product in any way. Abnormal operation can lead to injury.
- Never attempt inappropriate disassembly, assembly of the product relating to basic construction, or to its performance or to functions. Doing so creates the risk of injury, electric shock, fire, etc.
- Do not splash water on the product. Spraying water on the product, washing the product, or using the product under water creates the risk of malfunction, leading to injury, electric shock, fire, etc.

 **WARNING**

- Do not use the product in excess of its specification range. Doing so creates the risk of product breakdown, erratic operation, or damage.
- The media that can be used is air, neutral gas, water, and gases and fluids that do not affect component parts. Media other than those above creates the risk of sudden loss of performance or shortened service life. Contact Koganei before using other media. Use of corrosive media, in particular, creates the risk of personal injury, electric shock, fire, and other problems due to proportional control valve stress corrosion cracking, etc.
- Before supplying media or electricity to the device and before starting operation, always conduct a safety check of the area where the machine is operating. Unintentional supply of media or electricity creates the risk of electric shock or injury due to contact with moving parts.
- Before performing any kind of wiring work, be sure to turn off the power. Failure to do so creates the risk of electric shock.
- Correctly apply the rated voltage to the solenoid. Applying the wrong voltage will make it impossible to obtain the rated function, and creates the risk of damage to and burnout of the product.
- Do not touch terminals or switches while the power is turned on. Doing so creates the risk of electric shock and abnormal operation.
- Do not allow lead wires and other cords to become damaged. Allowing a cord to become damaged, bent excessively, pulled, rolled up, placed under heavy objects, or squeezed between two objects creates the risk of current leaks or defective continuity that can lead to fire, electric shock, or abnormal operation.
- Do not connect or disconnect connectors while the power is turned on. Also, never apply unnecessary force to connectors. Doing so creates the risk of personal injury, device damage, and electric shock due to abnormal machine operation.
- Always check the catalog and other reference materials for correct product wiring and piping. Improper wiring or piping creates the risk of damage to and abnormal operation of the actuator.
- When the product has been idle for over 48 hours or has been in storage, it is possible that the contacting parts may have become stuck leading to operating delays or sudden movements. Before these initial operations, always run a test to check that operating performance is normal.
- When the device has not been used for long periods (over 30 days), it is possible that the contacting parts may have become stuck leading to slow operation or sudden movements. Check for proper operation a minimum of once every 30 days.

- Do not use proportional control valves or the wiring that controls them in locations subject to surges or near strong magnetic fields or power lines through which large electric currents flow. It could result in unintended operation.
- When a proportional control valve is turned off, it may generate a surge voltage or an electromagnetic wave that affects the operation of surrounding equipment. Use surge-protected solenoids and use countermeasures for electromagnetic waves and surges to electric circuits.
- Do not use the product near the ocean, in direct sunlight, near mercury vapor lamps, or near equipment that generates ozone. Deterioration of rubber parts caused by ozone may reduce performance and functions or stop functions.
- Do not allow the product to be thrown into fire. Doing so creates the risk of the product exploding or the release of toxic gases.
- Do not sit on the product, place your foot on it, or place other objects on it.
Doing so creates the risk of injury due to tripping or the product tipping over or falling, resulting in product damage and abnormal, erratic, or runaway operation.
- Leave all maintenance, inspection, repair, piping (attachment, detachment, replacement) or similar work up to personnel who have sufficient knowledge and experience in the applicable products, media, media control systems, etc. When performing work, be sure to totally turn off media supply and also note the points below.
 1. In the case of gas, make sure to confirm that pressure inside the product and piping connected to the product is zero. In particular, be aware that residual air will still be in the air compressor or air storage tank. The actuator may move abruptly if residual air pressure remains inside the piping, causing injury.
 2. In the case of liquid, remove all liquid from inside the product and piping. Corrosive media, in particular, creates the risk of chemical burns and contamination of the surrounding area.
 3. In the case of high-temperature media, observe the precautions above and also make sure that the valve has cooled sufficiently. Unintentional contact creates the risk of burn injuries.
- When using an antifrost heater or heat insulation material to keep the product warm, use it on the main part of the product and not on the solenoid. Coil burnout creates the risk of electric shock, fire, and abnormal operation.
- Use of this product under the conditions described below comes under the jurisdiction of Japan's High Pressure Gas Safety Act. Note that violations by individuals or corporations are punishable by law.
Use of compressed gas with a gauge pressure of 1 MPa [145 psi] or greater under normal temperature or use of gas with a pressure of 1 MPa [145 psi] under conditions converted to a temperature of 35 °C [95 °F] (acetylene gas and liquefied gas are subjected to even stricter standards).
For details, refer to the High Pressure Gas Safety Act.
- When installing a proportional control valve in the control panel or when the energizing time is long, use countermeasures for heat dissipation so that the ambient temperature of the proportional control valve is always within the specified temperature range. In particular, note that continual charging of a proportional control valve that is fully open can cause an increase in resistance due to a rise in solenoid temperature, and loss of function of the temperature compensation circuit, which stabilizes the flow rate.
- Long-term continuous charging can make the coil hot. Unintentional contact creates the risk of burn injuries.
- After completing wiring work, check to make sure that all connections are correct before turning on the power.
- Design devices so fluid control equipment is not operated by an emergency stop, power outage, or other system abnormality, and so there is no chance of damage or personal injury even upon return to the non-energized state.

CAUTION

- Do not use the product in locations subject to direct sunlight (ultraviolet radiation); in locations subjected to high temperature or humidity; in locations where dust, salt, or iron particles are present; or in locations with media and/or an ambient atmosphere that includes organic solvents, phosphate ester type hydraulic oil, sulfur dioxide gas, chlorine gas, acids, etc. It could lead to early shutdown of some functions, a sudden degradation of performance, and a reduced operating life. For information about materials, see Major Parts and Materials.
- When mounting the product, leave room for adequate working space around it. Failure to do so will make it more difficult to conduct daily inspections or maintenance, which could eventually lead to system shutdown or damage to the product.
- When transporting or mounting a heavy product, firmly support the product using a lift or support, or use multiple people to ensure personal safety.
- Do not bring any magnetic media or memory within one meter of energized proportional control valves. Doing so creates the risk of damage to data on the magnetic media due to magnetism.
- Do not use a proportional control valve in locations subject to large electric currents or strong magnetic fields. It could result in erratic operation.
- Oil from the compressor (with the exception of oil-free compressors) may dramatically decrease the product's capabilities or cause the functions to stop. Be sure to remove oil from the air by installing a mist filter preceding the pneumatic equipment.
- When the media is liquid, provide a relief valve on the circuit to prevent a liquid seal around the circuit. Failure to do so can result in the valve not being able to open.

ATTENTION

- Whenever considering use of this product in situations or environments not specifically noted in the catalog or in manuals, or in applications where safety is an important requirement such as in aircraft facilities, combustion equipment, leisure equipment, safety equipment, and other places where human life or assets may be greatly affected, take adequate safety precautions such as allowing plenty of margin for ratings and performance, or fail-safe measures. Contact the sales department at Koganei regarding use in such applications.
- Always check the catalog and other reference materials for product wiring and piping.
- When handling the product, wear protective gloves, safety glasses, protective mask, safety shoes, and other protective clothing whenever necessary.
- When the product can no longer be used or is no longer necessary, dispose of it appropriately as industrial waste.
- A proportional control valve can exhibit degraded performance and function over its operating life. Always conduct daily inspections and confirm that all requisite system functions are satisfied to prevent accidents from happening.
- Proportional control valves are not completely leak-free. Designs should take into considering the capacity and retention time required for pressure retention within the pressure vessel, etc.
- For inquiries about the product, consult your nearest Koganei sales office or the Koganei Overseas Department. The addresses and telephone numbers are shown on the back cover of this catalog.

Other

- Always observe the following items.
 1. When using this product in a medium control system, use only genuine Koganei parts or compatible parts (recommended parts).
Use only authentic Koganei parts or compatible parts (recommended parts) to do maintenance or repairs.
Always observe the prescribed methods and procedures.
 2. Never inappropriately disassemble or modify the product in relation to its basic construction, performance, or functions.

Koganei cannot be held responsible for any problems that occur as a result of these safety precautions not being properly observed.



General precautions

Mounting and piping

1. Mounting and piping should be performed by personnel who have sufficient knowledge and experience, using the proper tools.
2. Though there are no restrictions on the mounting direction, the product should be mounted where it will not be directly subjected to strong impact and/or vibration. Mounting with the solenoid facing upwards is recommended in order to avoid accumulation of contaminants, etc.
3. Before installing piping, thoroughly flush the inside of the pipes (with compressed air) or blow with an air blower. Make sure that machining chips, sealing tape, rust and other debris does not get into the pipes.
4. Provide filters or strainers near proportional control valves to remove dirt from the media. Dirt accumulation inside a proportional control valve can cause malfunction and damage. Normally use a filter or strainer that is 80 to 120 mesh.
5. Watch out for filter or strainer clogging.
Clean a strainer whenever its pressure drop reaches 0.1 MPa [15 psi].
6. Check the media flow direction.
7. Seal with sealing tape.
When winding sealing tape leave 1.5 or 2 threads of the threaded part visible as shown in the figure below.

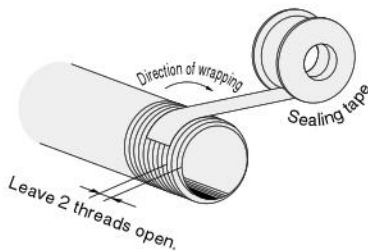

When screwing in a pipe or fitting, take care to keep metal chips and seal material from getting into the proportional control valve.

8. When tightening a pipe, fix the metal part of the valve body in place. Do not apply excessive force to the solenoid's molded resin. Doing so can damage the solenoid.
9. When performing piping work, do not apply outside force to the proportional control valve body. Applying external force can damage the proportional control valve.
10. When screwing pipes or fittings into the proportional control valve, use the appropriate tightening torque shown below.

Connecting thread	Tightening torque N·m [in·lbf]
RC1/4	11.77 to 13.73 [104.176 to 121.524]
RC3/8	21.57 to 23.54 [190.916 to 208.353]
RC1/2	27.46 to 29.42 [243.048 to 260.396]

11. Do not loosen and tighten that screws that have adhesive on them that are on top of the proportional control valve. Doing so make proper proportional control valve operation impossible.
12. When installing a proportional control valve in the control panel, or when the energizing time is long, provide ventilation and take other measures to ensure heat dissipation.

13. When using the **KFPV300** series (ϕ 6 [0.236], ϕ 8 [0.315] orifice) with high pressure (0.4 MPa [58 psi] or greater) on the primary side and the secondary side open to atmosphere, do not use with nothing attached (no load) on the secondary side. Some load (pipe resistance) is required on the secondary side.

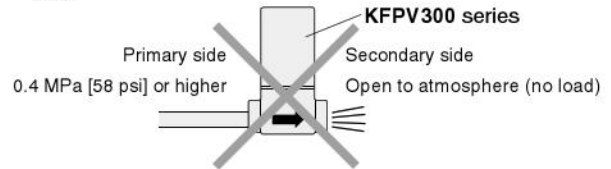

When using the product in an open atmosphere, do so as shown in the figures below (Example 1, Example 2). However, the pipe lengths shown in the figures below are not required if the end of the primary side pipe is a throttled structure (load applying structure). For details, contact Koganei.

Example 1: Proportional control valve on secondary side, and same diameter straight piping (reference)

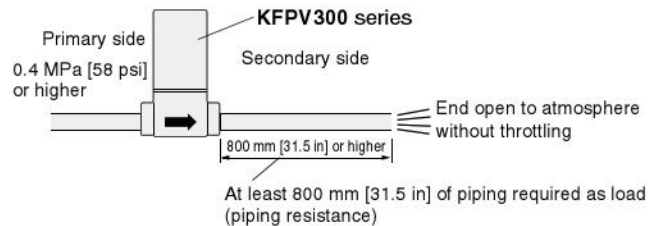

Example 2: Proportional control valve on secondary side, and same diameter elbow other bent piping (reference)

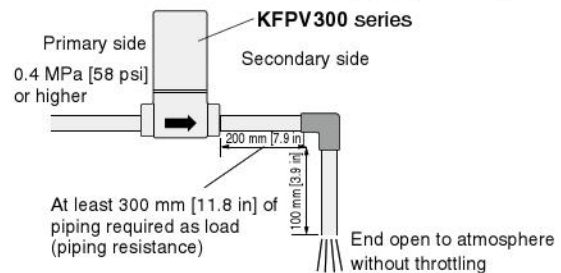

Atmosphere

Use in the locations and environments below will cause the proportional control valve to malfunction, and should be avoided. When such use is unavoidable, be sure to provide a cover and take other protective measures.

- Locations where a proportional control valve is directly exposed to water droplets, oil droplets, etc.
- Locations where condensation can form on the proportional control valve.
- Locations where a proportional control valve is directly exposed to machining chips, dust, etc.

Storage

After running water through a valve, remove all water remaining inside it before long term storage. Leaving water inside a valve can cause rust, faulty operation, seal material deterioration, and other problems.

Solenoid

1. The direction of the solenoid can be changed.

• KFPV050 series

The solenoid can be moved to any position desired. Tighten the solenoid lock nut to the torque shown below.



Model	Tightening torque N·m [in·lbf]
KFPV050	2.8 [24.783]

• KFPV300 series

The direction of the solenoid can be changed in 90° increments. Loosen the hex socket head screws ① to ④ and lift up the solenoid. There is no need to pull it out completely. After changing the orientation, temporarily tighten the screws in the following diagonal crossing pattern: ① → ③ → ② → ④. Next, tighten the screws securely. Tighten the solenoid hex socket head screws to the torque shown below.

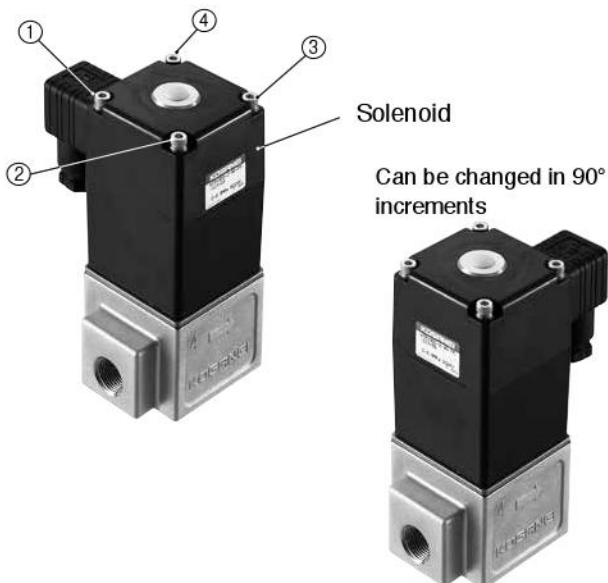

Model	Tightening torque N·m [in·lbf]
KFPV300	0.8 [7.081]

2. Though there are no restrictions on the mounting direction, mounting with the solenoid facing upwards is recommended in order to avoid accumulation of contaminants.

Procedure for connecting cables

1. Electrical connection: When using a DIN connector (KFPZ-39), insert a gasket and connect with the solenoid flat terminal. Keep the cable length within 50 m [164.042 ft].

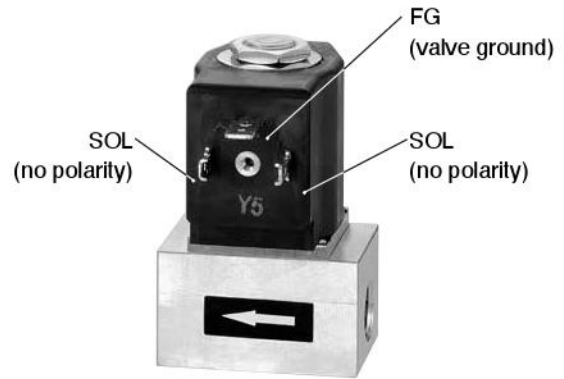

- Avoid wiring in parallel to or in the same conduit with high-voltage lines and power lines. Keep wiring as far away as possible from motors. It could result in erratic operation. If installation near an inductive load or near power lines is unavoidable, be sure to provide load surge countermeasures and isolate wiring using a magnetic shield. Environments where there is a large amount of noise from outside sources in particular create the risk of erratic operations.

2. The tightening torque of the DIN connector mounting screw is 0.3 N·m [2.655 in·lbf].

Precautions during use

1. When using media other than that recommended for a valve, it is up to you to consider compatibility between the media and the valve body material, seal material, etc.
 - Rising temperature, increased media density, and use of ultra-pure media creates the risk of accelerated corrosion.
 - Before use, be sure to perform a sample test to determine whether use of a medium is appropriate under actual use conditions.
2. The flow rate and control characteristics depend on usage conditions and setting conditions. When using a valve, test it under your actual control system conditions, and adequately determine response, stability, effectiveness, etc. Note that long-term use at low pressure and a low flow rate at a fixed opening can cause the sliding part to become stuck, resulting in defective operation.

Proportional Control Valves KFPV050 Series

Rc1/4 Direct Acting 2-port Valve,
Plunger type

Use the proportional control valve in combination
with the KFPC1 controller.

For details about controllers, refer to page 13.



Symbol

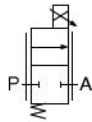

Normally closed (NC)

Basic Models and Functions

Item	Model	KFPV050
Number of positions		2 positions
Number of ports		2 ports
Circuit configuration		Normally closed (NC)

Common Specifications

Item	Basic type	KFPV050
Media ^{Note 1}		Air, neutral gas, water (other gases and liquids that do not affect component parts)
Seal material		FKM
Material for the body		Brass or stainless steel
Temperature range for media used	°C [°F]	-10 ~ 90 [-14 ~ 194] (non-freezing)
Operation system		Direct drive type
Ambient temperature range (ambient atmosphere)	°C [°F]	0 ~ 55 [32 ~ 131]
Media viscosity	m ² /s	Less than 21×10 ⁻⁶
Mounting direction ^{Note 2}		Any
Protection level		IP65 compliant

Note 1: For information about component part materials, refer to "Internal configuration and major materials" on page 9.

2: Mounting with the solenoid facing upwards is recommended in order to avoid accumulation of contaminants, etc.

Detailed Specifications

• Seal Material: FKM

Item	Port size	Orifice diameter ^{Note 1} mm [in]	Flow rate		Operating pressure differential range ^{Note 2} MPa [psij]	Maximum operating pressure MPa [psij]	Rated voltage ^{Note 3}	Power consumption W	Coil current MAX: mA	Mass g [oz]
			Cv	Effective area mm ²						
KFPV050-2-20	Rc1/4	2.0 [0.079]	0.13	2.3	0 ~ 0.7 [0 ~ 102]	3.5 [508]	24 VDC	8	300	550 [19.4]
KFPV050-2-30	Rc1/4	3.0 [0.118]	0.22	4.0	0 ~ 0.35 [0 ~ 51]					
KFPV050-2-40	Rc1/4	4.0 [0.157]	0.31	5.7	0 ~ 0.2 [0 ~ 29]					

Note 1: For information about orifice diameter selection, refer to the flow rate conversion tables on pages 15 and 16.

2: The working pressure upper limit is the highest pressure that can be applied to the inlet side of the proportional control valve. Above this pressure, valve leaking may occur, even if it is within the working pressure differential range.

3: Allowable voltage fluctuation range: rated voltage ±10%

Inner Construction and Major Parts

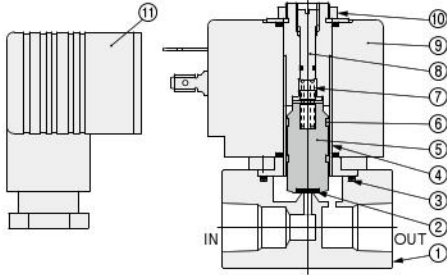

No.	Parts	Materials
①	Valve body	Brass or SUS304
②	Plunger seal	FKM
③	O-ring	FKM
④	Guide tube	SUS304
⑤	Plunger	Electromagnetic stainless steel
⑥	Wear ring	PTFE
⑦	Spring	SUS304
⑧	Stopper	SUS304
⑨	Solenoid	Polyester
⑩	Lock nut	Free-cutting steel (nickel plated)
⑪	DIN connector	Resin

Characteristics

Characteristics when used in combination with controller **KFPC1**.

Hysteresis	%F.S.	Less than 5
Repeatability	%F.S.	Less than 2
Response accuracy	%F.S.	Less than 2
Rangeability		10: 1

Note: Measurements are taken under Koganei measurement conditions.

Note 1: The characteristic curve to the right shows actual flow rate values with maximum flow rate of 100% measured under Koganei test conditions, relative to the control signal input % (current, voltage).

2: Actual flow rate characteristics depend on usage conditions and settings conditions, so check them under actual use conditions.

• Characteristic Curve

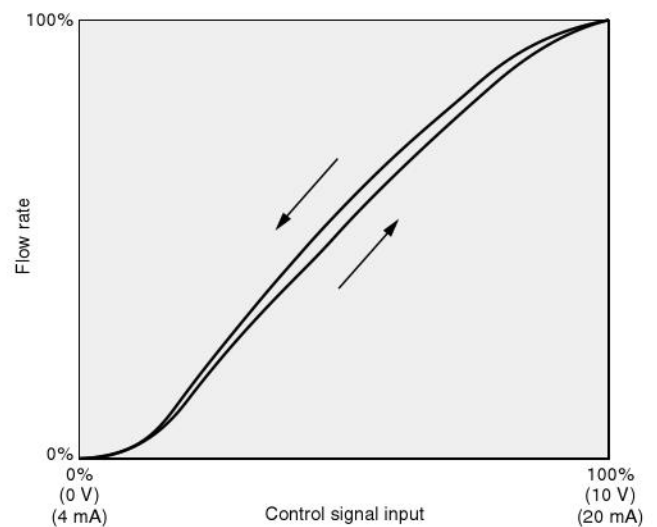

Proportional Control Valve Order Codes

Model	Circuit configuration	Orifice diameter	Seal material	Valve body material	Port size	Wiring specifications	Voltage
KFPV050	-2: 2 ports	-20: ϕ 2.0 mm [0.079 in]	-FM: FKM	-BR: Brass	-02: Rc1/4	-39: DIN With connector	24 VDC
		-30: ϕ 3.0 mm [0.118 in]		-S4: SUS304		-39N: DIN No connector	
		-40: ϕ 4.0 mm [0.157 in]					

• Controllers are sold and must be ordered separately.

• Proportional control valve controller

KFPC1-F07-DN 24 VDC

For details, see page 16.



• Order codes for DIN connectors only

DIN connector standard type

(□ 27 mm [1.063 in] port)

KFPZ-39



Proportional control valve KFPV050

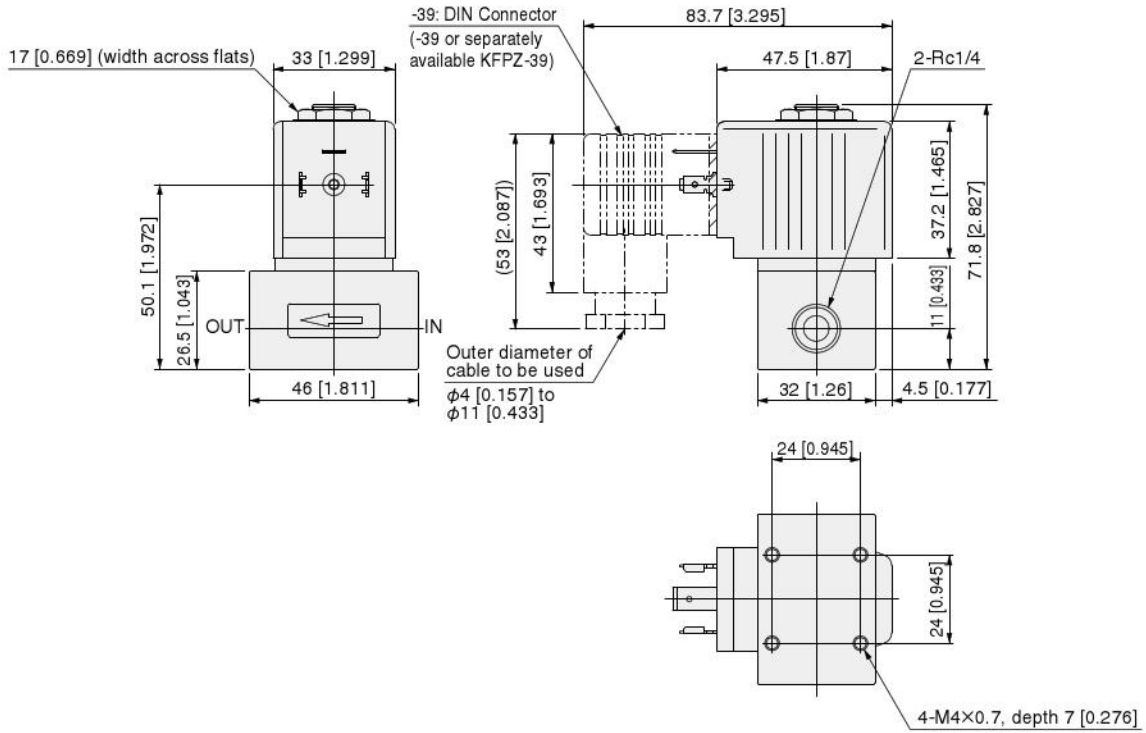

Proportional Control Valves KFPV300 Series

Rc3/8, Rc1/2 Direct Acting 2-port Valve,
Plunger type



Use in the proportional control valve in combination
with controller KFPC1.

For details about controllers, refer to page 13.

Symbol

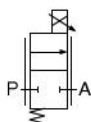

Normally closed (NC)

Basic Models and Functions

Item	Model	KFPV300
Number of positions		2 positions
Number of ports		2 ports
Circuit configuration		Normally closed (NC)

Common Specifications

Item	Basic type	KFPV300
Media ^{Note 1}		Air, neutral gas, water (other gases and liquids that do not affect component parts)
Seal material		FKM, EPDM
Material for the body		Stainless steel
Temperature range for media used	°C [°F]	-10 ~ 90 [-14 ~ 194] (non-freezing)
Operation system		Direct drive type
Ambient temperature range (ambient atmosphere)	°C [°F]	0 ~ 55 [32 ~ 131]
Media viscosity	m ² /s	Less than 21×10 ⁻⁶
Mounting direction ^{Note 2}		Any
Protection level		IP65 compliant

Note 1: For information about component part materials, refer to "Internal configuration and major materials" on page 11.

2: Mounting with the solenoid facing upwards is recommended in order to avoid accumulation of contaminants, etc.

Detailed Specifications

• Seal Material: FKM, EPDM

Item	Port size	Orifice diameter ^{Note 1} mm [in]	Flow rate		Operating pressure differential range ^{Note 2} MPa [psi]	Maximum operating pressure MPa [psi]	Rated voltage ^{Note 3}	Power consumption W	Coil current MAX: mA	Mass g [oz]
			Cv	Effective area mm ²						
KFPV300-2-40	Rc3/8	4.0 [0.157]	0.52	9.5	0 ~ 0.8 [0 ~ 116]	3.5 [508]	24 VDC	21	880	2200 [78]
KFPV300-2-60	Rc3/8	6.0 [0.236]	1.05	19.3	0 ~ 0.6 [0 ~ 87]					
KFPV300-2-80	Rc1/2	8.0 [0.315]	1.60	29.5	0 ~ 0.4 [0 ~ 58]					
KFPV300-2-100	Rc1/2	10.0 [0.394]	2.10	38.7	0 ~ 0.2 [0 ~ 29]					
KFPV300-2-120	Rc1/2	12.0 [0.472]	2.70	49.8	0 ~ 0.1 [0 ~ 15]					

Note 1: For information about orifice diameter selection, refer to the flow rate conversion tables on pages 15 and 16.

2: The working pressure upper limit is the highest pressure that can be applied to the inlet side of the proportional control valve. Above this pressure, valve leaking may occur, even if it is within the working pressure differential range.

3: Allowable voltage fluctuation range: rated voltage ±10%

Inner Construction and Major Parts

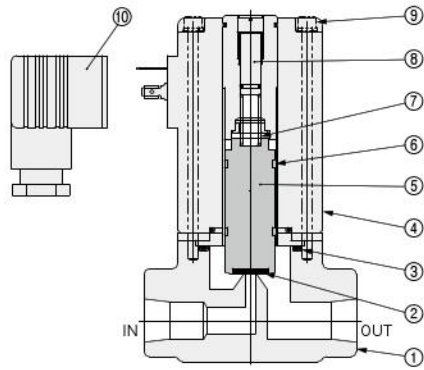

No.	Parts	Materials
①	Valve body	SCS13
②	Plunger seal	FKM, EPDM
③	O-ring	FKM, EPDM
④	Solenoid	Polyester
⑤	Plunger	Electromagnetic stainless steel
⑥	Wear ring	PTFE
⑦	Spring	SUS304
⑧	Stopper	Electromagnetic stainless steel
⑨	Hexagon socket head screw	SUS304
⑩	DIN connector	Resin

Characteristics

Characteristics when used in combination with controller **KFPC1**.

Hysteresis	%F.S.	Less than 5
Repeatability	%F.S.	Less than 1
Response accuracy	%F.S.	Less than 2
Rangeability		50: 1

Remark: Measurements are taken under Koganei measurement conditions.

Note 1: The characteristic curve to the right shows actual flow rate values with maximum flow rate of 100% measured under Koganei test conditions, relative to the control signal input % (current, voltage).

2: Actual flow rate characteristics depend on usage conditions and settings conditions, so check them under actual use conditions.

• Characteristic Curve

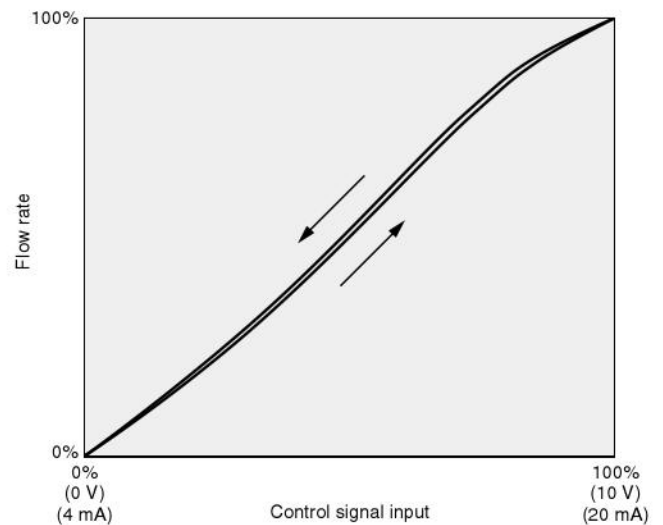

Proportional Control Valve Order Codes

Model

■ Circuit configuration	■ Orifice diameter	■ Seal material	■ Valve body material	■ Port size	■ Wiring specifications	■ Voltage
-2: 2 ports	-40: ϕ 4.0 mm [0.157 in] -60: ϕ 6.0 mm [0.236 in] -80: ϕ 8.0 mm [0.315 in] -100: ϕ 10.0 mm [0.394 in] -120: ϕ 12.0 mm [0.472 in]	-FM: FKM -AA: EPDM	-S13: SCS13 (SUS304 equivalent)	• Orifice diameters: ϕ 4.0 mm [0.157 in], ϕ 6.0 mm [0.236 in] -03: Rc3/8 • Orifice diameters: ϕ 8.0 mm [0.315 in], ϕ 10.0 mm [0.394 in], ϕ 12.0 mm [0.472 in] -04: Rc1/2	-39: DIN With connector -39N: DIN No connector	24 VDC

KFPV300	-2	-40	-FM -AA	-S13	-03	-39 -39N	24 VDC
		-60			-04		
		-80					
		-100					
		-120					

• Controllers are sold and must be ordered separately.

• Proportional control valve controller

KFPC1-F07-DN 24 VDC

For details, see page 18.



• Order codes for DIN connectors only

DIN connector standard type
(□ 27 mm [1.063 in] port)
KFPZ-39



Proportional control valve
KFPV300

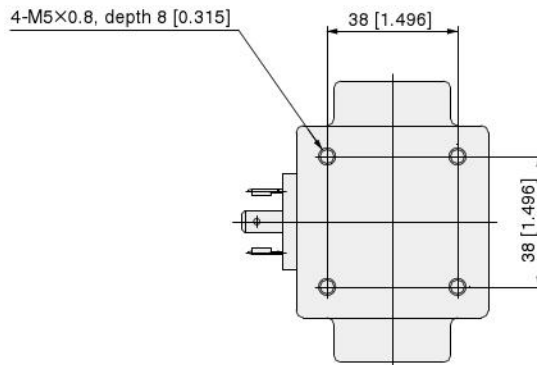
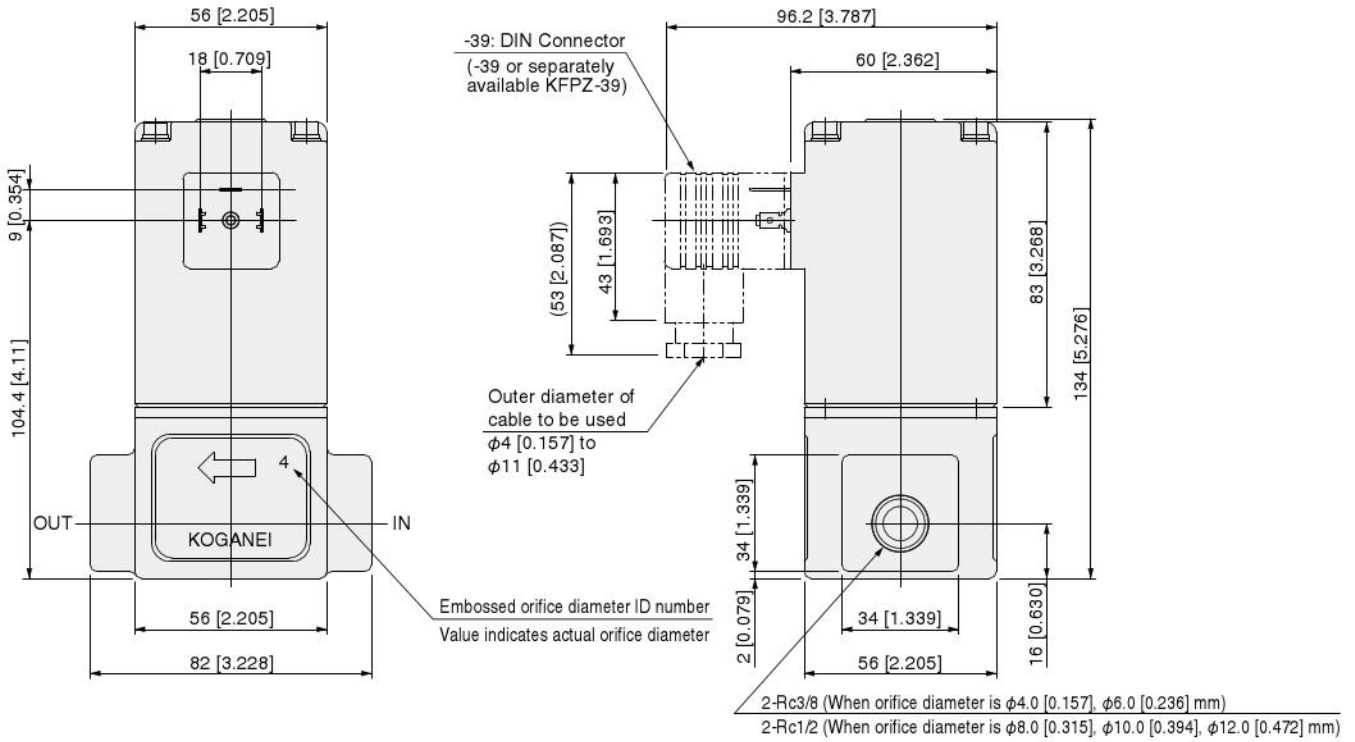

Controller for Proportional Control Valves KFPC1

For Proportional Control Valves KFPV050 and KFPV300 Series

Specifications

Item	Model	KFPC1-F07-DN 24 VDC	
Mounting methods		DIN rail mounting	
Signal input		4 ~ 20 mA	0 ~ 10 V
Input impedance	Ω	220	1.2M
Power supply voltage		24 VDC ±10%	
Valve control signal		PWM (pulse width modulation)	
Ambient temperature range (ambient atmosphere)	°C [°F]	0 ~ 50 [32 ~ 122] (non-condensation)	
Maximum allowable load current	A	1.1	
Power consumption (control circuit)	W	0.55	
Monitor signal		Directly proportional to solenoid current 1 mV = 1 mA	
RAMP response time	s	0 ~ 10	



Major Parts and Functions

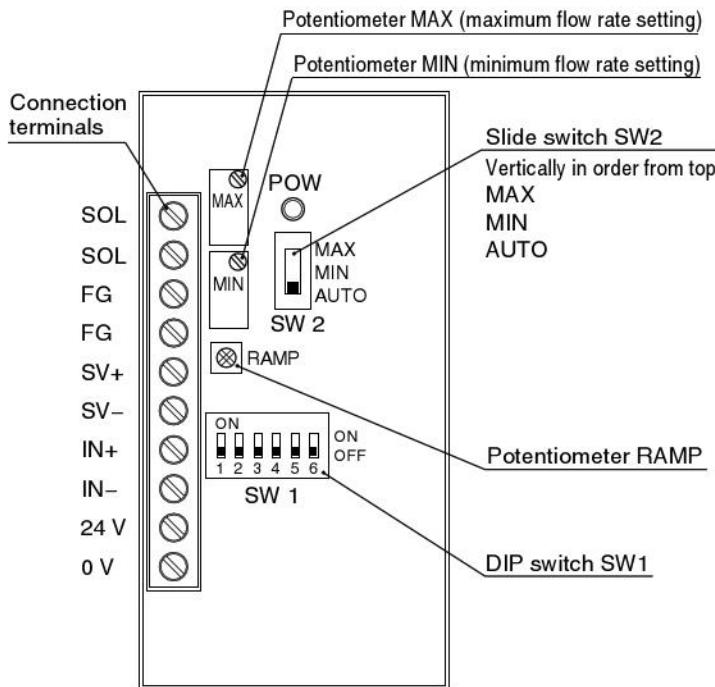

Connection terminals

- SOL Valve actuation output (No polarity)
- SOL Valve actuation output (No polarity)
- FG Valve ground
- FG Power supply frame ground
- SV+ Monitor output (+)
- SV- Monitor output (-)
- IN+ Standard signal input (+)
- IN- Standard signal input (-)
- 24 V Power supply input (+)
- 0 V Power supply input (-)

Potentiometers

- MAX For setting current value I_2 when valve is fully open
- MIN For setting current value I_1 when valve starts to open
- RAMP For ramp response time setting (0 to 10 seconds)

LED indicator

- POW Lights up when current is flowing to the solenoid.

DIP switches

- SW 1
 - 1 to 3 (SIGNAL) Selects standard signal input (4 to 20mA, or 0 to 10V)
 - 4, 5 (PWM) Switches between PWM frequencies
 - 6 (ZERO) Sets the zero point off function switch

Slide switch

- SW 2
 - MAX Input signal MAX
 - MIN Input signal MIN
 - AUTO Input signal AUTO (operation mode)

Proportional control valve controller order codes

KFPC1-F07-DN 24 VDC



Important!

For proper operation of a proportional control valve, be sure to configure initial default settings before use. (Potentiometer MIN, MAX adjustment required.) For details, refer to the instruction manual.

Proportional control valve controller
KFPC1-F07-DN

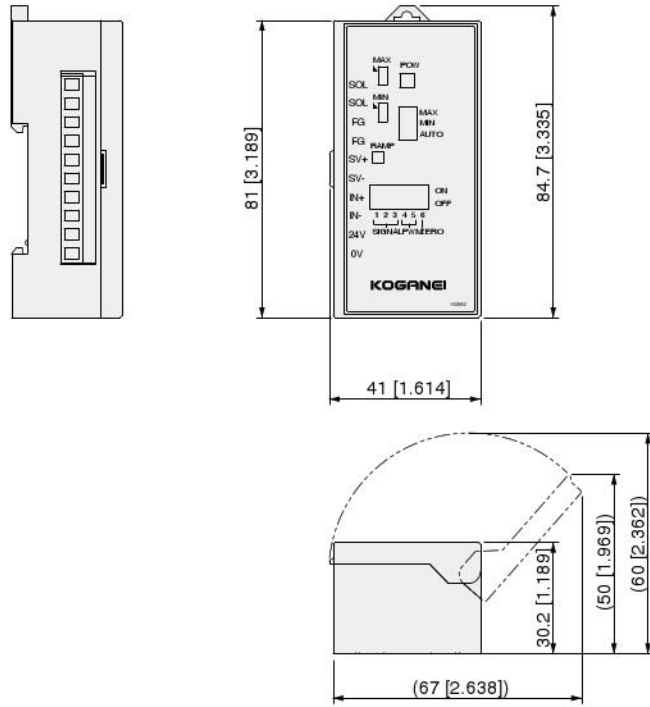

Remarks: For instructions about handling the controller, refer to the instruction manual that comes with the product.

Flow Rate Conversion Graph (water, air)

• Water Flow rate conversion graph

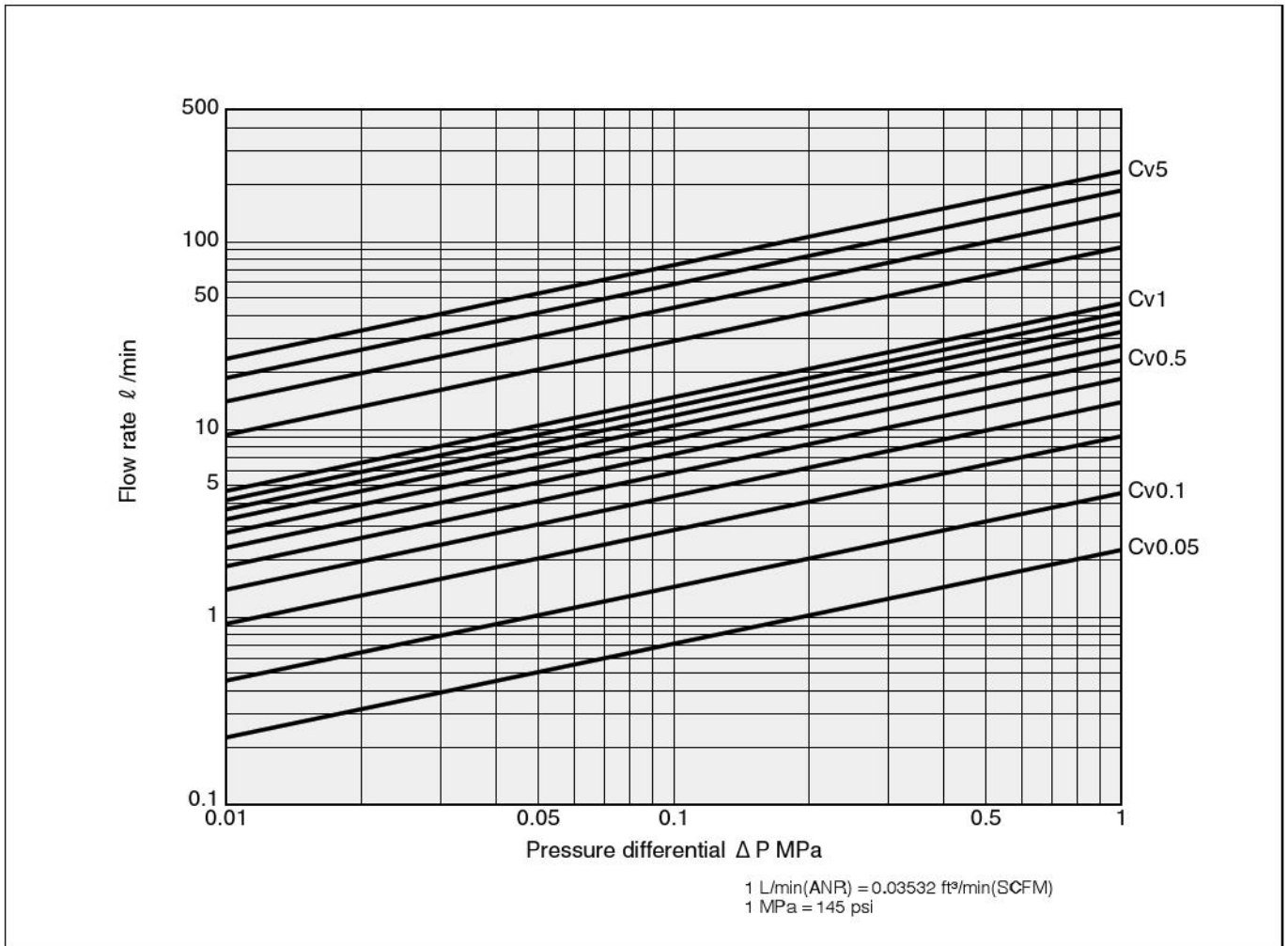

Note: Pressure differential ΔP in the graph indicates the pressure differential of primary side (upstream) gauge pressure P_1 and secondary side (downstream) gauge pressure P_2 .
 $\Delta P = P_1 - P_2$ (MPa)

Flow rate calculation formula (Formula's P_h and P_l pressure indicate absolute pressure)

$$Q = 45.62 C_v \frac{\sqrt{P_h - P_l}}{\sqrt{G}}$$

Q : Flow rate l/min
 C_v : Flow rate coefficient
 P_h : Primary side (upstream) absolute pressure MPa
 P_l : Secondary side (downstream) absolute pressure MPa
 G : Specific gravity (1 in the case of water)

Using the graph

If there is no line for the flow rate index (C_v) of the valve being used, read the flow rate in the graph for when $C_v = 1$, and then multiply it by the C_v value of the valve to be used to calculate the flow rate.

Example: Flow rate read from the graph as $C_v = 1$: $Q = 20$ l/min
 When the flow coefficient of the valve used is $C_v = 0.3$
 Calculated flow rate = $Q \times C_v = 20 \times 0.3 = 6.0$ l/min

• Air Flow rate conversion graph Cv value = 1

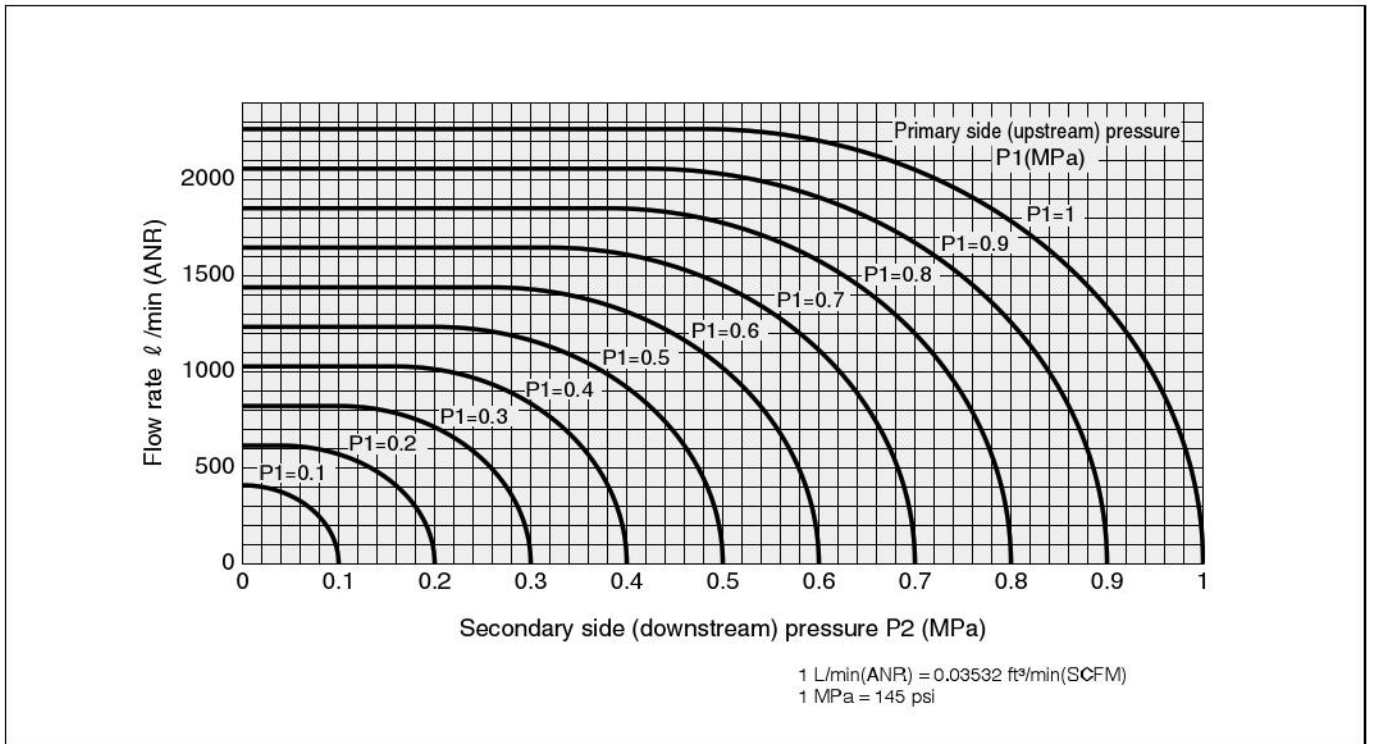

Note: Pressure P1 and P2 in the graph indicate gauge pressure (MPa).

Flow rate calculation formula (Formula's Ph and Pl pressure indicate absolute pressure)

1) When $P_l / P_h > 0.5283$

$$Q = 4119C_v \frac{\sqrt{(P_h - P_l)P_l}}{\sqrt{G}}$$

2) When $P_l / P_h \leq 0.5283$

$$Q = 2056C_v P_h \frac{1}{\sqrt{G}}$$

Q: Flow rate l /min (ANR)
 Cv: Flow rate coefficient
 Ph: Primary side (upstream) absolute pressure MPa
 Pl: Secondary side (downstream) absolute pressure MPa
 G: Specific gravity (Specific gravity with air is 1)

Using the graph

The above graph shows flow rate when the flow coefficient $C_v = 1$. When $C_v \neq 1$, multiply the flow rate read from the graph by the C_v value of the valve to be used to calculate the flow rate.

Example: Flow rate read from the graph: $Q = 500$ l /min (ANR)
 When the flow coefficient of the valve used is $C_v = 0.3$
 Calculated flow rate = $Q \times C_v = 500 \times 0.3 = 150$ l /min(ANR)

• Flow rate calculation software can be downloaded from the Koganei website. Use it for product selection.

Explanation of Terms

• Working pressure differential

Difference between input side pressure and output side pressure that can operate a proportional control valve.

• Working pressure differential range

Range between the working pressure differential upper limit (maximum working pressure differential) and lower limit (minimum working pressure differential).

• Proof pressure

Pressure that must be withstood when returning to the maximum working pressure, without causing a drop in performance. This pressure is a value subject to specification conditions.

• Power consumption

In the case of DC power, the product of the DC voltage and the DC effective current, in Watt (W) units.

• Cv value

One of the capacity coefficients. Value in US gal (U.S. gallons)/minute, expressing the flow rate of tap water of a temperature of 60°F (15.5°C) flowing through the valve when pressure differential is 1 lbf/in² (1psi).

• Orifice diameter

Diameter of a circular, cross-sectional area that is converted from the cross-sectional area of the constricted location where the valve flow path is narrowest and length is relatively shorter than the cross section dimension.

• Viscosity

Index that expresses internal friction that accompanies media flow. There is also absolute viscosity to differentiate from kinetic viscosity.

• Kinetic viscosity

Media viscosity η divided by density ρ of the media under the same conditions (temperature, pressure), which results in $\nu = \eta/\rho$. Expresses the amount of resistance when media flows when acted upon by gravity.

Normally used kinetic viscosity units are cSt (centistokes) or the SI unit m²/s (square meters per second). There is also an St (stokes) unit. For example, m²/s (square meters per second) means that for a density of 1 kg/m³, viscosity is a media kinetic viscosity of N·S/m² (Newton seconds per square meter).

The table below shows how to convert between units.

m ² /s	St	cSt
1	1×10 ⁴	1×10 ⁶
1×10 ⁻⁴	1	1×10 ²
1×10 ⁻⁶	1×10 ⁻²	1

• Hysteresis

Characteristic of a device whose output value depends upon the direction of an applied input value.

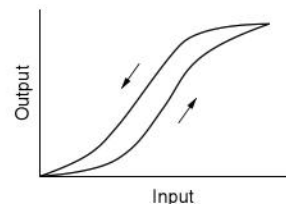

• Ramp response

Time response of transition from an invariable input state to a state that changes at a fixed speed.

• Ramp response time

For ramp response, the time it takes until the value produced, when the output primary steady state error is subtracted from the value produced by multiplying input by the static gain, falls within the specified allowable range (for example, ±5%).

• Pulse width modulation (PWM)

The frequency band is fully determined according to samples of signal F [Hz] at 1/2F [S] intervals (sampling process). There are various methods to express all the information of a sampled modulation signal (such as audio) as a pulse stream based on this process, which is called "pulse modulation." The method that modifies the sample value amplitude information in the sampled modulation code by a pulse width with a constant amplitude is called "pulse width modulation."

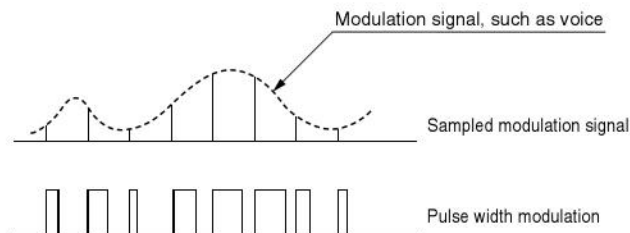

• PID control (P : Proportional action, I : Integral action, D: Derivative action)

The control device is capable three control operations: proportional control so output is proportional to input (P: Proportional action), integral control so output is an integral of input (I: Integral action), and derivative control so output is a derivative of input (D: Derivative action).

• Rangeability

Comparison of the controllable maximum and minimum flow coefficients (Cv values). When rangeability is 10:1, for example, the minimum flow coefficient Cv value is 1.0 for a maximum flow coefficient Cv value of 10.0.

• Temperature compensation

Electronic components are such that normal temperature changes or heat generated by the component changes the set current and/or voltage level. This is called "temperature drift." Temperature drift compensation is called "temperature compensation."

Limited Warranty

KOGANEI CORP. warrants its products to be free from defects in material and workmanship subject to the following provisions.

Warranty Period The warranty period is **180** days from the date of delivery.

Koganei Responsibility If a defect in material or workmanship is found during the warranty period, KOGANEI CORP. will replace any part proved defective under normal use free of charge and will provide the service necessary to replace such a part.

Limitations

- This warranty is in lieu of all other warranties, expressed or implied, and is limited to the original cost of the product and shall not include any transportation fee, the cost of installation or any liability for direct, indirect or consequential damage or delay resulting from the defects.

- KOGANEI CORP. shall in no way be liable or responsible for injuries or damage to persons or property arising out of the use or operation of the manufacturer's product.

- This warranty shall be void if the engineered safety devices are removed, made inoperative or not periodically checked for proper functioning.

- Any operation beyond the rated capacity, any improper use or application, or any improper installation of the product, or any substitution upon it with parts not furnished or approved by KOGANEI CORP., shall void this warranty.

- This warranty covers only such items supplied by KOGANEI CORP. The products of other manufacturers are covered only by such warranties made by those original manufacturers, even though such items may have been included as the components.

The specifications are subject to change without notice.

URL <http://www.koganei.co.jp>

E-mail: overseas@koganei.co.jp



KOGANEI CORPORATION

OVERSEAS DEPARTMENT

3-11-28, Midori-cho, Koganei City, Tokyo 184-8533, Japan
Tel: 81-42-383-7271 Fax: 81-42-383-7276

KOGANEI INTERNATIONAL AMERICA, INC.

39300 Civic Center Dr., Suite 280, Fremont, CA 94538, U.S.A.
Tel: 1-510-744-1626 Fax: 1-510-744-1676

SHANGHAI KOGANEI INTERNATIONAL TRADING CORPORATION

Room 2606-2607, Tongda Venture Building No.1, Lane 600, Tianshan Road,
Shanghai, 200051, China
Tel: 86-21-6145-7313 Fax: 86-21-6145-7323

TAIWAN KOGANEI TRADING CO., LTD.

Rm. 2, 13F., No88, Sec. 2, Zhongxiao E. Rd., Zhongzheng Dist., Taipei City 100,
Taiwan (ROC)
Tel: 886-2-2393-2717 Fax: 886-2-2393-2719

KOGANEI KOREA CO., LTD.

6F-601, Tower Bldg., 1005, Yeongdeop-dong, Giheung-gu, Yongin-si, Gyeonggi-do,
446-908, Korea
Tel: 82-31-246-0414 Fax: 82-31-246-0415

KOGANEI (THAILAND) CO., LTD.

3300/90, Tower B, Elephant Tower, 16th Fl., Phaholyothin Road, Chomphon,
Chatuchak, Bangkok 10900, Thailand
Tel: 66-2-937-4250 Fax: 66-2-937-4254

KOGANEI ASIA PTE. LTD.

69 Ubi Road 1, #05-18 Oxley Bizhub, Singapore 408731
Tel: 65-6293-4512 Fax: 65-6293-4513