

# Fluid Control Equipment Proportional Control Valve

## KFPV Series

**NEW**

### Small Proportional Control Valve KFPV010 Series



**Seamlessly adjust the flow rate of fluid such as gases and liquids, by changing the magnitude of current.**

- Reduce device size and weight
- Supports control at extremely low flow rates
- Supports liquid control
- Direct piping type and bottom piping type available
- ISO10993 (Biological evaluation of medical devices)-compliant models available
- CE marking-compliant

### Proportional Control Valve KFPV050 · KFPV300 Series



- Hysteresis of 5% or less is achieved (with dedicated controller)
- High accuracy, high quality, and high response
- Initial setting without external inputs
- Flexible wiring
- ISO10993 (Biological evaluation of medical devices)-compliant models available

# Fluid Control Equipment Proportional Control Valve KFPV Series

## **NEW** Small Proportional Control Valve KFPV010 Series



- Seamlessly adjust the flow rate of fluid such as gases and liquids, by changing the magnitude of current.
- Reduce device size and weight
- Supports control at extremely low flow rates
- CE marking-compliant

(w/ sub-base)



## Proportional Control Valve KFPV050 • KFPV300 Series



- Seamlessly adjust the flow rate of fluid such as gases and liquids.
- Initial setting without external inputs
- KFPV300 can control an air flow rate about six times greater than KFPV050 (comparison based on internal measurements).

**ISO10993-compliant** (for the body material SUS and rubber material FKM only)

## Proportional Control Valve KFPV Series



**The biological safety has been verified as per ISO10993\*.**

[Evaluated items]

- Cell toxicity testing
- Sensitization testing
- Irritation testing

\* ISO10993 (Biological evaluation of medical devices) is conducted as part of verification work in the risk management process as per ISO14971 (Medical devices -- Application of risk management to medical devices). This product has been verified with respect to its safety according to ISO10993.

# INDEX



Small Proportional Control Valve  
**KFPV010 Series**  
Page 8 ▶▶▶

KFPV010

Proportional Control Valve  
**KFPV050 Series**  
Page 19 ▶▶▶



KFPV050

Proportional Control Valve  
**KFPV300 Series**  
Page 22 ▶▶▶



KFPV300

Proportional Control Valve Controller  
**KFPC1 Controller**  
Page 25 ▶▶▶



KFPC1 Controller







ISO10993-compliant Proportional Control Valve  
**KFPV Series**  
Page 30 ▶▶▶

ISO10993-compliant

Before selecting and using an appropriate product, please read all the safety precautions carefully to ensure proper product use. The safety precautions described below are intended to help you use the product safely and correctly and to prevent injury to you or other people and damage to property. Always adhere to ISO4414 (Pneumatic fluid power - Recommendations for the application of equipment to transmission and control systems), JIS B 8370 (Pneumatic fluid power - General rules relating to systems), and other safety regulations.

The directions are classified according to the degree of potential danger or damage as DANGER, WARNING, CAUTION, and ATTENTION.

 DANGER	Indicates situations that can be clearly predicted as dangerous. Death or serious injury may result if the situation is not avoided. It could also result in property damage or destruction.
 WARNING	Indicates situations that, while not immediately dangerous, could become dangerous. Death or serious injury may result if the situation is not avoided. It could also result in property damage or destruction.
 CAUTION	Indicates situations that, while not immediately dangerous, could become dangerous. Minor or semi-serious injury may result if the situation is not avoided. It could also result in property damage or destruction.
 ATTENTION	While there is no chance of injury, these instructions should be observed for appropriate use of the product.

- **This product was designed and manufactured for use in general industrial machinery.**
- When selecting and handling equipment, the system designer or another person with sufficient knowledge and experience should always read the safety precautions, catalog, instruction manual and other literature before commencing operation. Improper handling is dangerous.
- After reading the instruction manual, catalog, and other documentation, always store them in a location that allows easy availability for reference to users of this product.
- Whenever transferring or lending the product to another person, always attach the catalog, instruction manual, and other information to the product where they are easily visible in order to ensure that the new user can use the product safely and properly.
- The danger, warning, and caution items listed under these safety precautions do not cover all possible contingencies. Read the catalog and instruction manual carefully, and always keep safety first.

 DANGER

- Do not use the product for the purposes listed below:
  1. Medical equipment related to maintenance or management of human life or health
  2. Machines or equipment designed for the purpose of moving or transporting people
  3. Critical safety components in mechanical devices
  4. Food and drink dispensers, and more
 This product has not been planned or designed for purposes that require high levels of safety. Using the product in any of the ways described above creates the risk of loss of human life.
- Do not use the product in locations with or near dangerous substances such as flammable or ignitable substances. This product is not explosion-proof. Doing so creates the risk of ignition and fire.
- While the product is in operation, avoid touching it with your hands or otherwise approaching too close. Also, do not attempt to make any adjustments to internal or attached mechanisms, or to perform any type of adjustment (detaching connectors for wires, disconnecting tubes or sealed plugs, etc.) while the product is in operation. Doing so can cause abnormal operations and other problems with the product and devices, creating the risk of personal injury.
- When mounting the product and workpiece, always make sure they are firmly supported and secured in place. Falling, dropping, or abnormal operation of the product creates the risk of personal injury.
- Users of pacemakers or other similar medical devices should maintain a distance of at least one meter [3.280 ft] from the proportional control valve. Getting too close to the product creates the risk of malfunction of a pacemaker due to the strong magnet built into the product.
- Never attempt to modify the product in any way. Abnormal operation can lead to injury.
- Never attempt inappropriate disassembly or assembly of the product relating to basic construction, or to its performance or to functions. Doing so creates the risk of injury, electric shock, fire, etc.
- Do not splash water on the product. Spraying water on the product, washing the product, or using the product under water creates the risk of malfunction, leading to injury, electric shock, fire, etc.

 WARNING

- Do not use the product in excess of its specification range. Doing so creates the risk of product breakdown, erratic operation, or damage. Also, significantly reduced service life results.
- The media that can be used are air, neutral gas, water, and gases and liquids that do not affect component parts. Media other than those above create the risk of sudden loss of performance or shortened service life. The use of these media is on your own responsibility. Use of corrosive media, in particular, creates the risk of personal injury, electric shock, fire, and other problems due to proportional control valve stress corrosion cracking, etc.
- Before supplying a medium or electricity to the device and before starting operation, always conduct a safety check of the area where the machine is operating. Unintentional supply of a medium or electricity creates the risk of electric shock or injury due to contact with moving parts.
- Before performing any kind of wiring work, be sure to turn off the power. Failure to do so creates the risk of electric shock.
- Correctly apply the rated voltage (for KFPV(A)010, the rated current) to the controller for KFPV050 and KFPV300, or to the solenoid for KFPV010. Applying the wrong voltage will make it impossible to obtain the rated function, and create the risk of damage to and burnout of the product.
- Do not touch terminals or switches while the power is turned on. Doing so creates the risk of electric shock and abnormal operation.
- Do not allow lead wires and other cords to become damaged. Allowing a cord to become damaged, bent excessively, pulled, rolled up, placed under heavy objects, or squeezed between two objects creates the risk of current leaks or defective continuity that can lead to fire, electric shock, or abnormal operation.
- Do not connect or disconnect connectors while the power is turned on. ● Also, never apply unnecessary force to connectors. Doing so creates the risk of personal injury, device damage, and electric shock due to abnormal machine operation.
- Always check the catalog and other reference materials for correct product wiring and piping. Improper wiring or piping creates the risk of abnormal operation of the actuator.
- When the product has been idle for over 48 hours or has been in storage, it is possible that the sliding parts may have become stuck leading to operating delays or sudden movements at initial operations. Before these initial operations, always run a test to check that operating performance is normal.
- When the device has not been used for long periods (over 30 days), it is possible that the sliding parts may have become stuck leading to slow operation or sudden movements, eventually resulting in injury. Check for proper operation a minimum of once every 30 days.

- Do not use proportional control valves or the wiring that controls them in locations subject to surges or near strong magnetic fields or power lines through which large electric currents flow. Doing so could result in unintended operation.
- When a proportional control valve is turned off, it may generate a surge voltage or an electromagnetic wave that affects the operation of surrounding equipment. Use surge protected solenoids and use countermeasures for electromagnetic waves and surges to electric circuits.
- Do not use the product near the ocean, in direct sunlight, near mercury vapor lamps, or near equipment that generates ozone. Deterioration of rubber parts caused by ozone may reduce performance and functions or stop functions.
- Do not allow the product to be thrown into fire. Doing so creates the risk of the product exploding or the release of toxic gases.
- Do not sit on the product, place your foot on it, or place other objects on it.  
Doing so creates the risk of injury due to tripping or the product tipping over or falling, resulting in product damage and abnormal, erratic, or runaway operation.
- Leave all maintenance, inspection, repair, piping (attachment, detachment, replacement) or similar work up to personnel who have sufficient knowledge and experience in the applicable products, media, medium control systems, etc. When performing work, be sure to totally turn off medium supply and also note the points below.
  1. In the case of gas, make sure to confirm that pressure inside the product and piping connected to the product is zero. In particular, be aware that residual air will still be in the air compressor or air storage tank. The actuator may move abruptly if residual air pressure remains inside the piping, causing injury.
  2. In the case of liquid, remove all liquid from inside the product and piping. Corrosive media, in particular, create the risk of chemical burns and contamination of the surrounding area.
  3. In the case of high-temperature media, observe the precautions above and also make sure that the valve has cooled sufficiently. Unintentional contact creates the risk of burn injuries.
- When using an antifrost heater or heat insulation material to keep the product warm, use it on the main part of the product and not on the solenoid. Coil burnout creates the risk of electric shock, fire, and abnormal operation.
- Use of this product under the conditions described below comes under the jurisdiction of Japan's High Pressure Gas Safety Act. Note that violations by individuals or corporations are punishable by law.  
Use of compressed gas with a gauge pressure of 1 MPa [145 psi] or greater under normal temperature or use of gas with a pressure of 1 MPa [145 psi] under conditions converted to a temperature of 35°C [95°F] (acetylene gas and liquefied gas are subjected to even stricter standards).  
For details, refer to the High Pressure Gas Safety Act.
- When installing a proportional control valve in the control panel or when the energizing time is long, use countermeasures for heat dissipation so that the ambient temperature of the proportional control valve is always within the specified temperature range. In particular, note that continual charging of a proportional control valve that is fully open can cause an increase in resistance due to a rise in solenoid temperature, and loss of function of the temperature compensation circuit, which stabilizes the current value. (When KFPC1 is used)
- Long-term continuous charging can make the coil hot. Unintentional contact creates the risk of burn injuries.
- After completing wiring work, check to make sure that all connections are correct before turning on the power.
- Design devices so fluid control equipment will stop operating in case of an emergency stop, power outage, or other system abnormality, and so there is no chance of damage or personal injury even upon return to the non-energized state.

## CAUTION

- Do not use the product in locations subject to direct sunlight (ultraviolet radiation); in locations subjected to high temperature or humidity; in locations where dust, salt, or iron particles are present; or in locations with media and/or an ambient atmosphere that includes organic solvents, phosphate ester type hydraulic oil, sulfur dioxide gas, chlorine gas, acids, etc. It could lead to early shutdown of some functions, a sudden degradation of performance, and a reduced operating life. For information about materials, refer to "Materials of Major Parts."
- When mounting the product, leave room for adequate working space around it. Failure to do so will make it more difficult to conduct daily inspections or maintenance, which could eventually lead to system shutdown or damage to the product.
- When transporting or mounting a heavy product, firmly support the product using a lift or support, or use multiple people to ensure personal safety.
- Do not bring any magnetic medium or memory within 1 m [3.280 ft] of an energized proportional control valve. Doing so creates the risk of damage to data on the magnetic medium due to magnetism.
- Do not use a proportional control valve in locations subject to large electric currents or strong magnetic fields. It could result in erratic operation.
- Oil from the compressor (with the exception of oil-free compressors) may dramatically decrease the product's capabilities or cause the functions to stop. Be sure to remove oil from the air by installing a mist filter preceding the pneumatic equipment.
- When the medium is liquid, provide a relief valve on the circuit to prevent a liquid seal around the circuit. Failure to do so can result in the valve not being able to open.

## ATTENTION

- Whenever considering use of this product in situations or environments not specifically noted in the catalog or in manuals, or in applications where safety is an important requirement such as in aircraft facilities, combustion equipment, leisure equipment, safety equipment, and other places where human life or assets may be greatly affected, take adequate safety precautions such as allowing plenty of margin for ratings and performance, or fail-safe measures. Contact Koganei regarding use in such applications.
- Always check the catalog and other reference materials for product wiring and piping.
- When handling the product, wear protective gloves, safety glasses, protective mask, safety shoes, and other protective clothing whenever necessary.
- When the product can no longer be used or is no longer necessary, dispose of it appropriately as industrial waste.
- A proportional control valve can exhibit degraded performance and functions over its operating life. Always conduct daily inspections and confirm that all requisite system functions are satisfied to prevent accidents from happening.
- Proportional control valves are not completely leak-free. Designs should take into consideration the capacity and retention time required for pressure retention within the pressure vessel, etc.
- For inquiries about the product, consult your nearest Koganei sales office or the Overseas Department. The addresses and telephone numbers are shown on the back cover of this catalog.

## Other

- Always observe the following items.
  1. When using this product in a medium control system, use only genuine Koganei parts or compatible parts (recommended parts).  
Use only genuine Koganei parts or compatible parts (recommended parts) to do maintenance or repairs.  
Always observe the prescribed methods and procedures.
  2. Never inappropriately disassemble or modify the product in relation to its basic construction, performance, or functions.

Koganei cannot be held responsible for any problems that occur as a result of these safety precautions not being properly observed.



General precautions

**Notes on use**

1. When using a medium other than that recommended for a valve, it is up to you to consider compatibility between the medium and the valve body material, seal material, etc.
  - Rising temperature, increased medium concentration, and use of an ultra-pure medium creates the risk of accelerated corrosion.
  - Before use, be sure to perform a sample test to determine whether use of a medium is appropriate under actual use conditions.
2. The flow rate and control characteristics depend on service conditions and set conditions. When using a valve, test it under your actual control system conditions, and adequately verify response, stability, effectiveness, etc.  
 Note that long-term use with a fixed opening at low pressure and a low flow rate can cause the sliding part to become stuck, resulting in malfunction.

**Mounting and piping**

1. Mounting and piping should be performed by personnel who have sufficient knowledge and experience, using the proper tools.
2. Though there are no restrictions on the mounting direction, the product should be mounted where it will not be directly subjected to strong impact and/or vibration. Mounting with the solenoid facing upwards is recommended in order to avoid accumulation of contaminants, etc.
3. Before installing piping, thoroughly flush the inside of the pipes (with compressed air) or blow with an air blower. Make sure that machining chips, sealing tape, rust and other debris does not get into the pipes.
4. Provide filters or strainers near proportional control valves to remove dirt from the media. Dirt accumulation inside a proportional control valve can cause malfunction and damage. When using a liquid, use an 80- to 120-mesh filter or strainer for KFPV050 and KFPV300 Series, and 120- to 200-mesh filter or strainer for KFPV(A)010 Series. When using air, use clean air free of deteriorated compressor oil, etc. Provide air filters (filtration rating: 40 µm or less) near the valve to remove drain and dirt. Also, drain these air filters periodically.
5. Watch out for filter or strainer clogging.  
 Clean a strainer whenever its pressure drop reaches 0.1 MPa [15 psi].
6. Check the medium flow direction.
7. When the medium is a liquid, design devices so that the circuit will not be sealed by the liquid. (Failure to do so may cause an abnormal pressure rise due to temperature change.)
8. Note that rust may occur if water remains inside the product. Depending on the quality of water, the brass body may cause dezincification corrosion.

9. Seal with sealing tape.

When winding sealing tape, leave 1.5 or 2 threads of the threaded part visible as shown in the figure below.

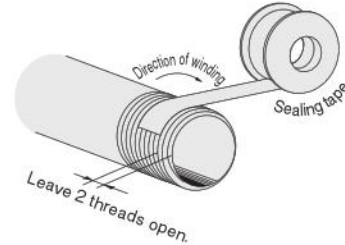

When screwing in a pipe or fitting, take care to keep metal chips and seal material from getting into the proportional control valve.

10. When tightening a pipe, fix the metal part of the valve body in place. Do not apply excessive force to the solenoid's molded resin. Doing so can damage the solenoid.
11. When performing piping work, do not apply external force to the proportional control valve body. Applying external force can damage the proportional control valve.
12. When screwing pipes or fittings into the proportional control valve, use the appropriate tightening torque shown below.

Connecting thread	Tightening torque N·m [in·lbf]
M5	1 to 1.5 [8.851 to 13.277]
Rc1/8	4.5 to 6.5 [39.830 to 57.532]
Rc1/4	7 to 9 [61.957 to 79.659]
Rc3/8	12.5 to 14.5 [110.6 to 128.3]
Rc1/2	30 to 22 [265.5 to 194.7]

13. Do not loosen or tighten screws that are on top of the proportional control valve and have adhesive on them. Doing so can make proper proportional control valve operation impossible. For KFPV010 Series, do not remove the white cap on top of the coil. Doing so can make proper proportional control valve operation impossible.
14. When installing a proportional control valve in the control panel, or when the energizing time is long, provide ventilation and take other measures to ensure heat dissipation.
15. When using the **KFPV300 Series** (φ6 [0.236], φ8 [0.315] orifice) with high pressure (0.4 MPa [58 psi] or greater) on the primary side and the secondary side open to atmosphere (no load) on the secondary side. Some load (pipe resistance) is required on the secondary side.

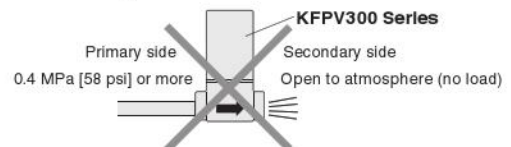

When using the product in an open atmosphere, do so as shown in the figures below (Example 1, Example 2). However, the pipe lengths shown in the figures below are not required if the end of the secondary side pipe is a throttled structure (load applying structure). For details, contact Koganei.

**Example 1: When the secondary side has the same diameter as the proportional control valve and has a straight pipe (for reference)**

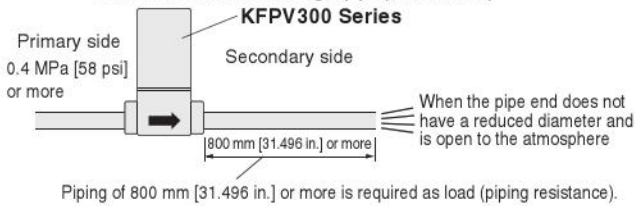

**Example 2: When the secondary side has the same diameter as the proportional control valve and has a bent pipe, such as an elbow (for reference)**

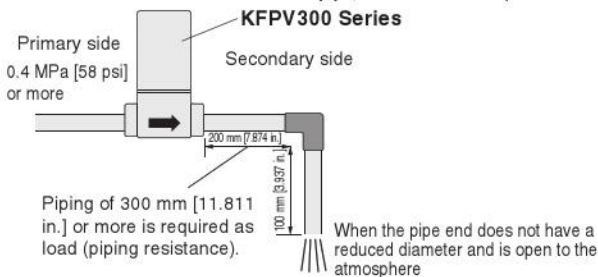

### 17. Valve tightening torque for KFPVA010

Model	Tightening torque N·m [in·lbf]
KFPVA010 (bottom piping type)	0.176 [1.558]

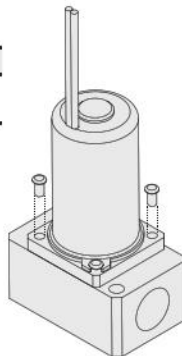

#### Solenoid

### ● KFPV010 Series

1. The direction of the solenoid cannot be changed.



2. Though there are no restrictions on the mounting direction, mounting with the solenoid facing upwards is recommended in order to avoid accumulation of contaminants.

When using the product at a pressure close to the maximum working pressure, use it with the solenoid facing upwards. The solenoid is balanced by the attracting force and spring. Do not apply excessive impact and/or vibration to the solenoid.

### ● KFPV050 Series

1. The direction of the solenoid can be changed.

The solenoid can be moved to any position desired.

Tighten the solenoid lock nut to the torque shown below.

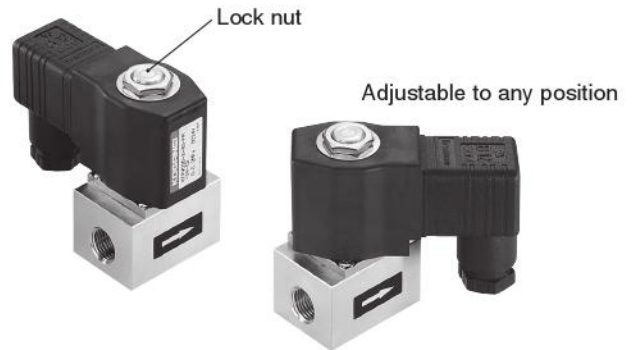

Model	Tightening torque N·m [in·lbf]
KFPV050	2.8 [24.783]

### ● KFPV300 Series

1. The direction of the solenoid can be changed in 90° increments. Loosen the hex socket head screws ① to ④ and lift up the solenoid. (There is no need to pull it out completely.) After changing the orientation, temporarily tighten the screws in the following diagonal crossing pattern: ① → ③ → ② → ④. Next, tighten the screws securely. Tighten the solenoid hex socket head screws to the torque shown below.

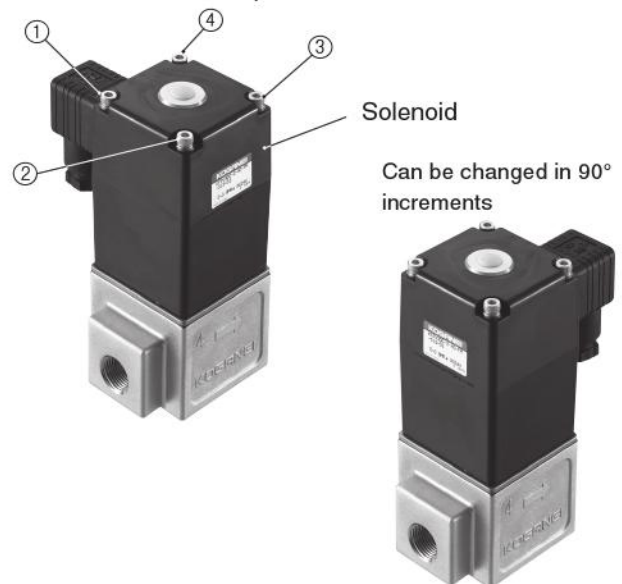

Model	Tightening torque N·m [in·lbf]
KFPV300	0.8 [7.081]

2. Though there are no restrictions on the mounting direction, mounting with the solenoid facing upwards is recommended in order to avoid accumulation of contaminants.

Procedure for connecting cables

● **KFPV010 Series**

1. The product is not polar.
2. Do not use the product with the lead wire pulled or subjected to oscillations.



● **KFPV050 and KFPV300 Series**

1. Electrical connection: When using a DIN connector (KFPZ-39), insert a gasket and connect with the solenoid flat terminal. Keep the cable length within 50 m [164.0 ft].

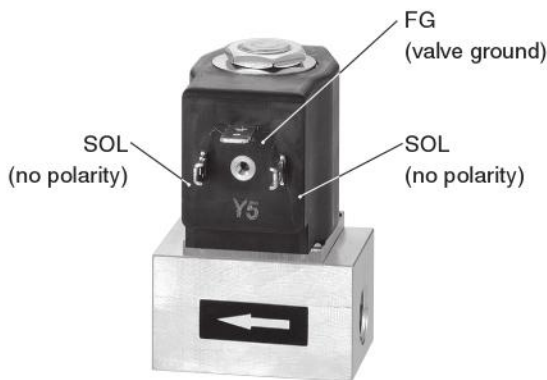

- Avoid wiring in parallel to or in the same conduit with high-voltage lines and power lines. Keep wiring as far away as possible from motors. It could result in erratic operation. If installation near an inductive load or near power lines is unavoidable, be sure to provide load surge countermeasures and isolate wiring using a magnetic shield. Environments where there is a large amount of noise from outside sources in particular create the risk of erratic operations.

2. The tightening torque of the DIN connector mounting screw is 0.3 N•m [2.655 in•lbf].

Warranty and disclaimer

1. Warranty Period

The warranty period of Koganei products is one year from the date of delivery.

\* Some products have a two-year warranty period. For details, contact the nearest Koganei sales office or Overseas Department.

2. Warranty scope and disclaimer

- (1) If a failure attributable to Koganei is found in a product purchased from Koganei or an authorized retailer/dealer during the warranty period, Koganei will repair or replace it free of charge. For some products, the service life, typically represented by the number of operations, may be specified in their warranty periods. For details, contact the nearest Koganei sales office or Overseas Department.
- (2) The warranty of each Koganei product shall apply to that product alone. Consequently, Koganei shall in no way be responsible for any incidental damage (including costs incurred for the repair and replacement of the product) attributable to any failure of the Koganei product, decrease in function, or decrease in performance.
- (3) Koganei shall in no way be responsible for any damage induced by any failure of the Koganei product, decrease in function, or decrease in performance or any damage to other devices attributable to the same.
- (4) Koganei shall in no way be responsible for any damage due to use or storage beyond the range in the product specifications mentioned in the Koganei catalog and the Instruction Manual or due to any acts not mentioned in the mounting, installation, adjustment, maintenance, and other notes.
- (5) Koganei shall in no way be responsible for any damage caused by any failure of the Koganei product due to any fire not attributable to Koganei, any natural disaster, any act by a third party, the intention or negligence of the customer, etc.



# Fluid Control Equipment Small Proportional Control Valve KFPV010 Series



**Sub-base options available!**  
(for bottom piping type only)



KFPV010

KFPV050

KFPV300

KFPC1 Controller

ISO10993-compliant

# Fluid Control Equipment Small Proportional Control Valve

## KFPV010 Series

Seamlessly adjust the flow rate of fluid such as gases and liquids, by changing the magnitude of current.

**Small Proportional Control Valve KFPV010 Series now on sale!**

- Reduce device size and weight
- Supports control at extremely low flow rates
- Orifice diameter:  
Five different types are available:  
 $\phi$  0.4 [0.016],  $\phi$  0.8 [0.031],  $\phi$  1.2 [0.047],  
 $\phi$  1.6 [0.063], and  $\phi$  2.0 [0.079].
- Hysteresis of 10% or less is achieved without a controller
- Body material: SUS, brass
- ISO10993 (Biological evaluation of medical devices)-compliant models available (for the body material SUS only)
- CE marking-compliant
- Available with liquids



Sub-base options available!  
(KFPV010 only)



Low hysteresis is achieved with a dedicated controller (KFPC1)

**When used with a controller: Hysteresis 5% or less**

\* For details on the 24VDC controller, refer to page 25. If a 12VDC model is desired, contact the sales representative or the nearest Koganei sales office.



KFPV010

KFPV050

KFPV300

KFPC1 Controller

ISO10993-compliant

## Symbol

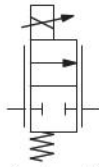

Normally closed (NC)

## Basic Models and Functions

Item	Model	KFPV(A)010
Number of positions		2 positions
Number of ports		2 ports
Circuit configuration		Normally closed (NC)

## General Specifications

Item	Basic type	KFPV(A)010
Medium <sup>Note 1</sup>		Air, neutral gas, water (other gases and liquids that do not affect component parts)
Seal material		FKM
Body material		Brass or stainless steel
Operating temperature range	°C [°F]	0 to 55 [32 to 131]
Operating method		Direct acting type
Medium viscosity	m <sup>2</sup> /s	1 × 10 <sup>-6</sup> or less
Mounting direction <sup>Note 2</sup>		Any
Protection level		IP40

Note 1: For information about component part materials, refer to "Internal Configuration and Materials of Major Parts" on page 10.

2: Mounting with the solenoid facing upwards is recommended in order to avoid accumulation of contaminants, etc.

When using the product at a pressure close to the maximum working pressure, install it with the solenoid facing upwards.

## Detailed Specifications

### ● Direct piping type

Item Model	Port size	Orifice diameter <sup>Note 1</sup> φ (mm [in.])	Flow rate			Working pressure differential range <sup>Note 2</sup> (MPa [psi])
			Cv value	C value	Effective cross-sectional area	
KFPV010-2-04	M5	0.4 [0.016]	0.006	0.02	0.1 [1.845]	0 to 0.7 [0 to 102]
KFPV010-2-08		0.8 [0.031]	0.02	0.07	0.35 [6.458]	0 to 0.4 [0 to 58]
KFPV010-2-12		1.2 [0.047]	0.035	0.13	0.65 [11.993]	0 to 0.2 [0 to 29]
KFPV010-2-16		1.6 [0.063]	0.06	0.21	1.05 [19.373]	0 to 0.1 [0 to 15]
KFPV010-2-20	Rc1/8	2 [0.079]	0.075	0.27	1.35 [24.908]	0 to 0.05 [0 to 7]

Item Model	Proof pressure (MPa [psi])	Power supply used (V)	Power consumption (W)	Resistance (Ω)	Coil current <sup>Note 3</sup> (mA)	Mass (g [oz])
KFPV010-2-04	1.05 [152]	DC12V DC24V	0 to 2.1	DC12V: 51 DC24V: 210	DC12V: 0 to 200 DC24V: 0 to 100	77 [2.72]
KFPV010-2-08						
KFPV010-2-12						
KFPV010-2-16						
KFPV010-2-20						91 [3.21]

### ● Bottom piping type

Item Model	Port size	Orifice diameter <sup>Note 1</sup> φ (mm [in.])	Flow rate			Working pressure differential range <sup>Note 2</sup> (MPa [psi])
			Cv value	C value	Effective cross-sectional area	
KFPVA010-2-04	Rc1/8 (w/ sub-base)	0.4 [0.016]	0.006	0.02	0.1 [1.845]	0 to 0.7 [0 to 102]
KFPVA010-2-08		0.8 [0.031]	0.02	0.07	0.35 [6.458]	0 to 0.4 [0 to 58]
KFPVA010-2-12		1.2 [0.047]	0.035	0.13	0.65 [11.993]	0 to 0.2 [0 to 29]
KFPVA010-2-16		1.6 [0.063]	0.06	0.21	1.05 [19.373]	0 to 0.1 [0 to 15]
KFPVA010-2-20		2 [0.079]	0.075	0.27	1.35 [24.908]	0 to 0.05 [0 to 7]

Item Model	Proof pressure (MPa [psi])	Power supply used (V)	Power consumption (W)	Resistance (Ω)	Coil current <sup>Note 3</sup> (mA)	Mass (g [oz])
KFPVA010-2-04	1.05 [152]	DC12V DC24V	0 to 2.1	DC12V: 51 DC24V: 210	DC12V: 0 to 200 DC24V: 0 to 100	53 [1.87] (w/ sub-base: 122 [4.30])
KFPVA010-2-08						
KFPVA010-2-12						
KFPVA010-2-16						
KFPVA010-2-20						

Note 1: For information about orifice diameter selection, refer to the graphs on page 13.

2: The working pressure upper limit is the highest pressure that can be applied to the inlet side of the proportional control valve. Above this pressure, valve leaking may occur, even if it is within the working pressure differential range.

3: If the product is continuously energized with the maximum current, be sure to keep the medium flowing, as the temperature rises significantly due to increased coil temperature.

# Internal Configuration and Materials of Major Parts

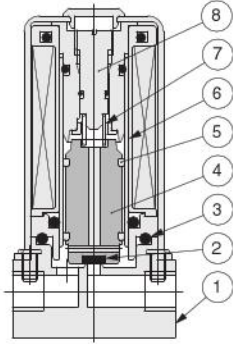

No.	Name	Material
①	Valve body	Brass or SUS304
②	Plunger seal	FKM
③	O-ring	FKM
④	Plunger	Electromagnetic stainless steel
⑤	Wear ring	PTFE
⑥	Guide tube	SUS304
⑦	Spring	SUS304
⑧	Adjustment screw	SUS304

## Small Proportional Control Valve Order Codes

(w/ sub-base)

	Circuit configuration	Orifice diameter	Seal material	Valve body material	Port size	Sub-base	Voltage
	-2: 2 ports	-04: $\phi$ 0.4 mm [0.016 in.] -08: $\phi$ 0.8 mm [0.031 in.] -12: $\phi$ 1.2 mm [0.047 in.] -16: $\phi$ 1.6 mm [0.063 in.] -20: $\phi$ 2.0 mm [0.079 in.]	-FM: FKM	-S4: SUS304 -BR: Brass*	Orifice diameter: $\phi$ 0.4 [0.016], $\phi$ 0.8 [0.031], $\phi$ 1.2 [0.047], $\phi$ 1.6 [0.063] -M5: M5  Orifice diameter: $\phi$ 2 [0.079] -01: Rc1/8	Blank: w/o sub-base -25: w/ sub-base	DC12V DC24V

Basic format

<b>KFPV010</b> (direct piping)	-2	-04	-FM	-S4 -BR*	-M5	DC12V DC24V
		-08				
		-12				
		-16				
		-20				
<b>KFPVA010</b> (bottom piping)	-2	-04	-FM	-S4 -BR*	Blank	DC12V DC24V
		-08				
		-12				
		-16				
		-20				

\* -BR indicates that biological safety evaluation has not been performed as per ISO10993.

KFPV010

KFPV050

KFPV300

KFPC1 Controller

ISO10993-compliant

# Current-Flow Curves

Item	Hysteresis (%) <sup>Note 1</sup>		Repeatability (%) <sup>Note 4</sup>	
	Average <sup>Note 2</sup>	w/ controller <sup>Note 3</sup>	Average <sup>Note 2</sup>	w/ controller <sup>Note 3</sup>
KFPV010-2-04	10	5 or less	2 or less (at the maximum working pressure differential)	
KFPV010-2-08				
KFPV010-2-12				
KFPV010-2-16				
KFPV010-2-20				

Item	Hysteresis (%) <sup>Note 1</sup>		Repeatability (%) <sup>Note 4</sup>	
	Average <sup>Note 2</sup>	w/ controller <sup>Note 3</sup>	Average <sup>Note 2</sup>	w/ controller <sup>Note 3</sup>
KFPVA010-2-04	10	5 or less	2 or less (at the maximum working pressure differential)	
KFPVA010-2-08				
KFPVA010-2-12				
KFPVA010-2-16				
KFPVA010-2-20				

- Note 1: Hysteresis measured under Koganei's test conditions.  
 2: w/o controller.  
 3: When KFPC1 DC24V (DIP switch (page 25) 4\_ON, 5\_ON) is used.  
 If a 12VDC model is desired, contact the sales representative or the nearest Koganei sales office.  
 4: Repeatability measured under Koganei's test conditions.

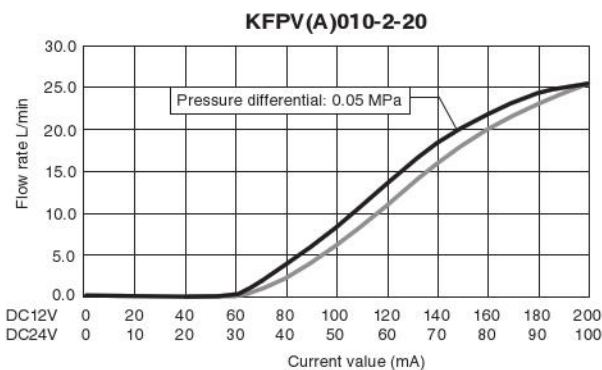
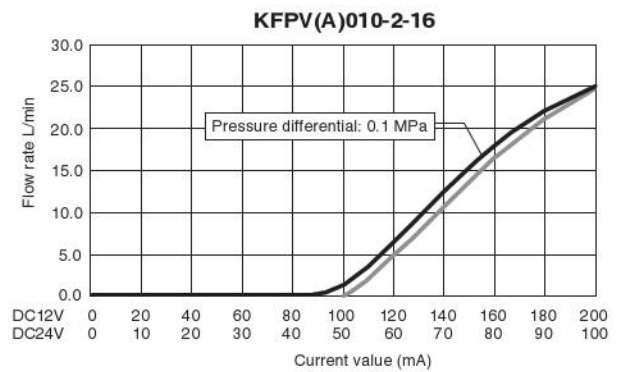
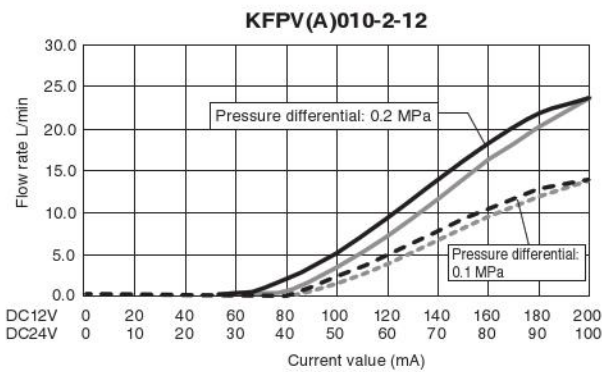
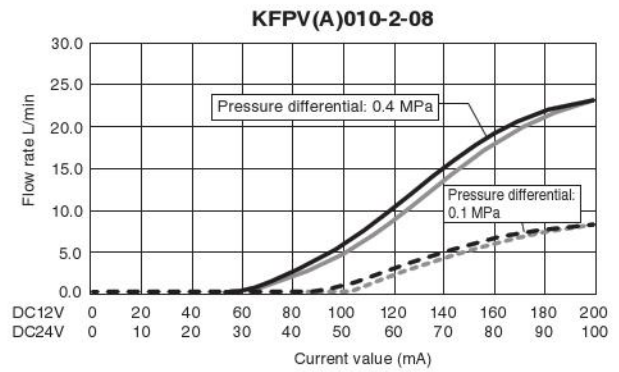
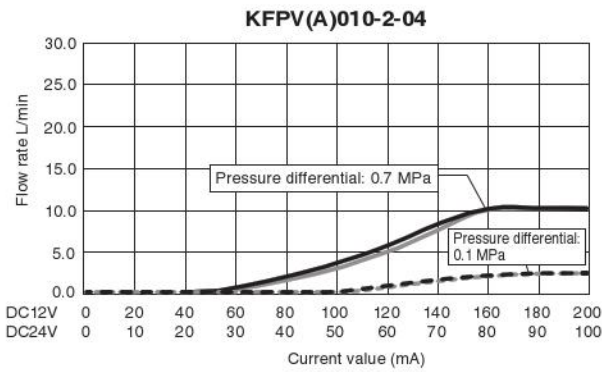

Note: No controller, media: Air.

Small proportional control valve

● KFPV010 (direct piping)

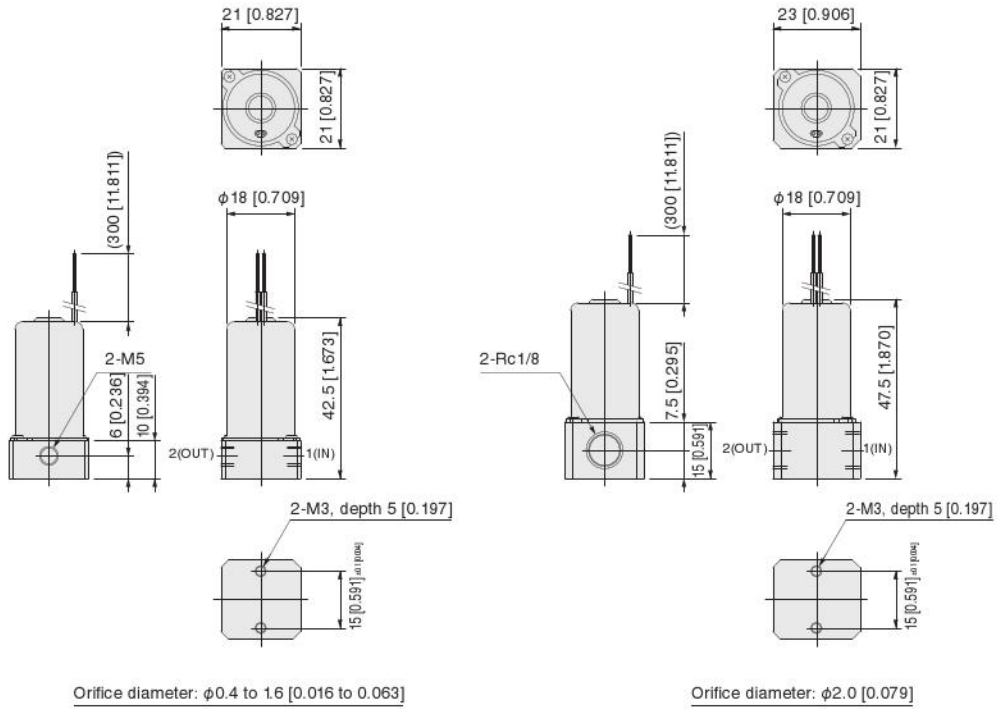

Small proportional control valve

● KFPVA010 (bottom piping)

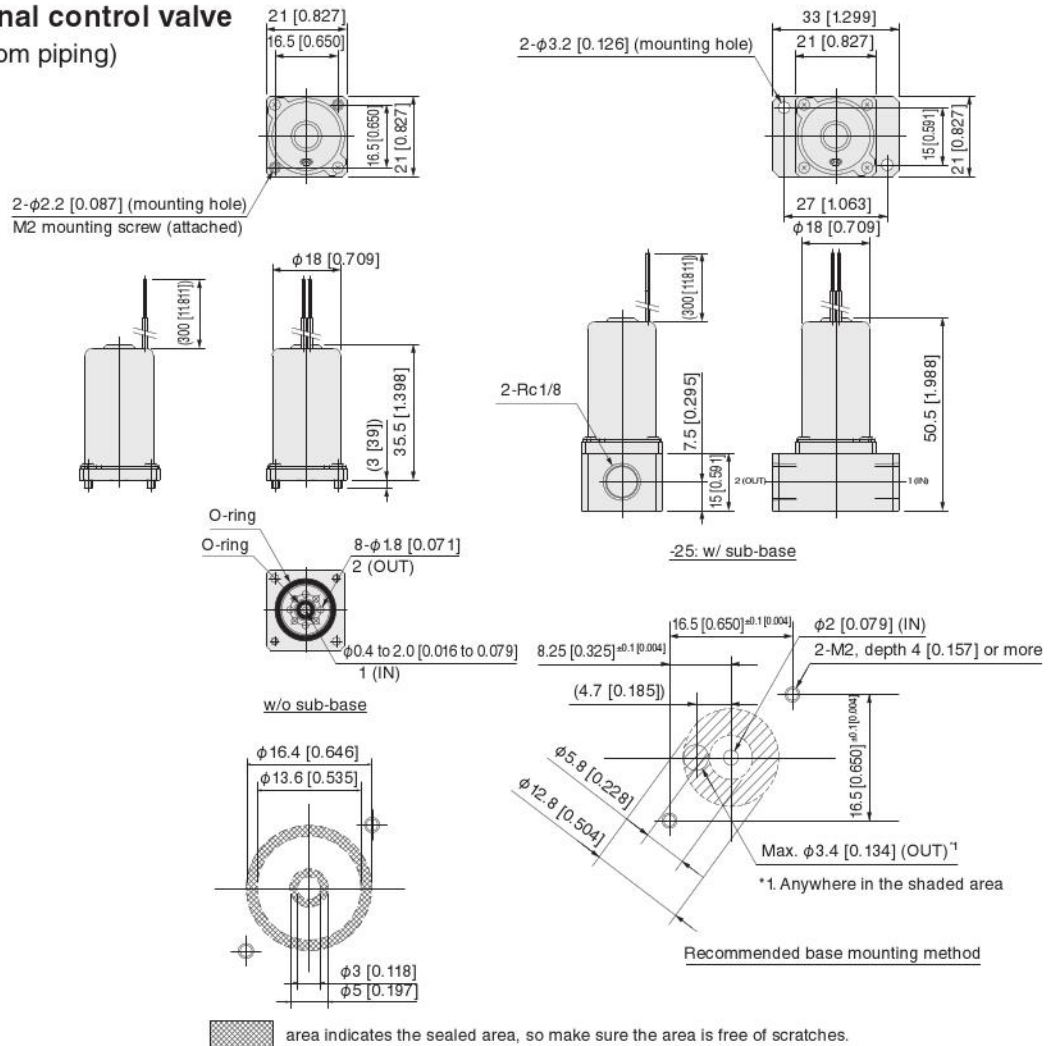



# Fluid Control Equipment Proportional Control Valve

# KFPV050·KFPV300Series

Flexibly control  
flow rate of gas  
and liquid.



KFPV010

KFPV050

KFPV300

KFPC1 Controller

ISO10993-compliant

# Fluid Control Equipment

## Proportional Control Valve KFPV050·KFPV300 Series

In combination with a dedicated controller, KFPV050 Series and KFPV300 Series make it possible to seamlessly adjust the flow rate and accurately control various media, including gases and liquids, by changing the magnitude of the input signal.

- **KFPV050 Series and KFPV300 Series can control the flow rates of gas and liquid, offering *dual* functions with a *single* unit.**
- **High accuracy, high quality, and high response.**

In combination with the KFPC1 controller, KFPV050 Series and KFPV300 Series provide the following high-level specifications (under Koganei's test conditions): repeatability 2% F.S. or less; response accuracy 2% F.S. or less; and low hysteresis 5%F.S. or less.

### Proportional Control Valve KFPV300 Series

Rc3/8, Rc1/2<sup>Note</sup> Direct Acting 2-port Valve, Plunger type

Note: The port size depends on the orifice diameter.

**Large flow rate!**

KFPV300 Series can control an air flow rate about six times<sup>Note</sup> greater than KFPV050 Series.

Note: Under Koganei's measurement conditions.



(Body material: SCS13 (equivalent to SUS304))

### Proportional Control Valve KFPV050 Series

Rc1/4 Direct Acting 2-port Valve, Plunger type



(Body material: SUS304)

(Body material: Brass)

#### Flexible wiring

Flexible wiring is possible according to the mounting conditions, offering more flexible design.



● The wiring direction can be adjusted in increments of 90° (up, down, right, and left).

KFPV050 Series



KFPV300 Series



● The direction of the solenoid can also be adjusted in any direction.



KFPV050 Series



KFPV300 Series

90° increments  
**360°**



**Caution**

Read the safety precautions on page 3 before using this product.

# Proportional control valve controller KFPC1

## ■ Equipped with an Initial setting support circuit!

This circuit enables initial setting without external inputs.

## ■ Highly reliable controller

- Reference input signal 4 to 20 mA, 0 to 10 V.
- In order to mitigate wide fluctuations in the reference input signal, the ramp response time can be adjusted within a range of 0 to 10 seconds.
- Monitor signals are used to make settings and display the solenoid current.
- Zero-point switch-off function completely seals the valve.
- Built-in temperature compensation circuit.
- With two potentiometers, it is possible to set valve opening points and fully open flow rate values to match usage conditions.
- LED monitor.



## Example connection circuit configuration

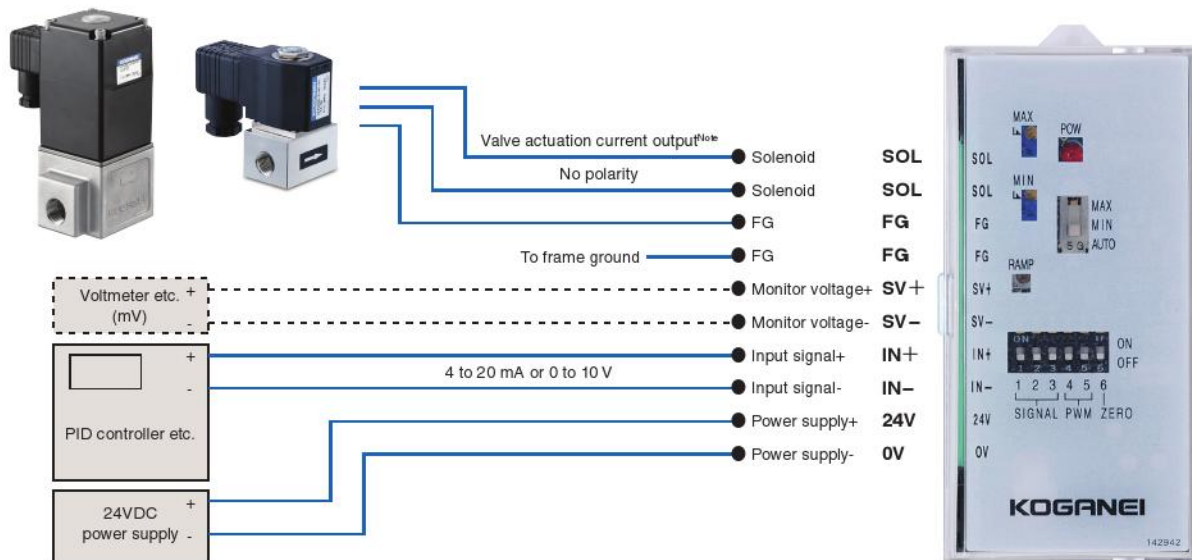

Note: For information about valve actuation current values (reference values), refer to the instruction manual that comes with the controller.

Proportional control valve controller KFPC1

## Applicable examples

### ● Water flow rate control

KFPV050 Series and KFPV300 Series enable seamless control of the flow rate with varying magnitudes of input signal.

Now a single control valve can perform multiple-level flow control that normally requires multiple ON/OFF type solenoid valves.



### ● 2-liquid mixture

Mixes liquids A & B at a constant rate.



### ● Other

- Cylinder speed control.
- Automatic adjustment of ionizer air flow rate in accordance with workpiece type and size.

# Proportional Control Valve KFPV050 Series

Rc1/4 Direct Acting 2-port Valve,  
Plunger type

Use the proportional control valve in combination with the KFPC1 controller.

For details on the controller, refer to page 25.



## Symbol

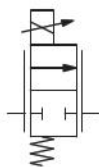

Normally closed (NC)

## Basic Models and Functions

Item	Model	KFPV050
Number of positions		2 positions
Number of ports		2 ports
Circuit configuration		Normally closed (NC)

## General Specifications

Item	Basic type	KFPV050
Medium <sup>Note 1</sup>		Air, neutral gas, water (other gases and liquids that do not affect component parts)
Seal material		FKM
Body material		Brass or stainless steel
Temperature range for the medium used	°C [°F]	-10 to 90 [14 to 194] (non-freezing)
Operating method		Direct acting type
Ambient temperature range (ambient atmosphere)	°C [°F]	0 to 55 [32 to 131]
Medium viscosity	m <sup>2</sup> /s	21 × 10 <sup>-6</sup> or less
Mounting direction <sup>Note 2</sup>		Any
Protection level		IP65 or equivalent

Note 1: For information about component part materials, refer to "Internal Configuration and Materials of Major Parts" on page 20.

2: Mounting with the solenoid facing upwards is recommended in order to avoid accumulation of contaminants, etc.

## Detailed Specifications

### ● Seal material: FKM

Item	Port size	Orifice diameter <sup>Note 1</sup> φ (mm [in.])	Flow rate			Working pressure differential range <sup>Note 2</sup> (MPa [psi])	Proof pressure (MPa [psi])	Rated voltage <sup>Note 3</sup>	Power consumption (W)	Coil current (MAX: mA)	Mass (g [oz])
			Cv value	C value	Effective cross-sectional area (mm <sup>2</sup> )						
KFPV050-2-20	Rc1/4	2.0 [0.079]	0.13	0.46	2.3 [42.435]	0 to 0.7 [0 to 102]	3.5 [508]	DC24V	8	300	550 [19.40]
KFPV050-2-30	Rc1/4	3.0 [0.118]	0.22	0.80	4.0 [73.800]	0 to 0.35 [0 to 51]					
KFPV050-2-40	Rc1/4	4.0 [0.157]	0.31	1.14	5.7 [105.2]	0 to 0.2 [0 to 29]					

Note 1: For information about orifice diameter selection, refer to the flow rate conversion graphs on page 22.

2: The working pressure upper limit is the highest pressure that can be applied to the inlet side of the proportional control valve. Above this pressure, valve leaking may occur, even if it is within the working pressure differential range.

3: Allowable voltage fluctuation range: Rated voltage ±10%

4: For selection, refer to "Notes on use" on page 3.

## Internal Configuration and Materials of Major Parts

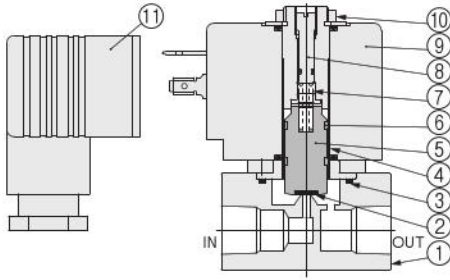

No.	Name	Material
①	Valve body	Brass or SUS304
②	Plunger seal	FKM
③	O-ring	FKM
④	Guide tube	SUS304
⑤	Plunger	Electromagnetic stainless steel
⑥	Wear ring	PTFE
⑦	Spring	SUS304
⑧	Stopper	SUS304
⑨	Solenoid	Polyester
⑩	Lock nut	Free-cutting steel (nickel plated)
⑪	DIN connector	Resin

## Characteristics

### Characteristics when used in combination with controller KFPC1

Hysteresis	%F.S.	5 or less
Repeatability	%F.S.	2 or less
Response accuracy	%F.S.	2 or less
Rangeability		10:1

Note: Measurements were taken under Koganei measurement conditions.

Note 1: The characteristic curve to the right shows actual flow rate values with a maximum flow rate of 100% measured under Koganei test conditions, relative to the control signal input % (current, voltage).

Note 2: Actual flow rate characteristics depend on usage conditions and settings conditions, so check them under actual use conditions.

### ● Characteristic Curve

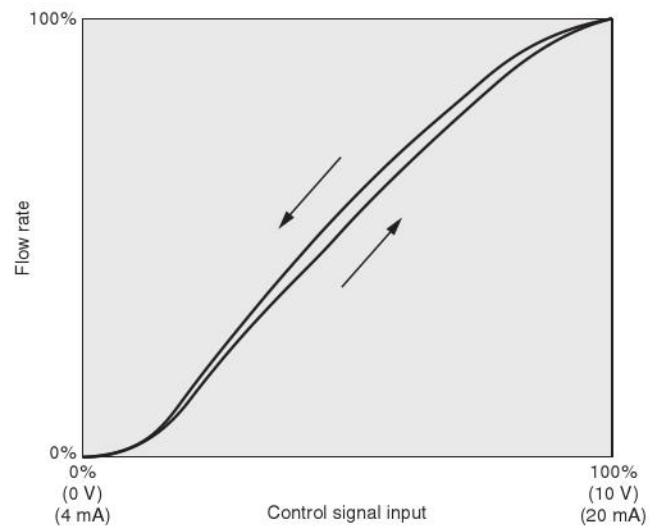

## Proportional Control Valve Order Codes

Model	Circuit configuration	Orifice diameter	Seal material	Valve body material	Port size	Wiring specifications	Voltage
KFPV050	-2: 2 ports	-20: $\phi$ 2.0 mm [0.079 in.]	-FM: FKM	-BR: Brass* -S4: SUS304	-02: Rc1/4	-39: DIN w/ connector -39N: DIN w/o connector	DC24V
		-30: $\phi$ 3.0 mm [0.118 in.]					
		-40: $\phi$ 4.0 mm [0.157 in.]					

● Controllers are sold separately and must be ordered separately.

\* -BR indicates that biological safety evaluation has not been performed as per ISO10993.

● Proportional control valve controller

**KFPC1-F07-DN DC24V**

For details, refer to page 20.



● Order codes for DIN connectors only

DIN connector standard type  
(□ 27 mm [1.063 in.]

**KFPZ-39**



**Proportional control valve**  
**KFPV050**

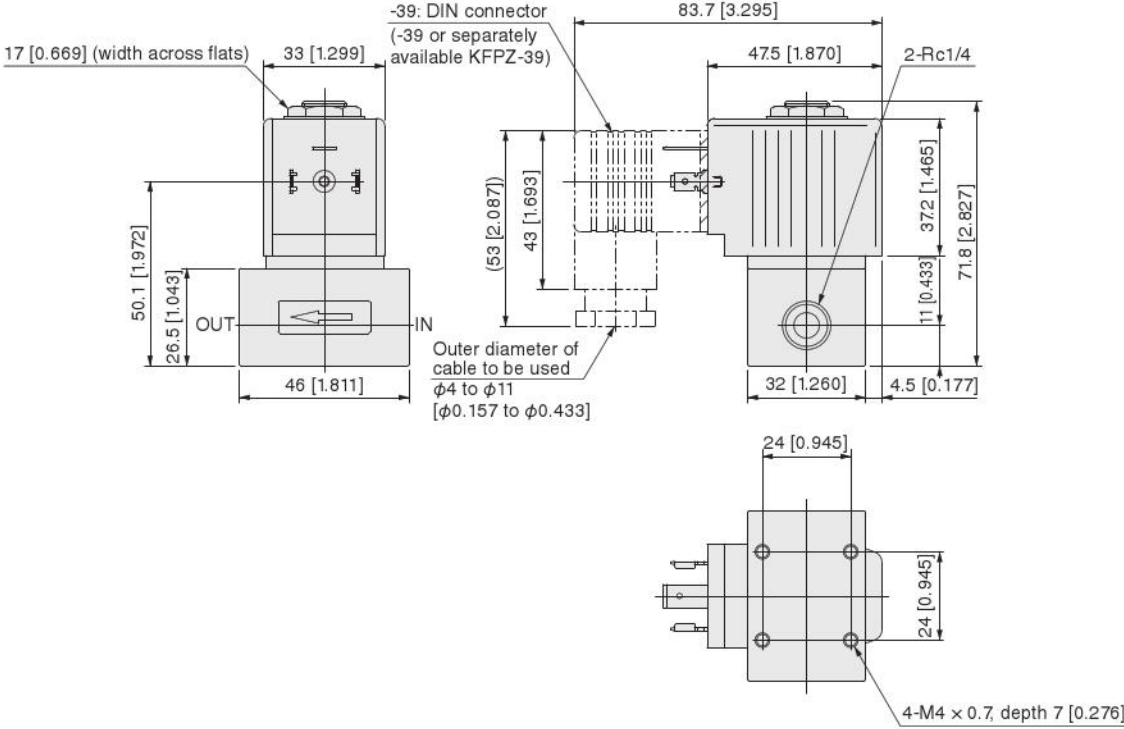

# Proportional Control Valve KFPV300 Series

Rc3/8, Rc1/2 Direct Acting 2-port Valve,  
Plunger type



Use the proportional control valve in combination with the KFPC1 controller.

For details on the controller, refer to page 25.

## Symbol

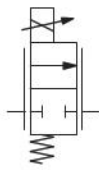

Normally closed (NC)

## Basic Models and Functions

Item	Model	KFPV300
Number of positions		2 positions
Number of ports		2 ports
Circuit configuration		Normally closed (NC)

## General Specifications

Item	Basic type	KFPV300
Medium <sup>Note 1</sup>		Air, neutral gas, water (other gases and liquids that do not affect component parts)
Seal material		FKM, EPDM
Body material		Stainless steel
Temperature range for the medium used	°C [°F]	-10 to 90 [14 to 194] (non-freezing)
Operating method		Direct acting type
Ambient temperature range (ambient atmosphere)	°C [°F]	0 to 55 [32 to 131]
Medium viscosity	m <sup>2</sup> /s	21 × 10 <sup>-6</sup> or less
Mounting direction <sup>Note 2</sup>		Any
Protection level		IP65 or equivalent

Note 1: For information about component part materials, refer to "Internal Configuration and Materials of Major Parts" on page 23.

2: Mounting with the solenoid facing upwards is recommended in order to avoid accumulation of contaminants, etc.

## Detailed Specifications

### ● Seal material: FKM, EPDM

Item	Port size	Orifice diameter <sup>Note 1</sup> φ (mm [in.])	Flow rate			Working pressure differential range <sup>Note 2</sup> (MPa [psi])	Proof pressure (MPa [psi])	Rated voltage <sup>Note 3</sup>	Power consumption (W)	Coil current (MAX: mA)	Mass (g [oz])
			Cv value	C value	Effective cross-sectional area (mm <sup>2</sup> )						
KFPV300-2-40	Rc3/8	4.0 [0.157]	0.52	1.9	9.5 [175.3]	0 to 0.8 [0 to 116]	3.5 [508]	DC24V	21	880	2200 [77.60]
KFPV300-2-60	Rc3/8	6.0 [0.236]	1.05	3.86	19.3 [356.1]	0 to 0.6 [0 to 87]					
KFPV300-2-80	Rc1/2	8.0 [0.315]	1.60	5.9	29.5 [544.3]	0 to 0.4 [0 to 58]					
KFPV300-2-100	Rc1/2	10.0 [0.394]	2.10	7.74	38.7 [714.0]	0 to 0.2 [0 to 29]					
KFPV300-2-120	Rc1/2	12.0 [0.472]	2.70	9.96	49.8 [918.8]	0 to 0.1 [0 to 15]					

Note 1: For information about orifice diameter selection, refer to the flow rate conversion graphs on page 22.

2: The working pressure upper limit is the highest pressure that can be applied to the inlet side of the proportional control valve. Above this pressure, valve leaking may occur, even if it is within the working pressure differential range.

3: Allowable voltage fluctuation range: Rated voltage ±10%

4: For selection, refer to "Notes on use" on page 5.

## Internal Configuration and Materials of Major Parts

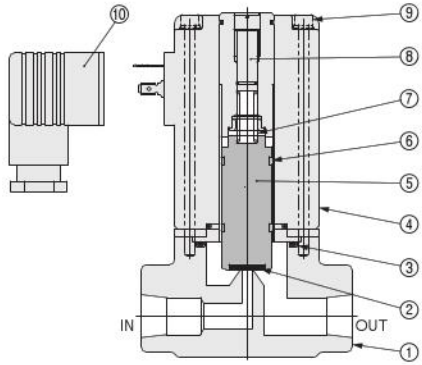

No.	Name	Material
①	Valve body	SCS13
②	Plunger seal	FKM, EPDM
③	O-ring	FKM, EPDM
④	Solenoid	Polyester
⑤	Plunger	Electromagnetic stainless steel
⑥	Wear ring	PTFE
⑦	Spring	SUS304
⑧	Stopper	Electromagnetic stainless steel
⑨	Hex socket bolt	SUS304
⑩	DIN connector	Resin

## Characteristics

### Characteristics when used in combination with controller **KFPC1**

Hysteresis	%F.S.	5 or less
Repeatability	%F.S.	1 or less
Response accuracy	%F.S.	2 or less
Rangeability		50:1

Note: Measurements were taken under Koganei measurement conditions.

Note 1: The characteristic curve to the right shows actual flow rate values with a maximum flow rate of 100% measured under Koganei test conditions, relative to the control signal input % (current, voltage).

Note 2: Actual flow rate characteristics depend on usage conditions and settings conditions, so check them under actual use conditions.

### ● Characteristic Curve

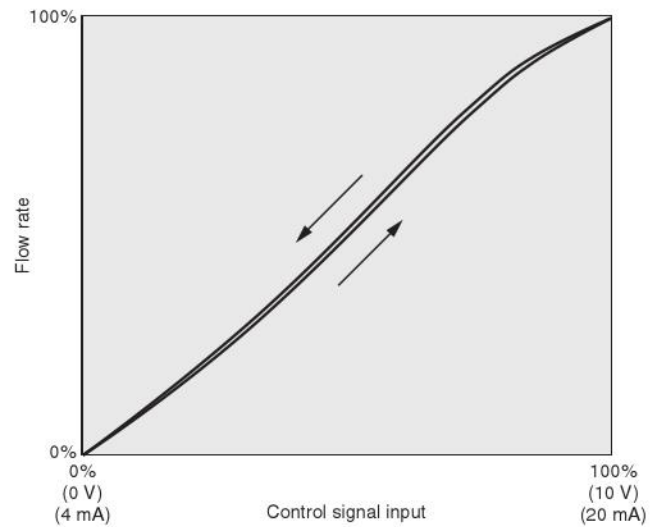

## Proportional Control Valve Order Codes

Model	Circuit configuration	Orifice diameter	Seal material	Valve body material	Port size	Wiring specifications	Voltage
KFPV300	-2	-40	-FM -AA	-S13*	-03	-39 -39N	DC24V
		-60					
		-80			-04		
		-100					
		-120					

● Controllers are sold separately and must be ordered separately.

\* -S13 indicates that biological safety evaluation has not been performed as per ISO10993. For ISO10993-compliant models, refer to page 33.

● Proportional control valve controller

**KFPC1-F07-DN DC24V**

For details, refer to page 25.



● Order codes for DIN connectors only

DIN connector standard type  
(□ 27 mm [1.063 in.]

**KFPZ-39**



**Proportional control valve**  
**KFPV300**

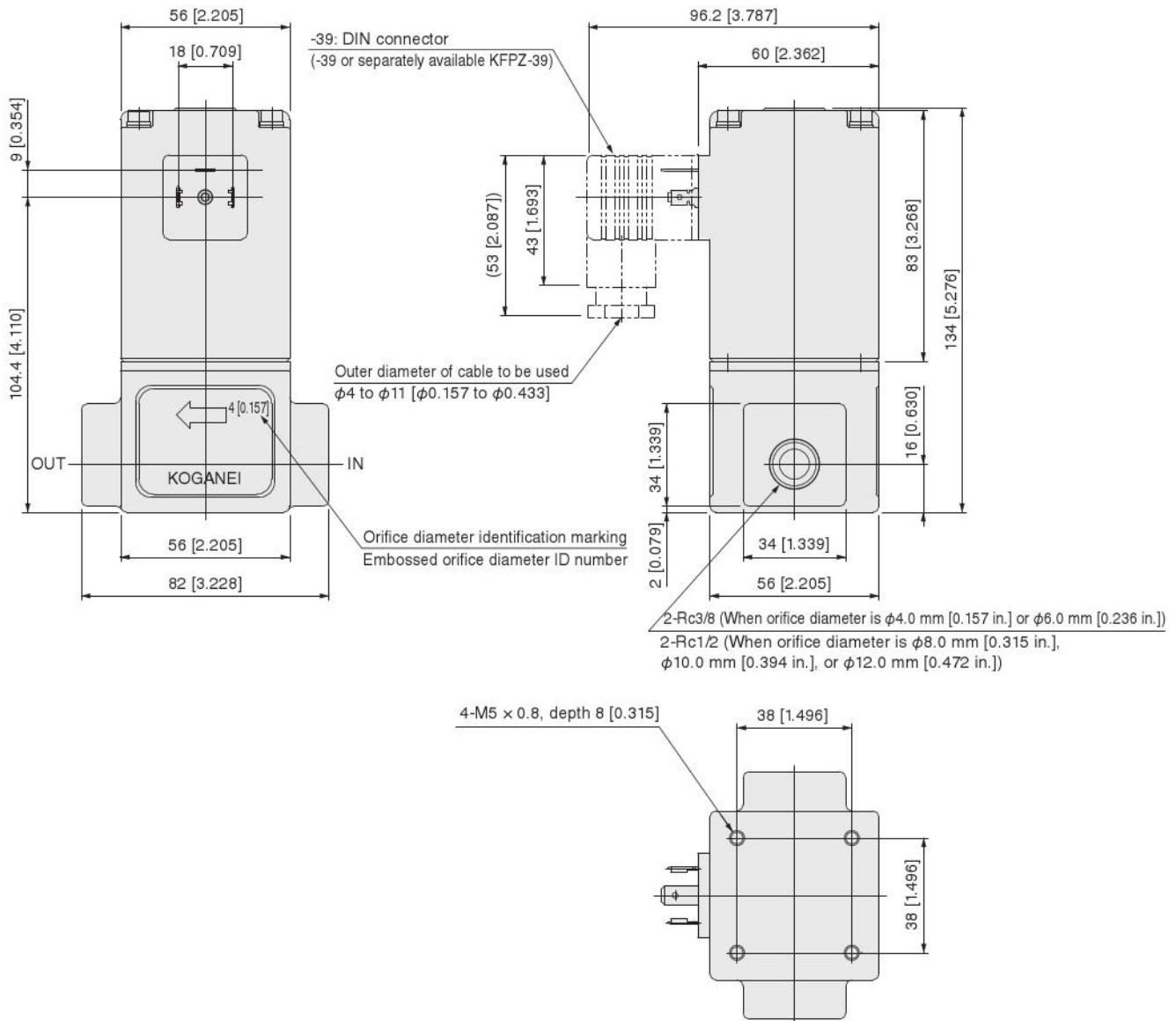

KFPV010

KFPV050

KFPV300

KFPC1 Controller

ISO10993-compliant

# Proportional Control Valve Controller KFPC1

## Specifications

Item	Model	KFPC1-F07-DN DC24V	
Mounting method		DIN rail mounting	
Signal input		4 to 20 mA	0 to 10 V
Input impedance	$\Omega$	220	1.2M
Power supply voltage		24 VDC $\pm$ 10%	
Valve control signal		PWM (pulse width modulation)	
Ambient temperature range (ambient atmosphere)	$^{\circ}\text{C}$ [ $^{\circ}\text{F}$ ]	0 to 50 [32 to 122] (no condensation)	
Maximum allowable load current	A	1.1	
Power consumption (control circuit)	W	0.55	
Monitor signal		Directly proportional to solenoid current 1 mV = 1 mA	
Ramp response time	s	0 to 10	

\* If a 12VDC model is desired, contact the sales representative or the nearest Koganei sales office.

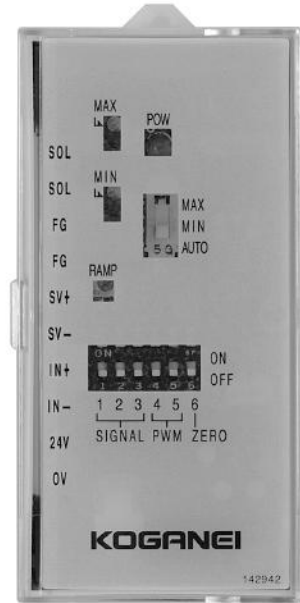

## Major Parts and Functions

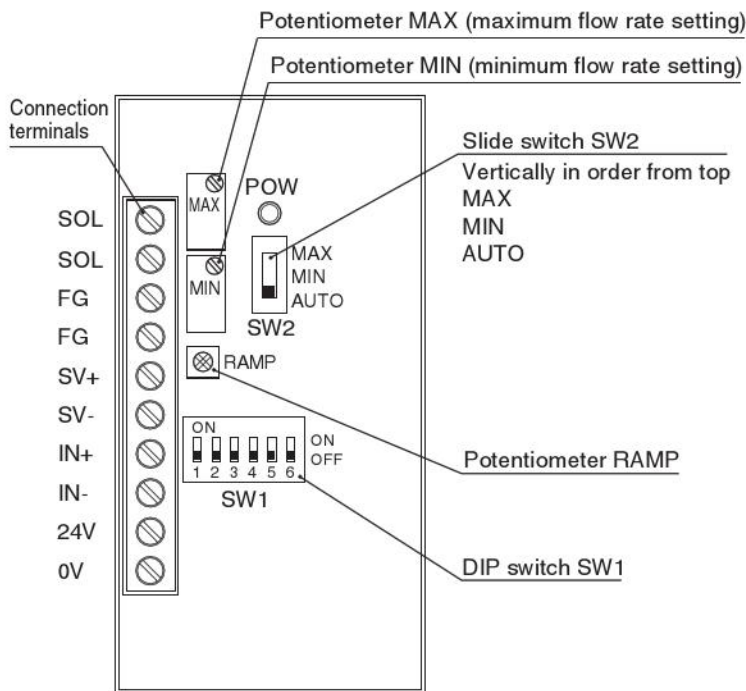

### Connection terminals

SOL	Valve actuation output (No polarity)
SOL	Valve actuation output (No polarity)
FG	Valve ground
FG	Power supply frame ground
SV+	Monitor output (+)
SV-	Monitor output (-)
IN+	Standard signal input (+)
IN-	Standard signal input (-)
24V	Power supply input (+)
0V	Power supply input (-)

### Potentiometers

MAX	For setting current value $I_2$ when valve is fully open
MIN	For setting current value $I_1$ when valve starts to open
RAMP	For setting ramp response time (0 to 10 seconds)

### LED indicator

POW	Lights up when current is flowing to the solenoid
-----	---

### DIP switches

SW1	
1 to 3 (SIGNAL)	Selects standard signal input (4 to 20 mA, 0 to 10 V)
4, 5 (PWM)	Switches between PWM frequencies
6 (ZERO)	Sets the zero point off function switch

### Slide switches

SW2	
MAX	Input signal MAX
MIN	Input signal MIN
AUTO	Input signal AUTO (operation mode)

### ● Proportional control valve controller order codes

**KFPC1-F07-DN DC24V**



## ⚠ Important!

For proper operation of a proportional control valve, be sure to configure initial settings before use. (Potentiometer MIN/MAX adjustment required.) For details, refer to the instruction manual.

**Proportional control valve controller**  
**KFPC1-F07-DN**

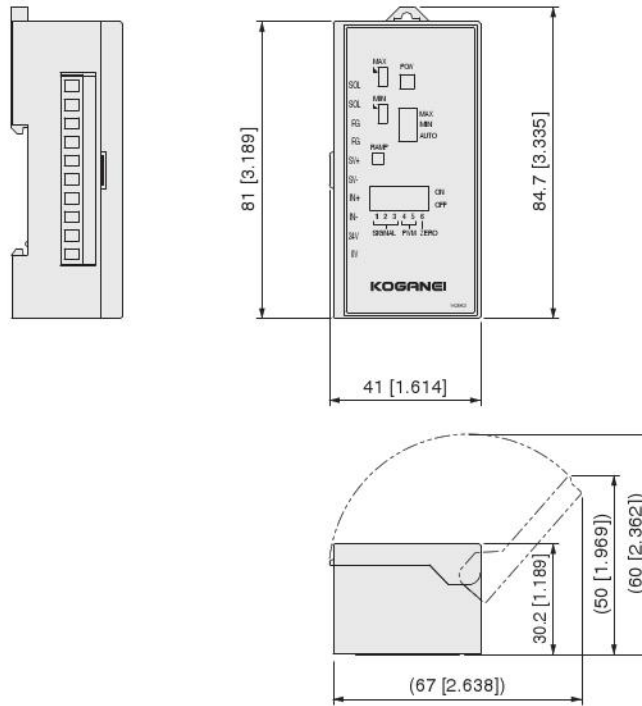

Note: For instructions about handling the controller, refer to the instruction manual that comes with the product.

KFPV010

KFPV050

KFPV300

KFPC1 Controller

ISO10993-compliant

● Water flow rate conversion graph

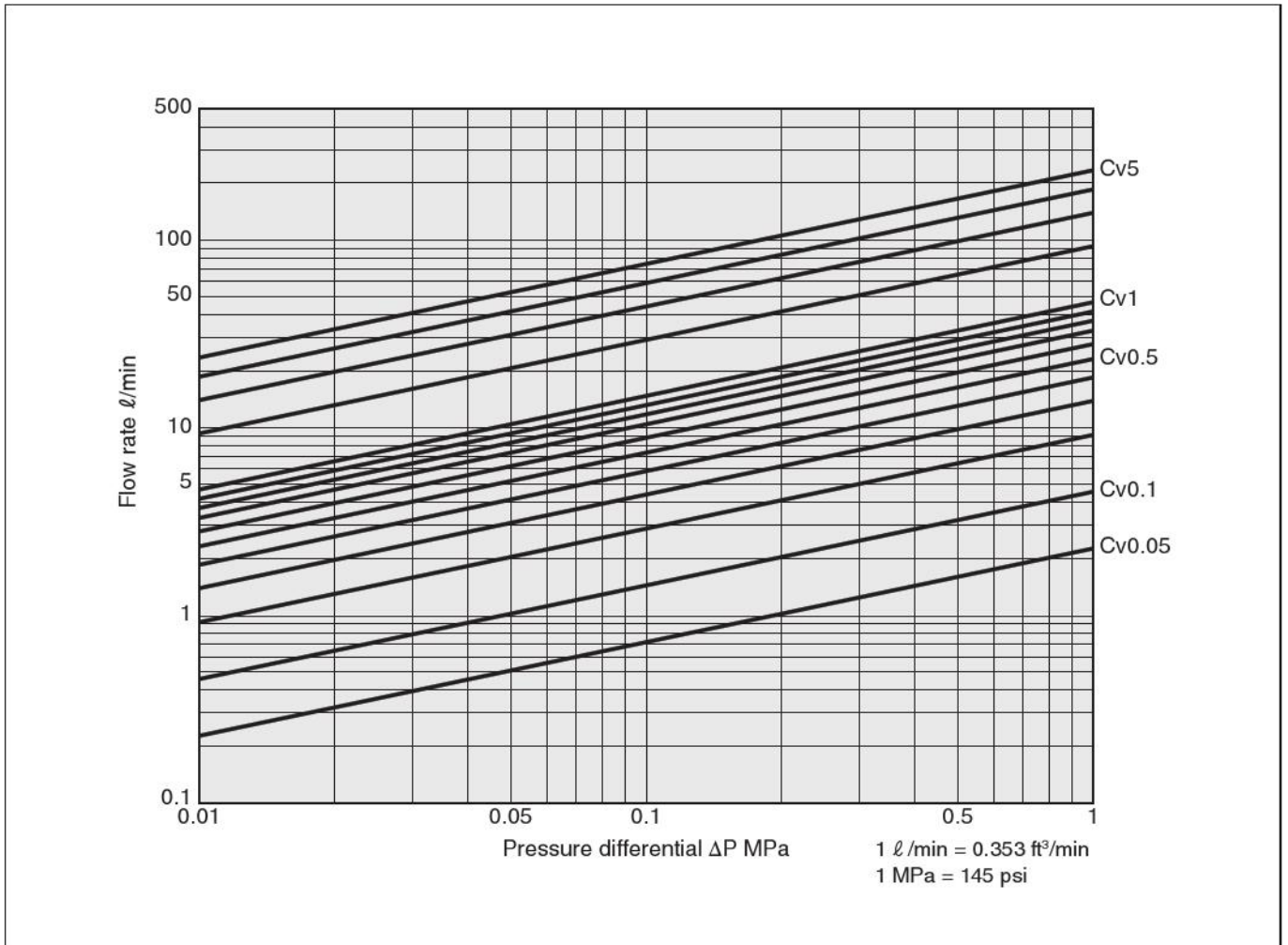

Note: Pressure differential  $\Delta P$  in the graph indicates the difference between primary side (upstream) gauge pressure  $P_1$  and secondary side (downstream) gauge pressure  $P_2$ .  
 $\Delta P = P_1 - P_2$  (MPa [psi])

**Flow rate calculation formula** (Pressures  $P_h$  and  $P_l$  in the formula indicate absolute pressure.)

$$Q = 45.62 C_v \frac{\sqrt{P_h - P_l}}{\sqrt{G}}$$

- $Q$ : Flow rate  $l/min$
- $C_v$ : Flow rate coefficient
- $P_h$ : Primary side (upstream) absolute pressure MPa
- $P_l$ : Secondary side (downstream) absolute pressure MPa
- $G$ : Specific gravity (1 in the case of water)

**Using the graph**

If there is no line for the flow coefficient ( $C_v$ ) of the valve being used: Read the flow rate at  $C_v = 1$  in the graph, and then multiply it by the  $C_v$  value of the valve to be used to calculate the flow rate.

Example: Flow rate read from the graph as  $C_v = 1$ :  $Q = 20\ l/min$  [0.706  $ft^3/min$ ]  
 When the flow coefficient of the valve used is  $C_v = 0.3$   
 Calculated flow rate =  $Q \times C_v = 20 [0.706] \times 0.3 = 6.0\ l/min$  [0.212  $ft^3/min$ ]

● Air flow rate conversion graph Cv value = 1

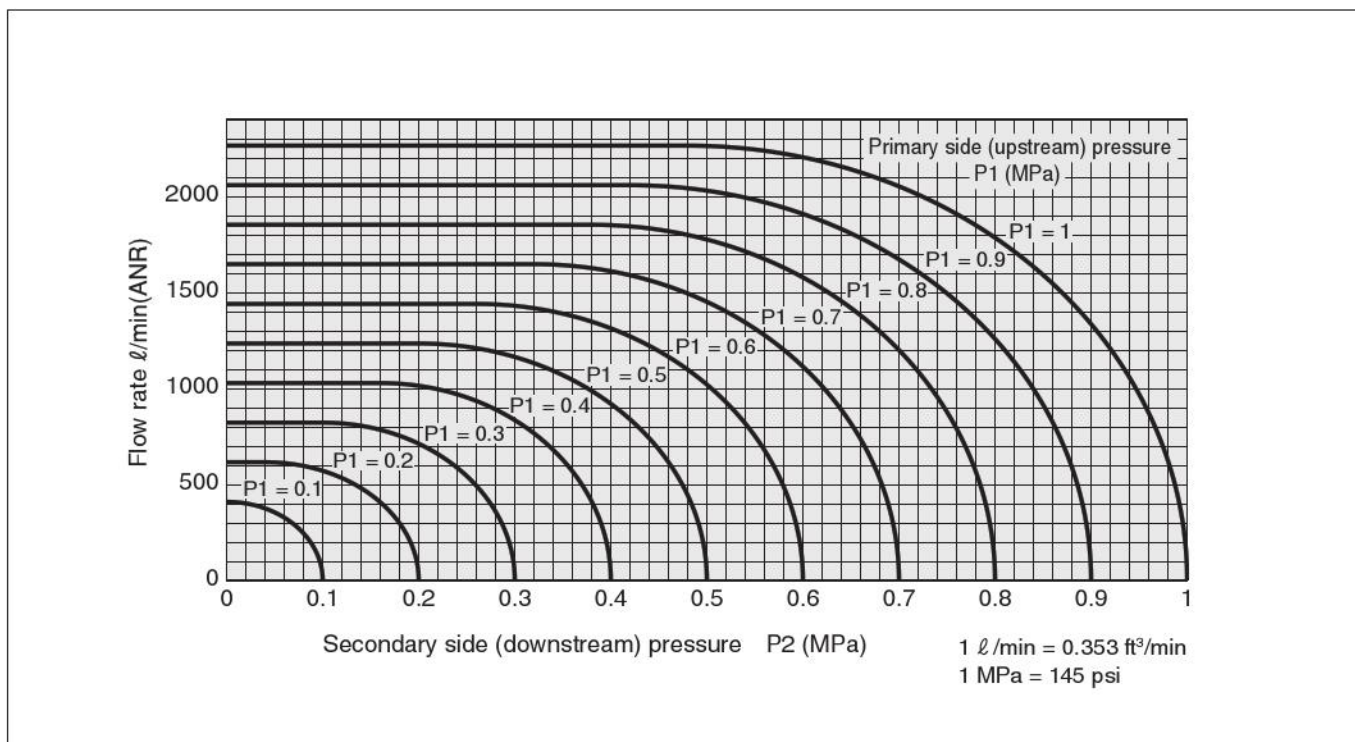

Note: Pressures P1 and P2 in the graph indicate gauge pressure (MPa [psi]).

**Flow rate calculation formula** (Pressures Ph and Pl in the formula indicate absolute pressure.)

1) When  $Pl / Ph > 0.5283$

$$Q = 4119 C_v \frac{\sqrt{(P_h - P_l) P_l}}{\sqrt{G}}$$

2) When  $Pl / Ph \leq 0.5283$

$$Q = 2056 C_v P_h \frac{1}{\sqrt{G}}$$

- Q: Flow rate l /min (ANR)
- Cv: Flow rate coefficient
- Ph: Primary side (upstream) absolute pressure MPa
- Pl: Secondary side (downstream) absolute pressure MPa
- G: Specific gravity (Specific gravity with air being 1)

**Using the graph**

The above graph shows the flow rate when the flow coefficient Cv = 1. When Cv ≠ 1, multiply the flow rate read from the graph by the Cv value of the valve to be used to calculate the flow rate.

Example: Flow rate read from the graph: Q = 500 l/min (ANR) [17.660 ft³/min]  
 When the flow coefficient of the valve used is Cv = 0.3  
 Calculated flow rate = Q × Cv = 500 [17.660] × 0.3 = 150 l/min (ANR) [5.298 ft³/min]

● Flow rate calculation software can be downloaded from the Koganei website. Use it for product selection.

## Explanation of Terms

### ● Working pressure differential

Difference between input side pressure and output side pressure that can operate a proportional control valve.

### ● Working pressure differential range

Range between the working pressure differential upper limit (maximum working pressure differential) and lower limit (minimum working pressure differential).

### ● Proof pressure

Pressure that must be withstood when returning to the maximum working pressure, without causing a drop in performance. This pressure is a value subject to specification conditions.

### ● Power consumption

In the case of DC power, the product of the DC voltage and the DC effective current, represented in Watt (W).

### ● Cv value

One of the capacity coefficients. Value in US gal (U.S. gallons)/minute, expressing the flow rate of tap water with a temperature of 60°F (15.5°C) flowing through the valve when pressure differential is 1 lbf/in<sup>2</sup> (1 psi).

### ● Orifice diameter

Diameter of a circular, cross-sectional area that is converted from the cross-sectional area of the constricted location where the valve flow path is narrowest and the length is relatively shorter than the cross section dimension.

### ● Viscosity

Index that expresses internal friction that accompanies medium flow. There is also absolute viscosity to differentiate from kinetic viscosity.

### ● Kinetic viscosity

Medium viscosity  $\eta$  divided by density  $\rho$  of the medium under the same conditions (temperature, pressure), which results in  $\gamma = \eta / \rho$  and expresses the amount of resistance when the medium flows when acted upon by gravity.

Normally, cSt (centistokes) is used as the unit of kinetic viscosity, and in the SI unit system, m<sup>2</sup>/s (square meters per second) is used. In addition to these units, St (stokes) is used. For example, m<sup>2</sup>/s (square meters per second) means a medium kinetic viscosity of N•S/m<sup>2</sup> (Newton seconds per square meter) at a density of 1 kg/m<sup>3</sup>.

The table below shows how to convert between units.

m <sup>2</sup> /s	St	cSt
1	1×10 <sup>4</sup>	1×10 <sup>6</sup>
1×10 <sup>-4</sup>	1	1×10 <sup>2</sup>
1×10 <sup>-6</sup>	1×10 <sup>-2</sup>	1

### ● Hysteresis

Characteristic of a device whose output value depends upon the direction of an applied input value.

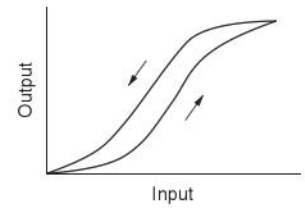

### ● Ramp response

Time response of transition from an invariable input state to a state that changes at a fixed speed.

### ● Ramp response time

For ramp response, the time it takes until the value produced by subtracting the primary steady-state error of the output from the value produced by multiplying the input by the static gain falls within the specified allowable range (for example, ±5%).

### ● Pulse width modulation (PWM)

A signal with a frequency band of F [Hz] is fully determined based on the value of signal sampled at intervals of 1/2F [S] (sampling theorem). There are various methods to express all the information of a sampled modulation signal (such as audio) as a pulse stream based on this theorem, which is called "pulse modulation." The method that modifies the sample value amplitude information in the sampled modulation signal by a pulse width with a constant amplitude is called "pulse width modulation."

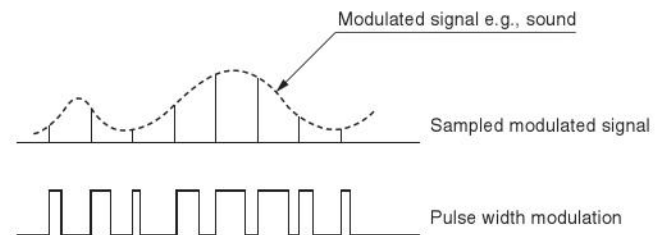

### ● PID control (P: Proportional action I : Integral action D: Derivative action)

PIC control consists of three different control actions: proportional action (P action), where the output of the controller is proportional to the input; integral action (I action), where the output is proportional to the integral of the input; and derivative action (D action), where the output is proportional to the derivative of the input.

### ● Rangeability

Ratio of the controllable maximum and minimum flow coefficients (Cv values). When rangeability is 10:1, for example, the minimum flow coefficient Cv value is 1.0 for a maximum flow coefficient Cv value of 10.0.

### ● Temperature compensation

Normally, electrical components have varying current and voltage levels in response to changes in temperature or due to the heat generated by themselves, which is a characteristic of electrical components called "temperature drift." Temperature drift compensation is called "temperature compensation."

KFPV010

KFPV050

KFPV300

KFPC1 Controller

ISO10993-compliant

# Fluid Control Equipment Proportional Control Valve KFPV Series



**The biological safety has been verified as per ISO10993\*.**

**[Evaluated items]**

- Cell toxicity testing
- Sensitization testing
- Irritation testing

\* ISO10993 (Biological evaluation of medical devices) is conducted as part of verification work in the risk management process as per ISO14971 (Medical devices -- Application of risk management to medical devices). This product has been verified with respect to its safety according to ISO10993.

## Specifications

### ● Proportional control valve

Item	Basic type	KFPV(A)010	KFPV050	KFPV300
	Medium	Air, neutral gas, water (other gases and liquids that do not affect component parts)	Air, oxygen, water (other gases and liquids that do not affect component parts)	
Seal material	FKM			
Body material	Stainless steel			
Temperature range for the medium used °C [°F]	0 to 55 [0 to 131]		-10 to 90 [14 to 194] (non-freezing)	
Operating method	Direct acting type			
Ambient temperature range (ambient atmosphere) °C [°F]	0 to 55 [32 to 131]			
Medium viscosity m <sup>2</sup> /s	1 × 10 <sup>-6</sup> or less		21 × 10 <sup>-6</sup> or less	
Mounting direction <sup>Note 1</sup>	Any <sup>Notes 1 and 2</sup>		Any <sup>Note 1</sup>	
Protection level	IP40 or equivalent		IP65 or equivalent	

Note 1: Mounting with the solenoid facing upwards is recommended in order to avoid accumulation of contaminants, etc.

2: When using the product at a pressure close to the maximum working pressure, install it with the solenoid facing upwards.

## Detailed Specifications

### ● Direct piping type

Item	Port size	Orifice diameter <sup>Note 1</sup> φ (mm [in.])	Flow rate			Working pressure differential range <sup>Note 2</sup> (MPa [psi])	Proof pressure (MPa [psi])
			Cv value	C value	Effective cross-sectional area		
Model							
KFPV010-2-04	M5	0.4 [0.016]	0.006	0.02	0.1 [1.845]	0 to 0.7 [0 to 102]	1.05 [152]
KFPV010-2-08		0.8 [0.031]	0.02	0.07	0.35 [6.458]	0 to 0.4 [0 to 58]	
KFPV010-2-12		1.2 [0.047]	0.035	0.13	0.65 [11.993]	0 to 0.2 [0 to 29]	
KFPV010-2-16		1.6 [0.063]	0.06	0.21	1.05 [19.373]	0 to 0.1 [0 to 15]	
KFPV010-2-20	Rc1/8	2 [0.079]	0.075	0.27	1.35 [24.908]	0 to 0.05 [0 to 7]	

Item	Hysteresis (%) <sup>Note 3</sup>		Power supply used (V)	Power consumption (W)	Resistance (Ω)	Coil current <sup>Note 6</sup> (mA)	Mass (g [oz])
	Average <sup>Note 4</sup>	w/ controller <sup>Note 5</sup>					
Model							
KFPV010-2-04	10	5 or less	DC12V DC24V	0 to 2.1	DC12V: 51 DC24V: 210	DC12V: 0 to 200 DC24V: 0 to 100	77 [2.72]
KFPV010-2-08							
KFPV010-2-12							
KFPV010-2-16							
KFPV010-2-20							

### ● Bottom piping type

Item	Port size	Orifice diameter <sup>Note 1</sup> φ (mm [in.])	Flow rate			Working pressure differential range <sup>Note 2</sup> (MPa [psi])	Proof pressure (MPa [psi])
			Cv value	C value	Effective cross-sectional area		
Model							
KFPVA010-2-04	Rc1/8 (w/ sub-base)	0.4 [0.016]	0.006	0.02	0.1 [1.845]	0 to 0.7 [0 to 102]	1.05 [152]
KFPVA010-2-08		0.8 [0.031]	0.02	0.07	0.35 [6.458]	0 to 0.4 [0 to 58]	
KFPVA010-2-12		1.2 [0.047]	0.035	0.13	0.65 [11.993]	0 to 0.2 [0 to 29]	
KFPVA010-2-16		1.6 [0.063]	0.06	0.21	1.05 [19.373]	0 to 0.1 [0 to 15]	
KFPVA010-2-20		2 [0.079]	0.075	0.27	1.35 [24.908]	0 to 0.05 [0 to 7]	

Item	Hysteresis (%) <sup>Note 3</sup>		Power supply used (V)	Power consumption (W)	Resistance (Ω)	Coil current <sup>Note 6</sup> (mA)	Mass (g [oz])
	Average <sup>Note 4</sup>	w/ controller <sup>Note 5</sup>					
Model							
KFPVA010-2-04	10	5 or less	DC12V DC24V	0 to 2.1	DC12V: 51 DC24V: 210	DC12V: 0 to 200 DC24V: 0 to 100	53 [1.87] (w/ sub-base: 122 [4.30])
KFPVA010-2-08							
KFPVA010-2-12							
KFPVA010-2-16							
KFPVA010-2-20							

Note 1: For information about orifice diameter selection, refer to the graphs on page 13.

2: The working pressure upper limit is the highest pressure that can be applied to the inlet side of the proportional control valve. Above this pressure, valve leaking may occur, even if it is within the working pressure differential range.

3: Hysteresis measured under Koganei's test conditions.

4: w/o controller.

5: When KFPC1 DC24V (DIP switch (page 25) 4\_ON, 5\_ON) is used.

If a 12VDC model is desired, contact the sales representative or the nearest Koganei sales office.

6: If the product is continuously energized with the maximum current, be sure to keep the medium flowing, as the temperature rises significantly due to increased coil temperature.

## Detailed Specifications

### ● Seal material: FKM

Item Model	Port size	Orifice diameter <sup>Note 1</sup> φ (mm [in.])	Flow rate			Working pressure differential range <sup>Note 2</sup> (MPa [psi])	Proof pressure (MPa [psi])	Rated voltage <sup>Note 3</sup>	Power consumption (W)	Coil current (MAX: mA)	Mass (g [oz])
			Cv value	C value	Effective cross-sectional area (mm <sup>2</sup> )						
KFPV050-2-20	Rc1/4	2.0 [0.079]	0.13	0.46	2.3 [42.435]	0 to 0.7 [0 to 102]	3.5 [508]	DC24V	8	300	550 [19.40]
KFPV050-2-30	Rc1/4	3.0 [0.118]	0.22	0.80	4.0 [73.800]	0 to 0.35 [0 to 51]					
KFPV050-2-40	Rc1/4	4.0 [0.157]	0.31	1.14	5.7 [105.2]	0 to 0.2 [0 to 29]					

### ● Seal material: FKM

Item Model	Port size	Orifice diameter <sup>Note 1</sup> φ (mm [in.])	Flow rate			Working pressure differential range <sup>Note 2</sup> (MPa [psi])	Proof pressure (MPa [psi])	Rated voltage <sup>Note 3</sup>	Power consumption (W)	Coil current (MAX: mA)	Mass (g [oz])
			Cv value	C value	Effective cross-sectional area (mm <sup>2</sup> )						
KFPV300-2-40	Rc3/8	4.0 [0.157]	0.52	1.9	9.5 [175.3]	0 to 0.8 [0 to 116]	3.5 [508]	DC24V	21	880	2200 [77.60]
KFPV300-2-60	Rc3/8	6.0 [0.236]	1.05	3.86	19.3 [356.1]	0 to 0.6 [0 to 87]					
KFPV300-2-80	Rc1/2	8.0 [0.315]	1.60	5.9	29.5 [544.3]	0 to 0.4 [0 to 58]					
KFPV300-2-100	Rc1/2	10.0 [0.394]	2.10	7.74	38.7 [714.0]	0 to 0.2 [0 to 29]					
KFPV300-2-120	Rc1/2	12.0 [0.472]	2.70	9.96	49.8 [918.8]	0 to 0.1 [0 to 15]					

Note 1: For information about orifice diameter selection, refer to the flow rate conversion graphs on page 27②.

2: The working pressure upper limit is the highest pressure that can be applied to the inlet side of the proportional control valve. Above this pressure, valve leaking may occur, even if it is within the working pressure differential range.

3: Allowable voltage fluctuation range: Rated voltage±10%

4: For selection, refer to "Notes on use" on page 7① and perform adequate evaluation prior to use.

## Controller Specifications

Item	Model	KFPC1-F07-DN DC24V	
Mounting method		DIN rail mounting	
Signal input		4 to 20 mA	0 to 10 V
Input impedance	Ω	220	1.2M
Power supply voltage		24 VDC±10%	
Valve control signal		PWM (pulse width modulation)	
Ambient temperature range (ambient atmosphere) °C [°F]		0 to 55 [32 to 131] (no condensation)	
Maximum allowable load current	A	1.1	
Power consumption (control circuit)	W	0.55	
Monitor signal		Directly proportional to solenoid current 1 mV = 1 mA	
Ramp response time	s	0 to 10	

## Internal Configuration and Materials of Major Parts

### ● KFPV300

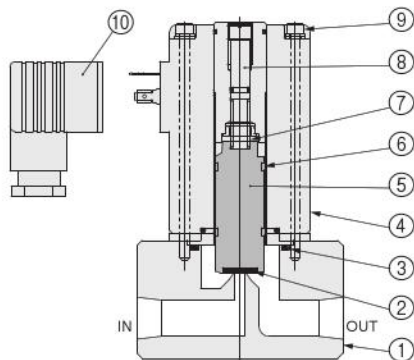

No.	Name	Material
①	Valve body	SUS304
②	Plunger seal	FKM
③	O-ring	FKM
④	Solenoid	Polyester
⑤	Plunger	Electromagnetic stainless steel
⑥	Wear ring	PTFE
⑦	Spring	SUS304
⑧	Stopper	SUS304
⑨	Hex socket bolt	SUS304
⑩	DIN connector	Resin

\* Refer to page 12② for KFPV(A)010 and page 20② for KFPV050.

## Order codes

### ● KFPV(A)010

		Circuit configuration	Orifice diameter	Seal material	Valve body material	Port size	Sub-base	Voltage
		-2: 2 ports	-04: $\phi$ 0.4 mm [0.016 in.] -08: $\phi$ 0.8 mm [0.031 in.] -12: $\phi$ 1.2 mm [0.047 in.] -16: $\phi$ 1.6 mm [0.063 in.] -20: $\phi$ 2.0 mm [0.079 in.]	-FM: FKM	-S4: SUS304	Orifice diameter: $\phi$ 0.4 [0.016], $\phi$ 0.8 [0.031], $\phi$ 1.2 [0.047], $\phi$ 1.6 [0.063] -M5: M5  Orifice diameter: $\phi$ 2.0 [0.079] -01: Rc1/8	Blank: w/o sub-base -25: w/ sub-base	DC12V DC24V
		Basic format						
KFPV010 (direct piping)	-2	-04	-FM	-S4	-M5	Blank	DC12V DC24V	
		-08						
		-12						
		-16						
		-20						
KFPVA010 (bottom piping)	-2	-04	-FM	-S4	Blank	-25	DC12V DC24V	
		-08						
		-12						
		-16						
		-20						

### ● KFPV050and KFPV300

		Circuit configuration	Orifice diameter	Seal material	Valve body material	Port size	Wiring specifications	Voltage
		-2: 2 ports	-20: $\phi$ 2.0 mm [0.079 in.] -30: $\phi$ 3.0 mm [0.118 in.] -40: $\phi$ 4.0 mm [0.157 in.] -60: $\phi$ 6.0 mm [0.236 in.] -80: $\phi$ 8.0 mm [0.315 in.] -100: $\phi$ 10.0 mm [0.394 in.] -120: $\phi$ 12.0 mm [0.472 in.]	-FM: FKM	-S4: SUS304	-02: Rc1/4 -03: Rc3/8 -04: Rc1/2	-39: DIN w/ connector -39N: DIN w/o connector	DC24V
		Model						
KFPV050	-2	-20	-FM	-S4	-02	Blank	DC24V	
		-30						
		-40						
KFPV300	-2	-40	-FM	-S4	-03	-39 -39N	DC24V	
		-60						
		-80						
		-100						
		-120						
-04								

● Controllers are sold separately and must be ordered separately.

● Proportional control valve controller

**KFPC1-F07-DN DC24V**

For details, refer to page 25.



● Proportional control valve  
KFPV300

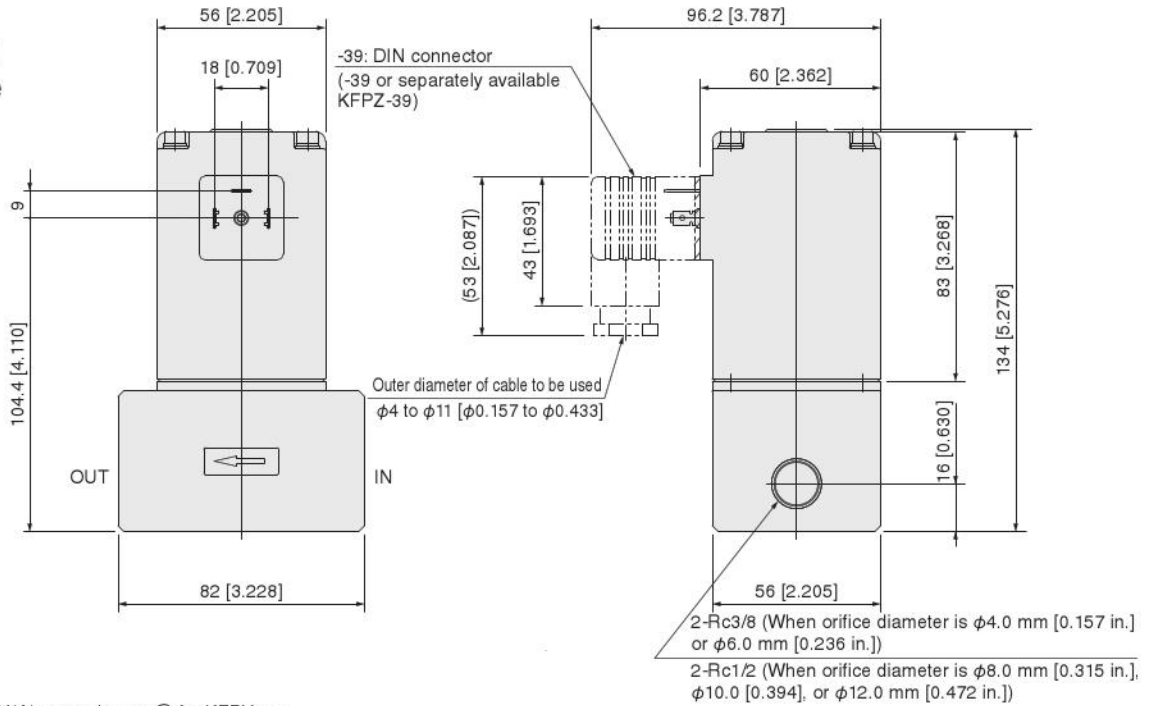

\* Refer to page ⑭ for KFPV(A)010 and page ⑳ for KFPV050.

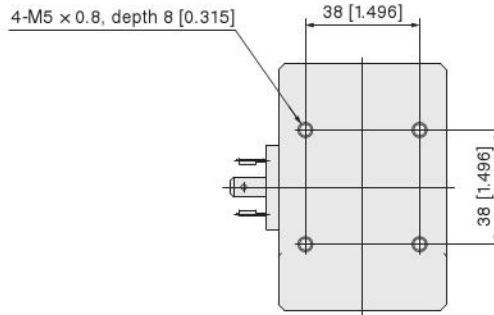

● Proportional control valve controller  
KFPC1-F07-DN

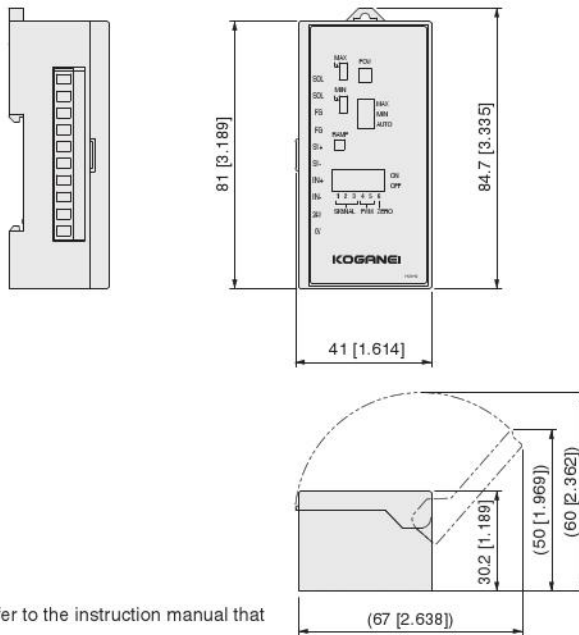

Note: For instructions about handling the controller, refer to the instruction manual that comes with the product.

\* This product was designed and manufactured for use in general industrial machinery. When this product is used in medical devices related to maintenance or management of human life or health, the system designer is required to perform adequate evaluation prior to use. The initial performance and safety of the system are up to the designer who has determined compatibility of the product with the system. Safe and reliable system configuration (e.g., failsafe) is required considering the possibility of equipment failure through adequate verification and evaluation based on the latest catalog and other technical documents.

KFPV010

KFPV050

KFPV300

KFPC1 Controller

ISO10993-compliant

# Limited Warranty

KOGANEI CORP. warrants its products to be free from defects in material and workmanship subject to the following provisions.

**Warranty Period** The warranty period is 180 days from the date of delivery.

**Koganei Responsibility** If a defect in material or workmanship is found during the warranty period, KOGANEI CORP. will replace any part proved defective under normal use free of charge and will provide the service necessary to replace such a part.

**Limitations**

- This warranty is in lieu of all other warranties, expressed or implied, and is limited to the original cost of the product and shall not include any transportation fee, the cost of installation or any liability for direct, indirect or consequential damage or delay resulting from the defects.

- KOGANEI CORP. shall in no way be liable or responsible for injuries or damage to persons or property arising out of the use or operation of the manufacturer's product.

- This warranty shall be void if the engineered safety devices are removed, made inoperative or not periodically checked for proper functioning.

- Any operation beyond the rated capacity, any improper use or application, or any improper installation of the product, or any substitution upon it with parts not furnished or approved by KOGANEI CORP., shall void this warranty.

- This warranty covers only such items supplied by KOGANEI CORP. The products of other manufacturers are covered only by such warranties made by those original manufacturers, even though such items may have been included as the components.

The specifications are subject to change without notice.

URL <http://www.koganei.co.jp>

E-mail: [overseas@koganei.co.jp](mailto:overseas@koganei.co.jp)



## KOGANEI CORPORATION

### OVERSEAS DEPARTMENT

3-11-28, Midori-cho, Koganei City, Tokyo 184-8533, Japan  
Tel: 81-42-383-7271 Fax: 81-42-383-7276

### KOGANEI INTERNATIONAL AMERICA, INC.

48860 Milmont Drive, suite 108C, Fremont, California 94538  
Tel: 1-510-744-1626 Fax: 1-510-744-1676

### SHANGHAI KOGANEI INTERNATIONAL TRADING CORPORATION

RM2601-2602, Tongda Venture Building No.1, Lane 600, Tianshan Road, Shanghai, China (200051)  
Tel: 86-21-6145-7313 Fax: 86-21-6145-7323

### TAIWAN KOGANEI TRADING CO., LTD

Rm. 2, 16F, No88, Sec. 2, Zhongxiao E. Rd., Zhongzheng Dist., Taipei City 100, Taiwan(ROC)  
Tel: 886-2-2393-2717 Fax: 886-2-2393-2719

### KOGANEI KOREA CO., LTD

A-3001, Heungdeok IT Valley Bldg., Heungkeok 1-ro, 13, Giheung-gu, Yongin-si, Gyeonggi-do, 446-908, KOREA  
Tel: 82-31-246-0414 Fax: 82-31-246-0415

### KOGANEI (THAILAND) CO., LTD

555 Rasa Tower 1, 12th Floor, Unit 1202 and 1207, Phaholyothin Road, Chatuchak, Bangkok 10900 Thailand  
Tel: 66-2-937-4250 Fax: 66-2-937-4254

### KOGANEI AUTOMATION (MALAYSIA) SDN. BHD.

Suite 29-2, Level 29, Menara 1MK, No.1, Jalan Kiara, Mont Kiara 50480, Kuala Lumpur, Malaysia  
Tel: 60-12-537-7086

### KOGANEI ASIA PTE. LTD.

69 Ubi Road 1, #05-18 Oxley Bizhub Singapore 408731  
Tel: 65-6293-4512 Fax: 65-6293-4513