

Complies with ISO and JIS standards

KSD Cylinder

$\phi 125$, $\phi 140$, $\phi 160$, $\phi 180$, $\phi 200$, $\phi 250$



KSD Cylinder



JIS standards cylinders with high power!

- Installation dimensions comply with JIS standards [JIS B 8368] (Excluding $\phi 140$ and $\phi 180$)

A wide selection of variations!

- Cylinder bores $\phi 125$ to $\phi 250$ (Up to $\phi 160$ for sensor cylinder)
- Strokes up to **2000mm** supported (Depends on model)
- Compatible with Class 2 pressure vessels

Connection port
 $\phi 125$: Rc1/2
 $\phi 140, \phi 160, \phi 180, \phi 200$: Rc3/4
 $\phi 250$: Rc1

SUS304 also available
(Piston rod and nut material)

*Photo shows **KBSDS160**×300.

Cylinder tube can be aluminum or steel.
*Sensor cylinders are available as aluminum tube type only.
($\phi 125, \phi 140, \phi 160$)

High-power dust wiper equipped as standard





4mm square sensor switches

- ZC130□ (2-lead wire solid state type with indicator)
- ZC153□ (3-lead wire solid state type with indicator)
- CS5T□ (2-lead wire reed switch type without indicator)
- CS11T□ (2-lead wire reed switch type with indicator)

Cushion needle

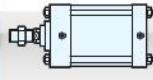
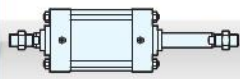
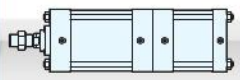
*Photo shows **KBSDS125**×300-**CS11TA2**.

Series lineup

	Basic Type	Foot Type	Rod Side Flange Type	Head Side Flange Type	Clevis Type (with supporting bracket)	Eye Type	Trunnion Type (with supporting bracket)	
Standard Cylinders	●	●	●	●	●	●	●	
<ul style="list-style-type: none"> Aluminum tube (φ 125 to φ 160) Steel tube (φ 125 to φ 250) 								
Double-rod Cylinders	●	●	●	●	●	●	●	
<ul style="list-style-type: none"> Aluminum tube (φ 125 to φ 160) Steel tube (φ 125 to φ 250) 								
Tandem Cylinders	●	●	●	●	●	●	●	
<ul style="list-style-type: none"> Aluminum tube (φ 125 to φ 160) Steel tube (φ 125 to φ 250) 								
Dual Stroke Cylinders	●	●	●	●	●	●	●	
<ul style="list-style-type: none"> Aluminum tube (φ 125 to φ 160) Steel tube (φ 125 to φ 250) 								
Push Side Stroke Adjustment Cylinders	●	●	●	●	●	●	●	
<ul style="list-style-type: none"> Aluminum tube (φ 125 to φ 160) Steel tube (φ 125 to φ 250) 								
Pull Side Stroke Adjustment Cylinders	●	●	●	●	●	●	●	
<ul style="list-style-type: none"> Aluminum tube (φ 125 to φ 160) Steel tube (φ 125 to φ 160) 								
Low Hydraulic Cylinders	●	●	●	●	●	●	●	
<ul style="list-style-type: none"> Aluminum tube (φ 125 to φ 160) Steel tube (φ 180 to φ 250) 								

Mounting types

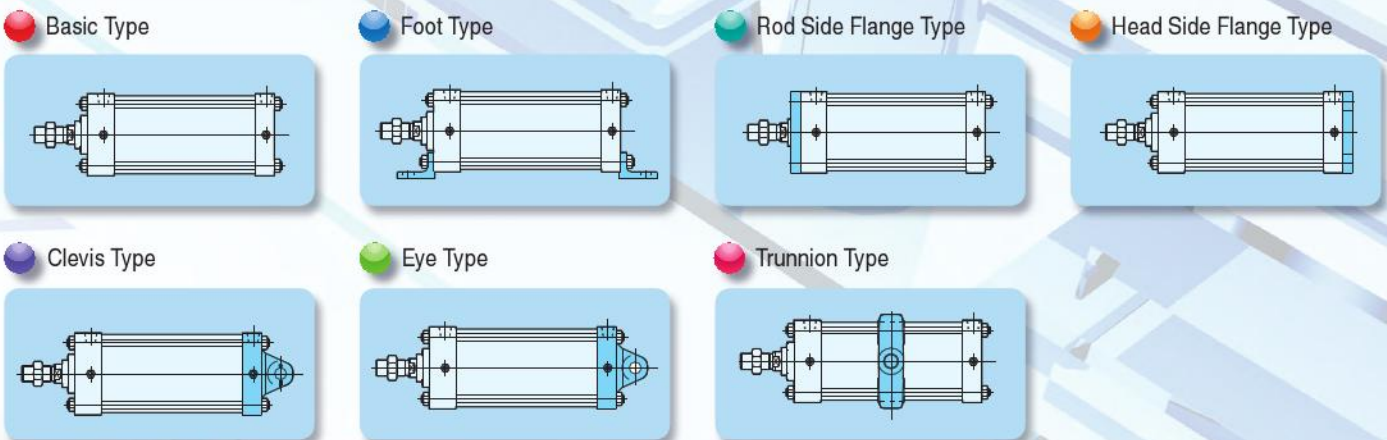





INDEX

Features	1	Double-rod Cylinders	19	Low Hydraulic Cylinders	35
Safety Precautions	3	Tandem Cylinders	23	Y-knuckles, I-knuckles	33
Handling Instructions and Precautions	5	Dual Stroke Cylinders	27	Bellows, Options	39
Standard Cylinders	11	Stroke Adjustment Cylinders	31	Sensor Switches	41

Before selecting and using the products, please read all the "Safety Precautions" carefully to ensure proper product use. The Safety Precautions described below are to help you use the product safely and correctly, and to prevent injury or damage to you, other people, and assets. Be sure to observe these safety precautions together with the following safety regulations of ISO4414 (Pneumatic fluid power - General rules and safety requirements for systems and their components), and JIS B 8370 (General rules relating to systems).

The directions are ranked according to degree of potential danger or damage: "DANGER", "WARNING", "CAUTION" and "ATTENTION."

 DANGER	Indicates situations that can be clearly predicted as dangerous. Death or serious injury may result if the situation is not avoided. It could also result in damage or destruction of assets.
 WARNING	Indicates situations that, while not immediately dangerous, could become dangerous. Death or serious injury may result if the situation is not avoided. It could also result in damage or destruction of assets.
 CAUTION	Indicates situations that, while not immediately dangerous, could become dangerous. Failure to avoid the situation creates the risk of minor or semi-serious injury. It could also result in damage or destruction of assets.
 ATTENTION	While there is little chance of injury, this content refers to points that should be observed for appropriate use of the product.

- This product was designed and manufactured for use in general industrial machinery.
- When selecting and handling equipment, the system designer or another person with sufficient knowledge and experience should always read the "Safety Precautions", "catalog", "instruction manual", and other literature before commencing operation. Improper handling is dangerous.
- After reading the instruction manual, catalog, and other documentation, always place them in a location that allows easy availability for reference to users of this product.
- Whenever transferring or lending the product to another person, always attach the catalog, instruction manual, and other information to the product where they are easily visible in order to ensure that the new user can use the product safely and properly.
- The danger, warning and caution items listed under these "Safety Precautions" do not cover all possible contingencies. Read the catalog and instruction manual carefully, and always keep safety first.

DANGER

- Do not use the product for the purposes listed below:
 1. Medical equipment related to maintenance or management of human lives or bodies.
 2. Machines or equipment designed for the purpose of moving or transporting people.
 3. Critical safety components in mechanical devices.

This product has not been planned or designed for purposes that require high levels of safety. Using the product in any of the ways described above creates the risk of loss of human life.
- Do not use the product in locations with or near dangerous substances such as flammable or ignitable substances. This product is not explosion-proof. Doing so creates the risk of ignition or fire.
- When mounting the product and workpiece, always make sure they are firmly supported and secured in place. Falling, dropping, or abnormal operation of the product creates the risk of personal injury.
- Persons using a pacemaker or other similar medical devices should maintain a distance of at least 1 meter away from the product. Getting too close to the product creates the risk of malfunction of a pacemaker due to the strong magnet built into the product.
- Never attempt to modify the product in any way. Doing so creates the risk of injury, electric shock, fire, etc. due to abnormal operations.
- Never attempt inappropriate disassembly, assembly, or repair of the product relating to basic construction, or to its performance or functions. Doing so creates the risk of injury, electric shock, fire, etc.
- Do not allow water to splash on the product. Water spraying on the product, washing the product, or using the product under water creates the risk of malfunction, leading to injury, electric shock, fire, etc.
- While the product is in operation, avoid touching it with your hands or otherwise approaching too close. Also, do not attempt to make any adjustments to internal or attached mechanism, or to perform any type of adjustment (stroke adjustment mechanism, sensor switch mounting location, piping tube or plug disconnection, etc.) while the product is in operation. This may cause a sudden cylinder movement or any other items that creates the risk of personal injury.
- When operating the product, always install speed controllers, and gradually loosen the needle valve from a choked state to adjust the increase in speed. Failure to make this adjustment, sudden movements can take place by the air supply, which may cause the loss of human life.
- Do not apply the load exceeding the buckling/bending strength to the piston rod. This can cause to shorten the product operating life and to create abnormal wear or breakage of rods and tubes.
- Make sure to align the piston rod axis and the load moving direction. Failure to do so, straining force will be applied to the piston rod or the tube, causing abnormal wear or breakage.

WARNING

- Do not use the product in excess of its specification ranges. Doing so creates the risk of product breakdown, loss of function, or damage. It could also drastically reduce the product's operating life.
- Before supplying air or electricity to the device and before starting operation, always conduct a safety check of the area where the machine is operating. Unintentional supply of air or electricity creates the risk of electric shock or injury due to contact with moving parts.
- Do not touch terminals or switches while power is turned on. Doing so creates the risk of electric shock and abnormal operation.
- Do not allow the product to be thrown into fire. Doing so creates the risk of explosion, resulting in the release of toxic gasses.
- Do not sit on the product, place your foot on it, or place other objects on it. Doing so creates the risk of injury due to tripping or the product tipping over or dropping, resulting in product damage and abnormal, erratic or runaway operation.
- Before conducting maintenance, inspection, repair, replacement, or any other similar procedure, always completely cut off all air supply and confirm that residual pressure inside the product or in piping connected to the product is zero. In particular, be aware that residual air will still be in the compressor or storage tank. The cylinder may move abruptly if residual air pressure remains inside the piping, causing injury.
- Do not use the cylinder as a device aiming to absorb the shock or vibration of machinery. Doing so may create the risk of injury or the breakdown of the machinery.
- Do not allow lead wires of sensor switches and other cords to become damaged. Allowing a cord to become damaged, bent excessively, pulled, rolled up, placed under heavy object, or squeezed between two objects creates the risk of current leaks or defective continuity that can lead to fire, electric shock, or abnormal operation.
- Do not allow the cylinder rod bush to be subjected to a side load of 1/20 or greater of the cylinder thrust. Such a load reduces operating life, and can lead to galling of and damage to the rod or tube.
- While cylinder is in motion, do not apply external magnetic field to sensor switches. Doing so creates the risk of unintentional movement of the product, resulting in breakdown of equipment or personal injury.
- Use the product within the range of recommended load and specified speed. Using outside the range creates the risk of damaging the cylinder, resulting the breakdown of the equipment or personal injury.

- Use safety circuits or design a system that prevents damage to machinery and personal injury when the machine is shut down due to an emergency stop or electrical power failure.
- When the pressure is increased by external force, make sure to attach the relief device or any other means not to exceed the specified operating pressure of the cylinder. Pressure exceeding the specified operating pressure may lead to malfunction and breakdown.
- When the machine has been idle for over 48 hours or is in first operation after storage, it is possible that the contacting parts may have become stuck, leading to operation delays or sudden movements. In initial operation, be sure to perform trial operation to check whether the machine works properly.
- Never use the product in direct sunshine-suffered location like beach, near mercury lamp, or near a product likely to produce ozone. Deterioration of rubber parts caused by ozone may reduce the performance and function or stop the function.
- Because KOGANEI products may be used under a wide variety of conditions, decisions concerning conformance with a particular system should be made upon the careful evaluation by the person in charge of system design. Assurances concerning expected system performance and safety are the responsibility of the designer who decides system conformity. Be sure to use the latest catalogs and technical materials to study and evaluate specification details, to consider the possibility of machine breakdown, and to configure a system that ensures fail-safe safety and reliability.
- Do not use in locations that are subject to direct sunlight (ultraviolet rays), in locations with dust, salt, or iron particles, or in locations with media and/or ambient atmosphere that include organic solvents, phosphate ester type hydraulic oil, sulfur dioxide, chlorine gas, acids, etc. Such uses could lead to early shutdown of some functions, a sudden degradation of performance, and a reduced operating life. For details on materials used in the product, refer to the description of materials used in major parts.

CAUTION

- When mounting the product, leave room for adequate working space around it. Failure to do so will make it more difficult to conduct daily inspections or maintenance, which could eventually lead to system shutdown or damage to the product.
- When transporting or mounting a heavy product, firmly support the product using a lift or support, or use multiple people to ensure personal safety.
- Do not bring any magnetic media or memory within 1 meter of the product. Doing so creates the risk of damage to data on the magnetic media due to magnetism.
- The sensor switch should not be used in a location where high current or magnetic field is generated. This may cause the machine to malfunction or erratic operation. Also avoid using magnetic material for any parts used for mounting. Doing so creates the risk of magnetism leakage that causes malfunctions or erratic operation.
- Do not bring the product close to magnetized body. Positioning it near a magnetic body or strong magnetic field will cause erratic operation of sensor switches due to magnetization of the main body, rod, or other components, or cause failure due to adherence of iron powder, etc.
- Make absolute sure that sensor switches of other companies are not used for this product. Failure to do so can lead to malfunctions or runaway operations.
- Do not scratch, dent, or deform the actuator by climbing on the product, using it as a scaffold, or placing objects on top of it. Doing so creates the risk of damage to or breakage of the product, resulting in operational shutdown or degraded performance.
- Always post an "operations in progress" sign for installations, adjustments, or other operations, to avoid unintentional supplying of air or electrical power, etc. Unintended power or air supply can cause electric shock or sudden cylinder movement, creating the risk of personal injury.
- Do not apply excessive load to the cords, such as the lead wires of sensor switches mounted on the cylinder, in such manner as pulling, carrying by hands or placing heavy object on the cords. Doing so may cause the leak current or defective continuity, leading to fire, electric shock or malfunctions.

- Using in extremely dry air which dew point exceeds 20 degrees below zero Celsius may affect the quality of the lubricating oil used. This creates the risk of degraded performance, loss of function, or other problems.
- This product uses internal lubrication, and so oil may flow out from the rod or from pipe ports.

ATTENTION

- Whenever considering use of this product in situations or environments not specifically noted in the "catalog" or "instruction manual", or in applications where safety is an important requirement such as in aircraft facilities, combustion equipment, leisure equipment, safety equipment, and other places where human life or assets may be greatly affected, take adequate safety precautions such as allowing plenty of margin for ratings and performance, or fail-safe measures. Be sure to contact KOGANEI before use in such applications.
- Always check the "catalog" and other reference materials for product wiring and piping.
- Moving parts of machine and devices should be isolated with a protection cover so as not to be directly contacted by human body.
- Do not configure the control system that may cause a workpiece to drop when in power outage. Be sure to configure the work/table-drop prevention control for the case of power outage or emergency stop of the machine.
- When handling the product, wear protective gloves, safety glasses, safety shoes, etc., as required.
- When the product can no longer be used or is no longer necessary, dispose of it appropriately as industrial waste.
- Pneumatic equipment can exhibit degraded performance and function over its operating life. Always conduct daily inspections of the pneumatic equipment, and confirm that all requisite system functions are satisfied, to prevent accidents from happening.
- For inquiries about the product, consult your nearest KOGANEI sales office or KOGANEI overseas department. The addresses and telephone numbers are shown on the back cover of this catalog.

Others

- Always observe the following items. KOGANEI shall not be held responsible for any problems that occur as a result of these items not being properly observed.
 1. When using this product in pneumatic systems, always use genuine KOGANEI parts or compatible products (recommended parts). When conducting maintenance and repairs, always use genuine KOGANEI parts or compatible products (recommended parts). Always observe the prescribed methods and procedures.
 2. Never attempt inappropriate disassembly or assembly of the product relating to basic construction, or its performance or functions.

KOGANEI shall not be held responsible for any problems that occur as a result of these safety precautions not being properly observed.



Design and Selection

WARNING

1. Check the specifications.

Using outside of specification range in voltage, current, temperature, shock, etc. creates the risk of breakdown or malfunctions of the product. Read the specifications carefully before using.

2. Avoid mounting cylinders in close proximity to each other

Mounting two or more cylinders with sensor switches in close proximity may result in erratic operation of the sensor switches due to magnetic field interference.

3. Where the position detection is made at mid-stroke, be cautious against the sensor switch ON time.

Be aware that, when the sensor switch is mounted at intermediate point of cylinder stroke to detect passing of the piston, too fast speed of the piston can shorten the sensor switch operation time, causing the load, such as programmable controllers, to fail to operate.

The highest detectable cylinder speed is

$$V \text{ [mm/s]} = \frac{\text{Sensor switch operating range [mm]} \times 1000}{\text{Time required for load operation [ms]}}$$

4. Keep wiring as short as possible.

The wiring for solid state sensor switches must be 30 m or shorter, as stipulated by EN standard. For reed sensor switches, the longer wiring (10 m or longer) will lead to the larger capacitive surge current, which reduces the operating life of sensor switches. When a longer wiring cannot be avoided, provide the protective circuit described in the catalog.

If the load is inductive or capacitive, provide the appropriate protective circuit as described in the catalog.

5. Avoid repeated bending or excessive pulling of lead wires.

Applying repeated bending or pulling force on the lead wires could cause breaking the wire.

6. Check for leakage current.

2-lead wire solid state sensor switches produce the current (leakage current) even at off condition to activate the internal circuit. Ensure that they satisfy the following inequality:

Input off current of programmable controller > Leakage current
If the above inequality is not satisfied, select 3-lead wire solid state sensor switch. And, if n-pieces sensor switches are connected in parallel, the leakage current increases by n times.

CAUTION

1. Check for internal voltage drop of sensor switches.

When reed sensor switches with indicator lamps or 2-lead wire solid state sensor switches are connected in series causes increasing internal voltage drop, and the load may fail to activate. Connecting n-pieces will drop the internal voltage by n times as large.

Ensure the circuit satisfy the following inequality.

$$\text{Power supply voltage} - \text{Internal voltage drop} \times n > \text{Minimum operating voltage of the load}$$

In relays with rated voltage of less than 24VDC, check to see the above inequality is satisfied even when n=1.

When the above inequality is not satisfied, select a reed sensor switch without indicator lamp.

2. Do not use Koganei sensor switches with other company's cylinders.

The sensor switches are designed for use with our Koganei cylinders only. Using with other company's cylinders may not function properly.



Installation and adjustment

WARNING

1. Do not apply an external magnetic field to the sensor switch while the cylinder is in operation.

This may cause unintended operation, thereby damaging the device and causing personal injury.

CAUTION

1. Ensure a safe installation environment for the cylinders with sensors.

The sensor switch should not be used in a location where large current or high magnetic field is present. It could result in erratic operation.

Do not use magnetic material for the mounting portion. This may cause erratic operation.

2. Install the sensor switches in the center of their operating range.

Adjust the mounting position of the sensor switch so that the piston can stop in the center of the operating range (the sensor turned-on range). Setting the switch ON the end of the operating range (at the boundary of ON/OFF) may cause the operation to be unstable. Also be aware that the operating range will vary according to the temperature change.

3. Follow the tightening torque for the sensor switches when mounting.

Tightening the screw exceeding the allowable tightening torque may damage the mounting thread, mounting bracket, sensor switch etc. In addition, insufficient tightening torque could cause the sensor switch position to be changed, thereby resulting in unstable operation. For details about tightening torque, refer to Page 42.

4. Do not carry the cylinder by its mounted sensor switch's lead wire.

After mounting a sensor switch on the cylinder, do not carry the cylinder by grabbing the lead wire. This may not only damage the lead wire but also apply stress to the inside of the sensor switch that may damage internal elements, so never perform such behavior.

5. Do not drop the sensor switches or bump them against other objects.

When handling the product, take care to avoid dropping it, allowing it to bump against other objects, or otherwise subjecting it to excessive impact (294.2 m/s² or more).

In the case of reed sensor switches, such behavior may cause the contact to malfunction, thereby giving a signal or turning off the signal instantaneously. And, this may change the contact interval, thereby deteriorating the sensor switch's sensitivity. As such, this may cause the device to malfunction. Even if the sensor switch case is not damaged, the inside of the sensor switch may be damaged, causing erratic operation.

Safety Precautions (Sensor switch)



Wiring

DANGER

1. Prevent nearby moving objects from coming into contact with sensor switches.

When the cylinders equipped with sensor switches are moving, or when moving objects are nearby, do not let them come into contact each other. In particular, lead wires may become worn or damaged causing unstable operation of the sensor switch. In the worst case, this may result in current leakage or electric shock.

2. Always turn off the power before performing wiring work.

Wiring work while the power is on could result in electric shock. Also, incorrect wiring could damage the sensor switch in an instant. Turn on the power after completing the wiring work.

WARNING

1. Check the "catalog" and other reference materials for correct wiring.

Improper wiring could result in abnormal operation.

2. Do not share wiring with power or high voltage lines.

Avoid wiring in parallel to or shared in the same conduit with power line and high-voltage line. Such wiring could cause the sensor switch and control circuit to suffer erratic operation by electric noise.

3. Be cautious against not bending the lead wire repeatedly or applying tension force to the wire.

Applying repeated bending stress or tension force to the lead wire may cause the wire to be broken.

4. Check polarity in the wiring.

For the sensor switch with the polarities (+, -, output) indicated, make sure that wiring connections are correct. The wrong polarities will result in damage to sensor switches.

CAUTION

1. Avoid short circuiting loads.

Turning on the sensor switch while the load is short-circuited causes overcurrent, which will damage the sensor switch in an instant.

Example of short-circuit load: Sensor switch's output lead wire is directly connected to the power supply.

Warranty and General Disclaimer

1. Warranty Period

The warranty period for KOGANEI products is 180 days from the date of delivery.

2. Scope of Warranty and General Disclaimer

- (1) The KOGANEI product warranty covers individual products. When a product purchased from KOGANEI or from an authorized KOGANEI distributor malfunctions during the warranty period in a way that is attributable to KOGANEI responsibility, KOGANEI will repair or replace the product free of charge. Even if a product is still within the warranty period, its durability is determined by its operation cycles and other factors. Contact your nearest KOGANEI sales office or the KOGANEI overseas department for details.
- (2) KOGANEI shall not be held responsible for any losses or for any damage to other machinery caused by breakdown, loss of function, or loss of performance of KOGANEI products.
- (3) KOGANEI shall not be held responsible for any losses due to use or storage of the product in a way that is outside of the product specifications prescribed in KOGANEI catalogs and the instruction manual, and/or due to actions that violate the mounting, installation, adjustment, maintenance and other safety precautions.
- (4) KOGANEI shall not be held responsible for any losses caused by breakdown of the product due to factors outside the responsibility of KOGANEI, including but not limited to fire, natural disaster, the actions of third parties, and intentional actions or errors by you.

Handling Instructions and Precautions



General precautions

Air supply

1. Use air as the medium. For the use of any other medium, consult Koganei.
2. Use clean compressed air that contains no moisture, dust, oxidized oil or other impurities to operate the KSD cylinder. Install an air filter (filtration of 40 μ m or less) near the KSD cylinder or valve to remove dust or accumulated liquid. Also, periodically drain the air filter.

Piping

1. Before performing piping work on the KSD cylinder, be sure to thoroughly flush the inside of the pipes with compressed air. Machining chips, sealing tape, rust and other debris remaining from the piping work may result in air leaks and malfunctions.
2. When screwing pipes or fittings into the KSD cylinder, use the appropriate tightening torque shown below:

Connecting thread	Tightening Torque N·m
Rc1/2	27 to 29
Rc3/4	27 to 29
Rc1	35 to 37

Atmosphere

Cover the unit when using it in locations where it might be subject to excessive dust, dripping water, dripping oil, etc.

Lubrication

This cylinder is a non-lubrication type, so lubrication is not required. If lubrication will be applied, use Class 1 turbine oil (ISO VG32) or No. 2 lithium soap-based grease or its equivalent. Minimize the use of lubrication as much as possible. Avoid use of spindle oil and machine oil.

Disassembly and replacement

To disassemble the cylinder, loosen the tie rod nuts and remove the cover.

When reassembling, evenly tighten the tie rod nuts in a diagonal pattern. When tightening, also check the tie rod projection dimension. Tightening torque values are shown below.

When replacing seals, apply grease (No. 2 lithium soap-based grease or its equivalent). Operation of the cylinder without grease applied causes very high seal wear and early failure.

Following reassembly, check for proper operation. Incorrect reassembly can result in faulty operation and early failure.



Disassembling and reassembling a product voids its warranty.

Tie rod nut width across flats and tightening torque

Cylinder bore mm	Width across flats mm	Tightening Torque N·m
125	19	22
140 · 160 · 180 · 200	24	55
250	30	110

Class 2 Pressure Vessel Precautions

1. A Class 2 pressure vessel cannot be transferred, loaned, or installed unless it complies with the Construction Code for Pressure Vessels issued by Japan's Ministry of Health, Labor, and Welfare.
2. Installation of a Class 2 pressure vessel requires certification inspection by the director of the Prefectural Labor Bureau or by the Individual Examination Agency for Statutory Inspections based on Japan's Boiler and Pressure Vessel Safety Regulations. When the certification inspection is passed, a Class 2 Pressure Vessel Detailed Specification Sheet marked with a stamp attesting to the fact that the individual certification inspection was passed is issued. The detailed specification sheet is appended to the product when it is shipped.
3. A Class 2 pressure vessel detailed specification sheet is an important document certifying that this pressure vessel complies with the requirements of the above mentioned construction code. Store the Class 2 pressure vessel detailed specification sheet in a safe place where it will not become torn, soiled or lost.
4. A Class 2 pressure vessel detailed specification sheet can be re-issued only within one year after the individual certification inspection is conducted. In all other cases, re-issuance requires a new individual certification inspection. You can request a Certification inspection to the Japan Boiler Association.
5. Be sure to observe the points described below when installing a Class 2 pressure vessel.
 - a. Adjust safety valves to operate at a level at or below the maximum operating pressure.
 - b. Mark the pressure gauge scale with an easily noticeable red mark at the maximum operating pressure point.
 - c. Conduct periodic voluntary inspections at least once a year on the items listed below and maintain records of inspection results for three years.
 - ① Cylinder body damage presence or absence
 - ② Cover bolt wear presence or absence
 - ③ Piping and valve damage presence or absence

Air flow rate and air consumption

Air cylinder air flow rate and air consumption are calculated using the equation below. However, values can be determined more easily using the table to the right.

Air flow rate

$$Q_1 = \frac{\pi D^2}{4} \times L \times \frac{60}{t} \times \frac{P+0.101}{0.101} \times 10^{-6}$$

Air consumption

$$Q_2 = \frac{\pi D^2}{4} \times L \times 2 \times n \times \frac{P+0.101}{0.101} \times 10^{-6}$$

Q₁: Air flow rate required by the cylinder

Q₂: Cylinder air consumption

D : Cylinder bore

L : Cylinder stroke

t : Time needed for the cylinder to travel 1 stroke

n : Cylinder reciprocations

P : Air pressure

ℓ / min (ANR)

ℓ / min (ANR)

mm

mm

s

per/min

MPa

Air consumption for every 1 mm of the stroke

cm³/reciprocations (ANR)

Cylinder bore mm	Air pressure (MPa)									
	0.1	0.2	0.3	0.4	0.5	0.6	0.7	0.8	0.9	1
125	48.8	73.1	97.4	121.7	146.0	170.3	194.6	218.9	243.2	267.6
140	61.3	91.8	122.2	152.7	183.2	213.7	244.2	274.6	305.1	335.6
160	80.0	119.8	159.7	199.5	239.3	279.1	318.9	358.7	398.5	438.4
180	101.3	151.7	202.1	252.5	302.8	353.2	403.6	454.0	504.4	554.8
200	125.0	187.3	249.5	311.7	373.9	436.1	498.3	560.5	622.7	684.9
250	195.4	292.6	389.8	487.0	584.2	681.4	778.6	875.8	973.0	1070.2

The values in the table are calculated based upon the air flow rate and air consumption at a 1 mm stroke cylinder during 1 reciprocation of the air cylinder. Actually required air flow rate and air consumption are calculated with the equations below.

- When calculating air flow (When selecting F.R.L., valves, etc.)

Example 1: For an air cylinder with a bore of 125 mm traveling at a speed of 200 mm/s, operating with air pressure of 0.5 MPa.

$$146.0 \times \frac{1}{2} \times 200 \times 10^{-3} = 14.6 \text{ ℓ/s (ANR)}$$

(The flow rate per minute is calculated using the equation $146.0 \times \frac{1}{2} \times 200 \times 60 \times 10^{-3} = 876 \text{ ℓ/min (ANR)}$.)

- When calculating air consumption

Example 1: For one reciprocation of an air cylinder with a bore of 125 mm and stroke of 100 mm, at an air pressure of 0.5 MPa.

$$146.0 \times 100 \times 10^{-3} = 14.6 \text{ ℓ/reciprocations (ANR)}$$

Example 2: For 10 reciprocations of an air cylinder with a bore of 125 mm and stroke of 100 mm, at an air pressure of 0.5 MPa.

$$146.0 \times 100 \times 10 \times 10^{-3} = 146 \text{ ℓ/min (ANR)}$$

Thrust

Calculate the required thrust from the load and the operating air pressure in order to determine the appropriate cylinder bore.

Note that the values in the table below are theoretical thrust values. Select the cylinder bore that results in a load ratio (Load Ratio = $\frac{\text{Load}}{\text{Theoretical Thrust}}$) of no more than 70% (no more than 50% in the case of high speed).

Cylinder bore mm	Rod diameter mm	Operation	Pressure area mm ²	Air pressure (MPa)									
				0.1	0.2	0.3	0.4	0.5	0.6	0.7	0.8	0.9	1
125	32	Push side	12272	1227	2454	3682	4909	6136	7363	8590	9817	11045	12272
		Pull side	11468	1147	2294	3440	4587	5734	6881	8027	9174	10321	11468
140	40	Push side	15394	1539	3079	4618	6158	7697	9236	10776	12315	13854	15394
		Pull side	14137	1414	2827	4241	5655	7069	8482	9896	11310	12723	14137
160	40	Push side	20106	2011	4021	6032	8042	10053	12064	14074	16085	18096	20106
		Pull side	18850	1885	3770	5655	7540	9425	11310	13195	15080	16965	18850
180	40	Push side	25447	2545	5089	7634	10179	12723	15268	17813	20358	22902	25447
		Pull side	24190	2419	4838	7257	9676	12095	14514	16933	19352	21771	24190
200	40	Push side	31416	3142	6283	9425	12566	15708	18850	21991	25133	28274	31416
		Pull side	30159	3016	6032	9048	12064	15080	18096	21112	24127	27143	30159
250	45	Push side	49087	4909	9817	14726	19635	24544	29452	34361	39270	44179	49087
		Pull side	47497	4750	9499	14249	18999	23748	28498	33248	37998	42747	47497

N

Inner Construction and major parts

Standard Cylinder KBSD Aluminum Tube Type

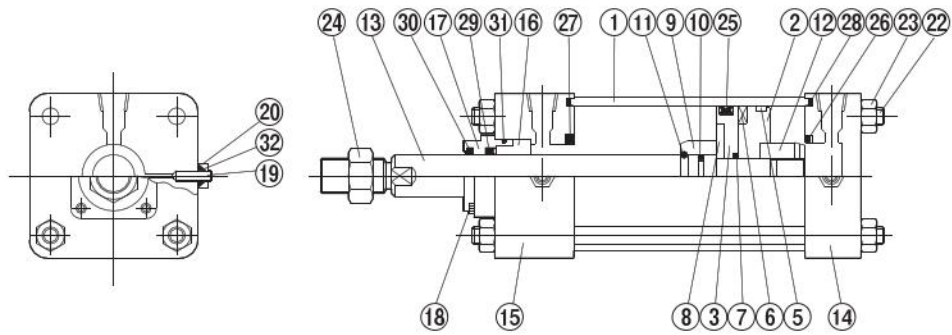

Standard Cylinder KCSD Steel Tube Type

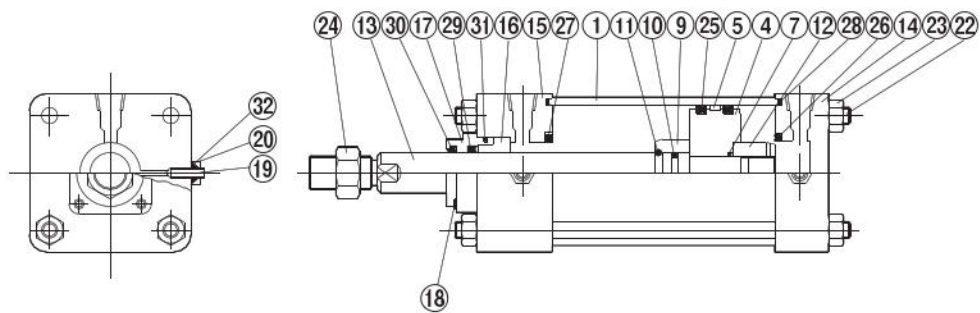

Low Hydraulic Cylinder KBSDH/KCSDH Aluminum Tube Type/Steel Tube Type

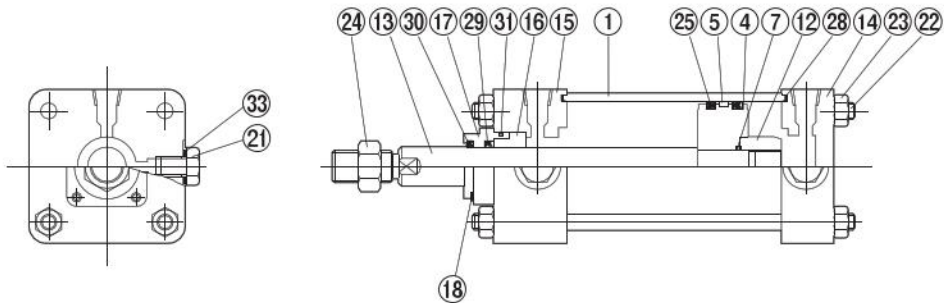

Materials used in major parts

No.	Name	Materials	Quantity
①	Cylinder tube	KBSD, KBSDH Aluminum alloy KCSD, KCSDH Carbon steel for machine structures	1
②	Piston A (KBSD type)	Aluminum alloy	1
③	Piston B (KBSD type)	Aluminum alloy	1
④	Piston (KBSDH, KCSD, KCSDH)	Carbon steel for machine structures	1
⑤	Wear ring	Plastic	2
⑥	Magnet	Plastic magnet	1
⑦	Piston rod O-ring	Nitrile rubber	1
⑧	Piston washer	Rolled steel for general structures	1
⑨	Cushion ring	Rolled steel for general structures	1
⑩	O-ring for cushion ring	Synthetic rubber (NBR)	1
⑪	Stop ring	Piano wire	1

No.	Name	Materials	Quantity
⑫	Piston nut	Rolled steel for general structures	1
⑬	Piston rod	Carbon steel for machine structures	1
⑭	Head cover	Rolled steel for general structures	1
⑮	Rod cover	Rolled steel for general structures	1
⑯	Bushing	Oil impregnated sintered metal	1
⑰	Seal housing	Carbon steel for machine structures	1
⑱	Seal housing fixing screw	Chromium molybdenum steel	4
⑲	Cushion valve	Chromium molybdenum steel	2
⑳	Cushion lock nut	Rolled steel for general structures	2
㉑	Air bleeder (KBSDH, KCSDH)	Rolled steel for general structures	2
㉒	Tie rod	Carbon steel for machine structures	4
㉓	Tie rod nut	Rolled steel for general structures	8
㉔	Rod end lock nut	Rolled steel for general structures	1

⑰ is when bellows are included.

When -RS is selected, the material for 13 and 24 is stainless steel.

Materials used in major parts (Seals)

Standard Cylinder KBSD

Aluminum Tube Type

No.	Name	Materials	Quantity
25	Piston seal	Synthetic rubber (NBR)	1
26	Cushion seal (H side)	Synthetic rubber (NBR)	1
27	Cushion seal (R side)	Synthetic rubber (NBR)	1
28	Tube end seal	Synthetic rubber (NBR)	2
29	Rod seal	Synthetic rubber (NBR)	1
30	Dust wiper	Urethane rubber	1
31	O-ring for seal housing	Synthetic rubber (NBR)	1
32	Cushion valve seal	Fluororesin	2

Standard Cylinder KCSD

Steel Tube Type

No.	Name	Materials	Quantity
25	Piston seal	Synthetic rubber (NBR)	2
26	Cushion seal (H side)	Synthetic rubber (NBR)	1
27	Cushion seal (R side)	Synthetic rubber (NBR)	1
28	Tube end seal	Synthetic rubber (NBR)	2
29	Rod seal	Synthetic rubber (NBR)	1
30	Dust wiper	Urethane rubber	1
31	O-ring for seal housing	Synthetic rubber (NBR)	1
32	Cushion valve seal	Fluororesin	2

* When seal material is fluoro-rubber

No.	Name	Materials	Quantity
25	Piston seal	Fluoro-rubber	2
26	Cushion seal (H side)	Synthetic rubber (NBR)	1
27	Cushion seal (R side)	Synthetic rubber (NBR)	1
28	Tube end seal	Fluoro-rubber	2
29	Rod seal	Fluoro-rubber	1
30	Dust wiper	Fluoro-rubber	1
31	O-ring for seal housing	Fluoro-rubber	1
32	Cushion valve seal	Fluororesin	2

Low Hydraulic Cylinder KBSDH/KCSDH

Aluminum Tube Type/Steel Tube Type

No.	Name	Materials	Quantity
25	Piston seal	Synthetic rubber (NBR)	2
28	Tube end seal	Synthetic rubber (NBR)	2
29	Rod seal	Synthetic rubber (NBR)	1
30	Dust wiper	Urethane rubber	1
31	O-ring for seal housing	Synthetic rubber (NBR)	1
33	Screw seal	Synthetic rubber (NBR)	2

KSD Tandem Cylinders

KCSDT (Steel Tube Type)
 $\phi 125, \phi 140, \phi 160, \phi 180, \phi 200, \phi 250$

Symbol

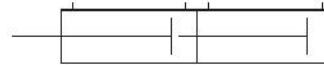

Specifications

Item	Cylinder bore mm	125	140	160	180	200	250
Operating type		Double acting type					
Medium		Air					
Mounting type		Basic type, foot type, rod side flange type, head side flange type, clevis type, eye type, trunnion type					
Operating pressure range	MPa	0.1 to 0.7					
Proof pressure	MPa	1.05					
Operating temperature range	°C	0 to 60 (no freezing, fluoro rubber seal material specifications: 0 to 100)					
Operating speed range	mm/s	50 to 700					
Cushion		Variable cushion at both stroke ends					
Cushion stroke	mm	17 (rod side), 15 (head side)	20 (rod side, head side)				22 (rod side, head side)
Lubrication		Not required (If lubrication will be applied, use Class 1 turbine oil [ISO VG32] or its equivalent.)					
Connection port size	Rc	1/2	3/4			1	

Cylinder bore and stroke

Cylinder bore	Available stroke (Stroke 1 x 2 + Stroke 2)
125	
140	
160	1 to 2000 (1 to 1400)
180	* The minimum stroke for the trunnion type is when Stroke 1 + Stroke 2 is at least 10 mm.
200	
250	

Note 1: Values in parentheses are when bellows are equipped.

2: Stroke tolerance is $+1.0$ for a stroke of 250 or shorter, $+1.5$ for a stroke of 251 to 1000, and $+2.0$ for a stroke of 1001 to 2000.

Cylinders with a stroke value that is longer than or equal to the following should be treated as Class 2 Pressure Vessels.

Cylinder bore	Cylinder stroke
160	1894
180	1474
200	902
250	693

● Stroke 1 and Stroke 2

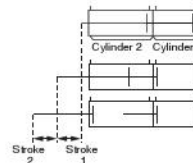

Stroke 1 is the Cylinder 1 stroke.
 Stroke 2 is the Cylinder 2 stroke minus the Cylinder 1 stroke.

Order Codes

KCSD T 125×100×100 - - - - -

Cylinder bore
 ×
Stroke 1^{Note 3}
 ×
Stroke 2^{Note 3}

Piston rod and nut material^{Note 4}
Blank — Standard
RS — SUS304

Mounting types
Blank — Basic Type
1 — Foot Type
3 — Rod-side Flange Type
5 — Head-side Flange Type
7 — Clevis Type (with pin)
7C — Clevis Type (with supporting bracket)
8 — Eye Type
11 — Trunnion Type^{Note 5}
11T — Trunnion Type (with supporting bracket)^{Note 5}
 ● Cylinder is shipped with mounting bracket installed.

Rod end accessory
Blank — No rod end accessory
Y — With Y-knuckle (With double knuckle rod joint and pin)
I — With I-knuckle (With single knuckle rod joint)
 ● Rod end accessories can be ordered alone.
 ● For details about rod end accessory dimensions, see page 33.

Bellows type (when bellows are equipped)
JT — Nylon tarpaulin (0 to 80°C)
JC — Chloroprene (0 to 100°C)
JK — Conex (0 to 100°C)
 ● Conex is a registered trademark of Teijin Limited.

Cylinder specifications^{Note 2}
Blank — Standard specifications (0 to 60°C)
J — Standard specifications with bellows (0 to 60°C)
F — Fluoro rubber seal material specifications (0 to 100°C)
FJ — Fluoro rubber seal material specifications with bellows (0 to 100°C)

Tandem Cylinders

Basic type (Steel tube type)^{Note 1}

Note 1: KCSD cylinders are $\phi 125, \phi 140, \phi 160, \phi 180, \phi 200,$ and $\phi 250$ steel tube types. Sensor switches cannot be used.

2: When operating temperature is 60°C or higher, select **F** or **FJ**.

3: The strokes defined below for $\phi 160, \phi 180, \phi 200,$ and $\phi 250$ cylinder bores should be treated as Class 2 pressure vessel.

$\phi 160$: (Stroke 1 x 2) + Stroke 2 ≥ 1894 mm, $\phi 180$: (Stroke 1 x 2) + Stroke 2 ≥ 1474 mm, $\phi 200$: (Stroke 1 x 2) + Stroke 2 ≥ 902 mm

$\phi 250$: (Stroke 1 x 2) + Stroke 2 ≥ 693 mm

Available strokes are different in the case of cylinder with bellows and when trunnion type (**-11, -11T**) is selected for the mounting type.

4: One rod end nut equipped.

5: Trunnion brackets are equipped on the Stroke 1 + 2 side.

Tandem cylinder operation

A tandem cylinder has two cylinders that are joined in series.

Supplying air to the A port or B port allows it to operate as a two-stage stroke cylinder, and twice as much thrust can be obtained within the range of stroke 1.

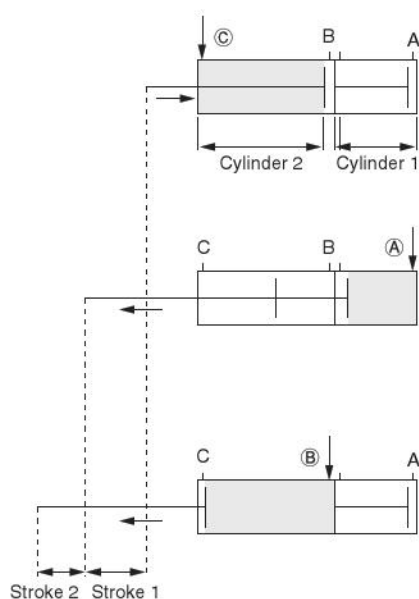

When air pressure is supplied via the © port, the rod retracts strokes of stroke 2 and 1.

When air pressure is supplied via the Ⓐ port, the rod extends stroke of stroke 1.

When air pressure is supplied via the Ⓑ port, the rod extends stroke of stroke 2.

Mass

Cylinder bore mm	Zero stroke mass									Stroke 1 Additional mass per 1 mm	Stroke 2 Additional mass per 1 mm	Mass of one sensor switch (with holder)				Additional mass	
	Basic Type	Foot Type	Flange Type	Clevis Type (with pin)	Clevis Type (with supporting bracket)	Eye Type	Trunnion Type	Trunnion Type (with supporting bracket)	CS□T, ZC130			ZC153		Y-knuckle (with pin)	I-knuckle		
									A			B	A			B	
125	33.93 (28.61)	35.93 (30.61)	36.51 (31.19)	34.69 (29.37)	37.29 (31.97)	34.50 (29.18)	36.13 (30.81)	39.18 (33.86)	0.0484 (0.0308)	0.0242 (0.0154)	0.038	0.062	0.039	0.066	1.47	1.24	
140	50.98 (42.92)	53.81 (45.75)	55.36 (47.30)	52.70 (44.64)	60.50 (52.44)	51.92 (43.86)	55.98 (47.92)	64.13 (56.07)	0.0796 (0.0446)	0.0398 (0.0223)	0.053	0.077	0.054	0.081	3.32	2.40	
160	63.35 (53.39)	66.57 (56.61)	68.83 (58.87)	65.17 (55.21)	72.97 (63.01)	64.70 (54.74)	68.30 (58.34)	76.45 (66.49)	0.0730 (0.0444)	0.0365 (0.0222)	0.053	0.077	0.054	0.081	3.32	2.40	
180	82.81	88.50	90.03	84.53	92.33	84.06	88.81	96.96	0.1070	0.0535	—	—	—	—	3.32	2.40	
200	95.83	101.95	104.13	97.55	105.35	97.08	102.13	110.28	0.1186	0.0593	—	—	—	—	3.32	2.40	
250	180.26	188.64	195.96	184.48	201.13	183.49	190.76	206.26	0.1270	0.0635	—	—	—	—	5.93	4.62	

Note: Values in parentheses are for the KBSDT aluminum tube type.

Basic Type Dimensions (mm)

KBSDTS **Cylinder bore** × **Stroke 1** × **Stroke 2**

KCSDT **Cylinder bore** × **Stroke 1** × **Stroke 2**

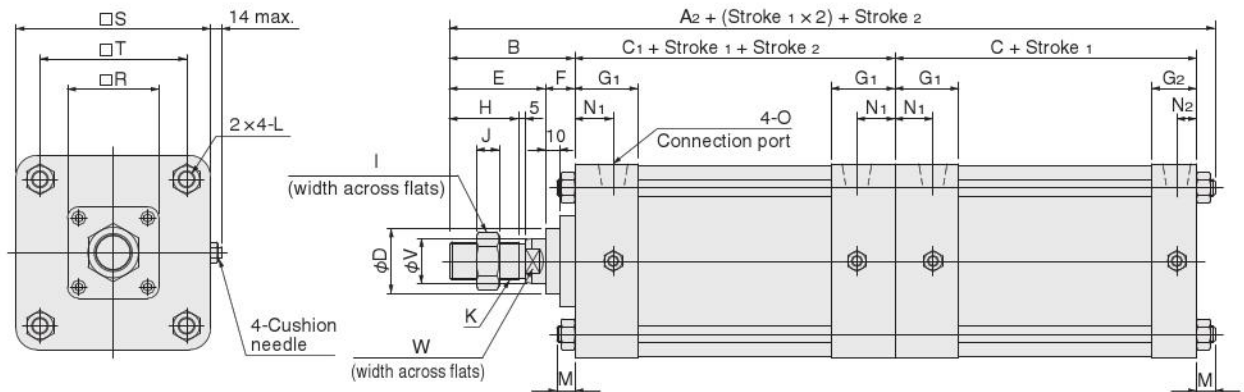

Bore	Symbol	A ₂	B	C	C ₁	D	E	F	G ₁	G ₂	H	I	J	K
125		343	89	114	127	46	68	21	45	32	49	36	16	M27×2
140		403	113	131	143	55	88	25	50	38	67	50	20	M36×2
160		403	113	131	143	55	88	25	50	38	67	50	20	M36×2
180		403	113	131	143	55	88	25	50	38	67	50	20	M36×2
200		403	113	131	143	55	88	25	50	38	67	50	20	M36×2
250		482	132	162	169	60	102	30	57	50	79	60	22	M42×2

Bore	Symbol	L	M	N ₁	N ₂	O	R	S	T	V	W
125		M12×1.5	13	27	14	Rc1/2	65	138	104	32	27
140		M16×1.5	16	29	17	Rc3/4	76	156	123	40	36
160		M16×1.5	16	29	17	Rc3/4	76	178	134	40	36
180		M16×1.5	16	29	17	Rc3/4	76	200	156	40	36
200		M16×1.5	16	29	17	Rc3/4	76	216	163	40	36
250		M20×1.5	19	30	23	Rc1	90	270	202	45	41

Rod end accessories

Y-knuckle dimensions (mm)

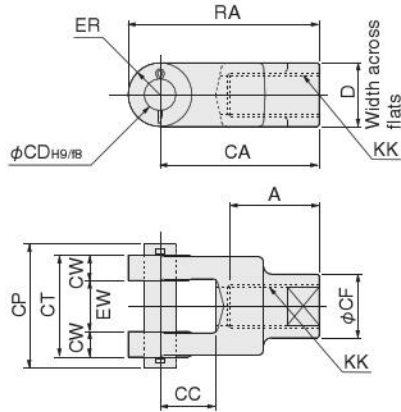

Bore	Symbol	Part number	A	CA	CC	CD	CF	CP	CT	CW	D	ER	EW	KK	RA
	125	Y-KSD-M27	56	100	35	20	40	78	64	16	40	R20	$32^{+1.5}_{-0.5}$	M27×2	120
	140	Y-KSD-M36	74	125	36.5	28	55	97	80	20	55	R27.5	$40^{+1.5}_{-0.5}$	M36×2	152.5
	160	Y-KSD-M36	74	125	36.5	28	55	97	80	20	55	R27.5	$40^{+1.5}_{-0.5}$	M36×2	152.5
	180	Y-KSD-M36	74	125	36.5	28	55	97	80	20	55	R27.5	$40^{+1.5}_{-0.5}$	M36×2	152.5
	200	Y-KSD-M36	74	125	36.5	28	55	97	80	20	55	R27.5	$40^{+1.5}_{-0.5}$	M36×2	152.5
	250	Y-KSD-M42	86	144	49	36	70	117	100	25	65	R35	$50^{+1.5}_{-0.5}$	M42×2	179

I-knuckle dimensions (mm)

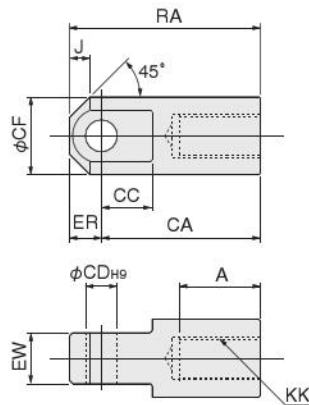

Bore	Symbol	Part number	A	CA	CC	CD	CF	ER	EW	J	KK	RA
	125	I-KSD-M27	51	100	32	20	49	R20	$32^0_{-0.1}$	13	M27×2	120
	140	I-KSD-M36	69	125	33	28	62	R28	$40^0_{-0.1}$	18	M36×2	153
	160	I-KSD-M36	69	125	33	28	62	R28	$40^0_{-0.1}$	18	M36×2	153
	180	I-KSD-M36	69	125	33	28	62	R28	$40^0_{-0.1}$	18	M36×2	153
	200	I-KSD-M36	69	125	33	28	62	R28	$40^0_{-0.1}$	18	M36×2	153
	250	I-KSD-M42	81	144	48	36	79	R36	$50^0_{-0.1}$	20	M42×2	180

Bellows

Bellows Dimensions (mm)

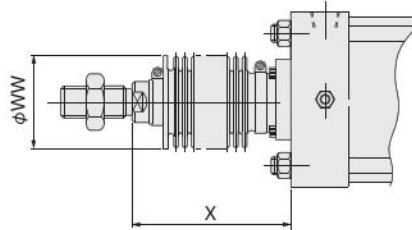

With bellows (Nylon tarpaulin, chloroprene)

Bore	Symbol	WW	X (standard stroke)											X (non-standard stroke)	
			50	75	100	125	150	200	250	300	350	400	450	500	Nylon tarpaulin, chloroprene
125		71	84	90	96	103	109	121	134	146	159	171	184	196	1/4 Stroke +71
140		80	88	94	100	107	113	125	138	150	163	175	188	200	1/4 Stroke +75
160		80	88	94	100	107	113	125	138	150	163	175	188	200	1/4 Stroke +75
180		80	88	94	100	107	113	125	138	150	163	175	188	200	1/4 Stroke +75
200		80	88	94	100	107	113	125	138	150	163	175	188	200	1/4 Stroke +75
250		80	93	99	105	112	118	130	143	155	168	180	193	205	1/4 Stroke +80

With bellows (Conex)

Bore	Symbol	WW	X (standard stroke)											X (non-standard stroke)	
			50	75	100	125	150	200	250	300	350	400	450	500	Conex
125		71	88	96	105	113	121	138	155	171	188	205	221	238	1/3 Stroke +71
140		80	92	100	109	117	125	142	159	175	192	209	225	242	1/3 Stroke +75
160		80	92	100	109	117	125	142	159	175	192	209	225	242	1/3 Stroke +75
180		80	92	100	109	117	125	142	159	175	192	209	225	242	1/3 Stroke +75
200		80	92	100	109	117	125	142	159	175	192	209	225	242	1/3 Stroke +75
250		80	97	105	114	122	130	147	164	180	197	214	230	247	1/3 Stroke +80

● Bellows Specifications

Type	Specifications	Description	Heat-resistant temperature °C
Made of nylon tarpaulin	Vinyl-coated nylon cloth		80
Made of chloroprene	Chloroprene-coated nylon cloth		100
Made of Conex	Silicon-coated Conex cloth (asbestos not used)		100

- Note 1: Conex is a registered trademark of Teijin Limited.
 2: Fractional values are cut off to the nearest whole number.
 3: The dust cover is attached to the cylinder when shipped.
 4: The X dimension is from the end of the cover. Keep this in mind in the case of a flange bracket.

Option Order Codes

(1) Y-, I-knuckle



(2) Rod end nut



(3) Pins for Y-knuckle and clevis (with two cotter pins)



(4) Supporting bracket for Trunnion Type and Clevis Type

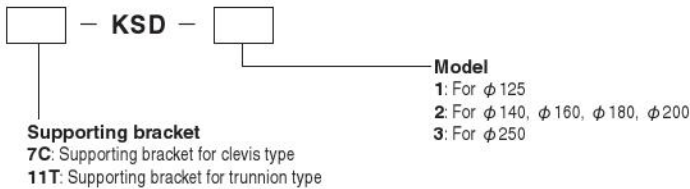

(5) Packing set

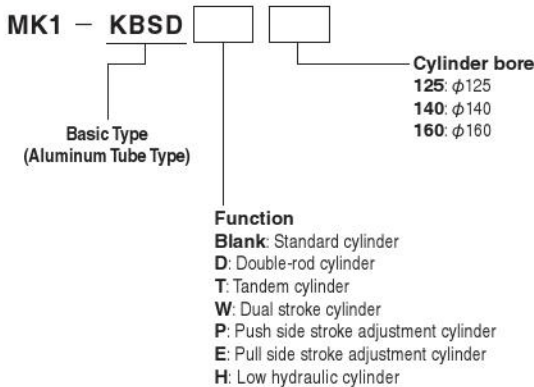

Note: The packing set includes a wear ring.

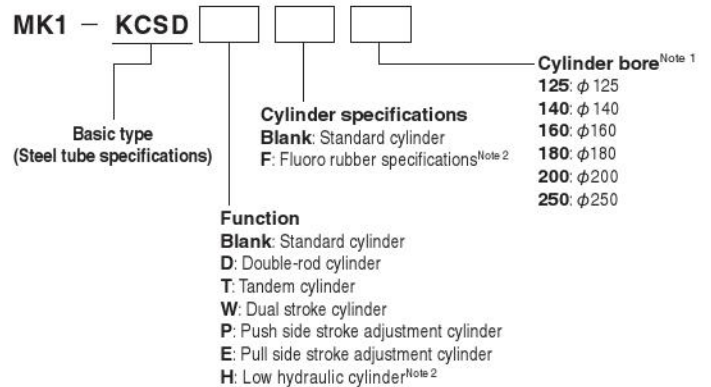

Note 1: The cylinder bores of pull side stroke adjustment cylinders are φ 125, φ 140, and φ 160. The cylinder bores of low hydraulic cylinders are φ 180, φ 200, and φ 250.

Note 2: Fluoro rubber specifications not available for low hydraulic cylinders.

Note: The packing set includes a wear ring.



When replacing packing, be sure to read the precautions under "Disassembly and replacement" on page 6.

Sensor switch

Solid State Type, Reed Switch Type

Symbol



Order code examples

● Order codes for sensor switches only (without sensor holders)

● Order codes for sensor holders only

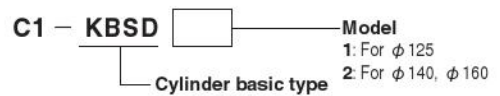
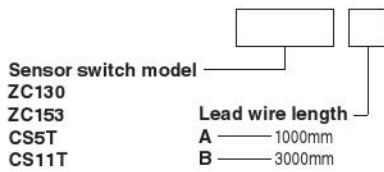

Minimum Cylinder Stroke for Sensor Switch Use

Sensor switch model		Cylinder bore	Non-trunnion Type	Trunnion Type
Solid State Type	ZC130	125	16	108
	ZC153	140, 160	14	119
Reed Switch Type	CS5T	125	17	110
		140, 160	14	120
	CS11T	125	15	106
		140, 160	12	116

Note: When two sensor switches are attached, one on each tie rod.

Sensor Switch Operating Range, Response Differential, and Maximum Sensing Location

● Operating range: ℓ

The distance the piston travels in one direction, between turning ON the sensor switch and turning it OFF.

● Response differential: C

The distance between the point where the piston turns the switch ON and the point where the switch is turned OFF as the piston travels in the opposite direction.

Sensor switch model	Solid State Type	Reed Switch Type	
	ZC130·ZC153	CS5T	CS11T
Operating range: ℓ	5 ± 1.5	12.5 ± 3	
Response differential: C	1 MAX.	3 MAX.	
Maximum sensing location ^{Note}	8.5	7	10.5

Note: Distance from the indicator end face at the opposite end of the lead wire.

Note: The values in the table above are reference values at normal temperature (25°C).

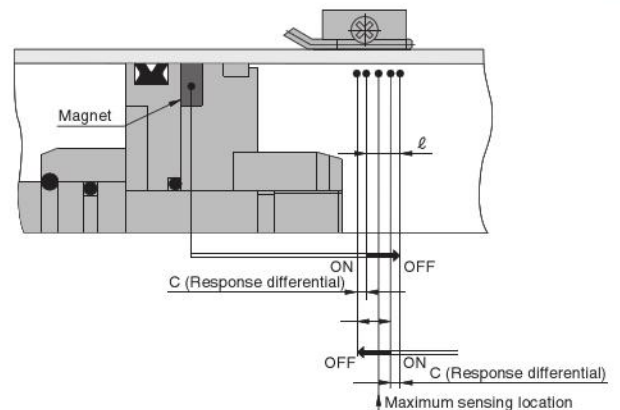

Sensor switch mounting position

When the sensor switch is mounted in the locations shown in the diagram below (table shows reference dimensions), the sensor magnet comes to the maximum sensing location of the sensor switch at the end of the stroke.

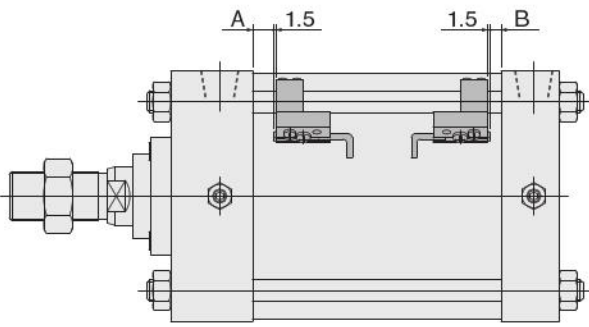

Sensor switch model		Position	mm Cylinder bore		
			φ125	φ140	φ160
Solid State Type	ZC130	A	11.5	15	15
	ZC153	B	7.5	10.5	10.5
Reed Switch Type	CS5T	A	12	15.5	15.5
		B	9	11.5	11.5
	CS11T	A	10	13.5	13.5
		B	7	9.5	9.5

Note 1: Mounting the sensor switch with the lead wire facing the outside (opposite the direction shown in the diagram) will prevent the stroke end from reaching the maximum sensing location.

Note 2: In the case of a trunnion type, set the maximum sensitivity position so it is at least 15 mm from the trunnion bracket.

Sensor Switch Dimension Diagram (mm)

●Precautions during mounting

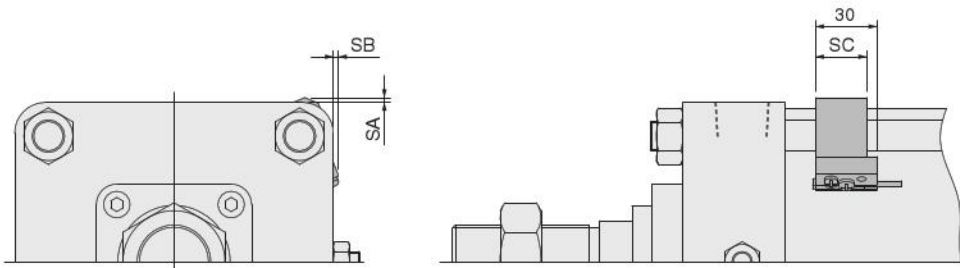
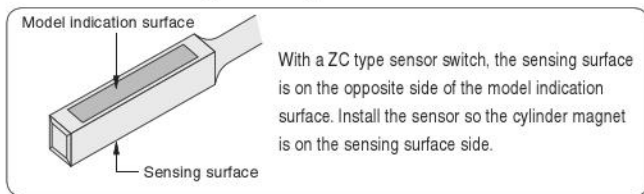

Bore	Symbol	SA	SB	SC
125		0	6	15
140		2.5	3	25
160		0	0	25

Guidelines for connecting, disconnecting, and moving sensor switches

●Be sure to read the precautions before mounting the sensor switch on the KSD cylinder series to ensure correct mounting and usage.

Items required to attach one sensor switch to a cylinder

- ① Sensor switch
- ② Washer × 1
- ③ Screw (short) × 1
- ④ Sensor holder × 1
- ⑤ Set screw × 2
- ⑥ Tie rod
- ⑦ Screw (long) × 1
- ⑧ Sub-holder × 1
- ⑨ Hex wrench

For φ125: Width across flats 2 mm
For φ140, φ160: Width across flats 3 mm

Note: The sensing surface of a sensor switch is on the opposite side of the model indication surface. Install the sensor so the cylinder tube is on the sensing surface side. Installing the sensor so the model indication surface is downwards (on the cylinder tube side) or to the side can result in improper operation.

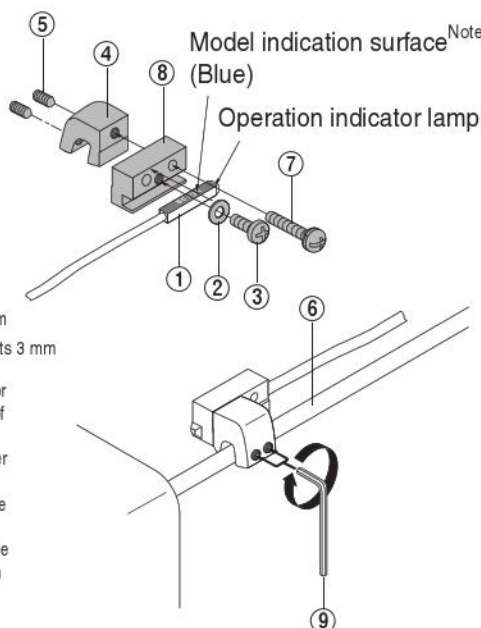

1. ● Aligning the sensor holder ④ female thread with the sub-holder ⑧ through hole, use a screw (long) ⑦ to assemble them together.
 - The sub-holder ⑧ has two through holes, and either one can be used.
 - The appropriate tightening torque for the screw (long) ⑦ is 70 N·cm.
2. ● Use a screw (short) ③ and washer ② to install the sensor switch ①, with its model indication surface facing upwards, into the groove of the sub-holder ⑧.
 - Aligning the sensor switch ① and the operation indicator lamp (or cap) boundary with the end face of the sub-holder ⑧, assemble them together. To protect the sensor switch ① against damage, be sure that its body does not extend past the end face of the sub-holder ⑧.
 - The appropriate tightening torque for ③ small screw (short) is 70 N·cm.
3. ● The sensor holder ④ is temporarily fastened by two set screws ⑤.
 - Place the sensor holder ④, and the assembled sensor switch ① and sub-holder ⑧ onto the tie rod ⑥, aligning it with the prescribed location. Next, use a hex wrench ⑨ to tighten the two set screws ⑤ and secure the assembly in place. Make sure that the bottom surface of the sub-holder ⑧ is in contact with the cylinder tube.
 - The appropriate tightening torque for the two set screws ⑤ is 70 N·cm in the case of φ125, and 200 N·cm in the case of φ140 and φ160.
 - A cylinder has four tie rods ⑥, and you can install the sensor holder ④ on any one of them. Also, the orientation of the sensor holder ④ when it is attached is optional.
 - The sensor holder ④ can be repositioned by sliding it along the tie rod ⑥ after loosening the two set screws ⑤.

ZC130□ · ZC153□



Solid state sensor switch

Specifications

Item	Model	ZC130□	ZC153□
Wiring type		2-lead wire	3-lead wire
Power supply voltage		-	4.5 to 28 VDC
Load voltage		10 to 28 VDC	4.5 to 28 VDC
Load current		4 to 50 mA	100 mA MAX.
Consumption current		-	10 mA max. (at 24 VDC)
Internal voltage drop ^{Note 1}		3.5 V MAX.	0.5 V MAX. (for load current of 50 mA DC)
Leakage current		1 mA max. (at 24 VDC)	50 μA max. (at 24 VDC)
Response time		1 ms MAX.	
Insulation resistance		100 MΩ MIN. (at 500 VDC Megger, between case and lead wire terminal)	
Dielectric strength		500 VAC (50/60 Hz) in 1 minute (between case and lead wire terminal)	
Shock resistance ^{Note 2}		294.2 m/s ² (non-repeated)	
Vibration resistance ^{Note 2}		88.3 m/s ² (total amplitude 1.5 mm, 10 to 55 Hz)	
Environmental protection		IP67 (IEC standard), JIS C0920 (watertight type)	
Operation indicators		When ON, a red LED indicator lights up	
Wires ^{Note 3}		PVC 0.2SQ×2 wires× ℓ	PVC 0.2SQ×3 wires× ℓ
Ambient temperature		0 to 60°C	
Storage temperature range		-10 to 70°C	
Mass		20 g (When lead wire length is A=1000 mm.)	

Note 1: Internal voltage drop changes with the load current.

2: According to KOGANEI test standards.

3: Lead wire length ℓ: A is 1000 mm, B is 3000 mm

※ This product is not resistant to lightning surge of the EMC standard (EN61000-6-2 · EN60947-5-2).

Prepare protection measures for lightning surge in the system.

Inner circuits

ZC130□

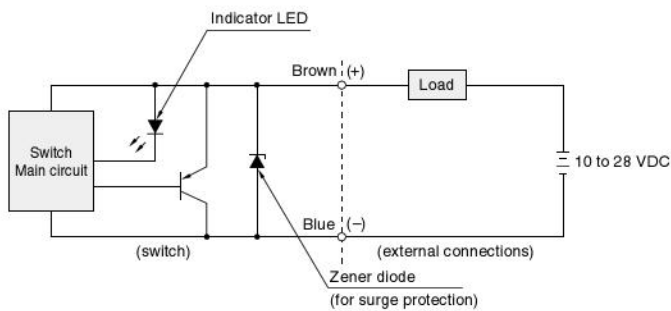

ZC153□

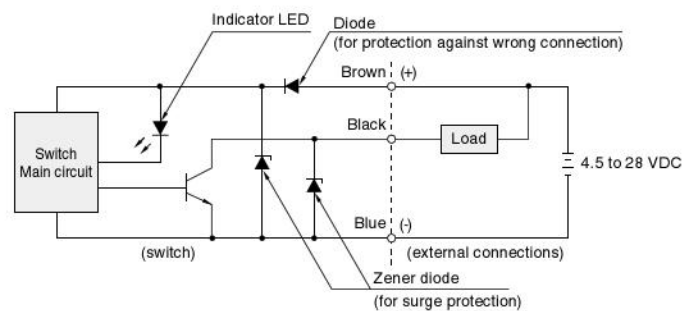

Dimensions (mm)

ZC130□

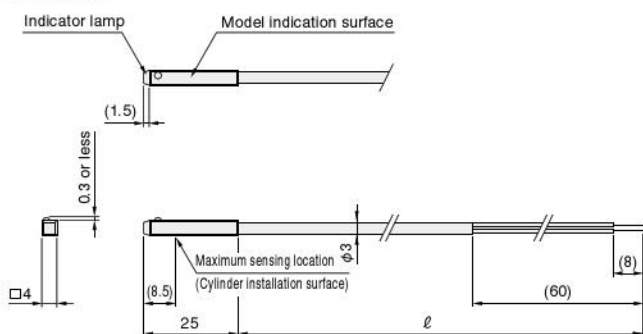

ZC153□

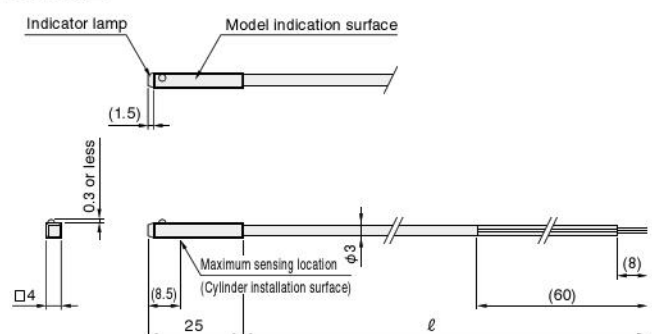

CS5T□ · CS11T□



Reed sensor switch

Specifications

Item	Model	CS5T □	CS11T □
Wiring type		2-lead wire	
Load voltage		5 to 28 VDC, 85 to 115 VAC (r.m.s.)	10 to 28 VDC
Load current		0.1 to 40 mA DC, 2 to 25 mA AC	5 to 40 mA DC
Internal voltage drop ^{Note 1}		0.1 V MAX (for load current of 40 mA DC)	2.1 V MAX (for load current of 40 mA DC)
Leakage current		0 mA	
Response time		1 ms MAX.	
Insulation resistance		100 MΩ MIN. (at 500 VDC Megger, between case and lead wire terminal)	
Dielectric strength		1500 VAC (50/60 Hz) for 1 minute (between case and lead wire terminal)	1000 VAC (50/60 Hz) for 1 minute (between case and lead wire terminal)
Shock resistance ^{Note 2}		294.2 m/s ² (non-repeated)	
Vibration resistance ^{Note 2}		88.3 m/s ² (total amplitude 1.5 mm, 10 to 55 Hz), resonance frequency 2750 ± 250 Hz	
Environmental protection		IP67 (IEC standard), JIS C0920 (watertight type)	
Operation indicators		–	When ON, a red LED indicator lights up
Wires ^{Note 3}		PVC 0.2SQ×2 wires× ℓ	
Ambient temperature		0 to 60°C	
Storage temperature range		–10 to 70°C	
Contact protection measure		Required (See the information about contact protection on page 46.)	
Mass		20 g (When lead wire length is A=1000 mm.)	

Note 1: Internal voltage drop changes with the load current.
 Note 2: According to KOGANEI test standards.
 Note 3: Lead wire length ℓ : A is 1000 mm, B is 3000 mm

Inner circuits

CS5T□

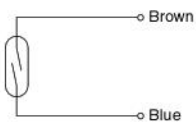

CS11T□

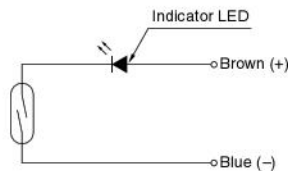

Dimensions (mm)

CS5T□

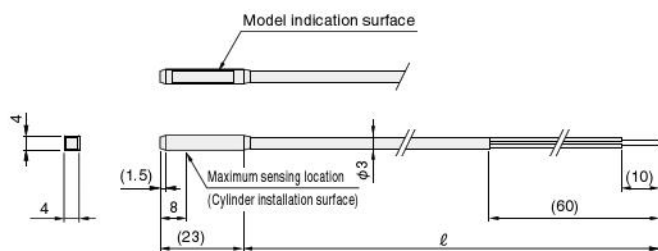

CS11T□

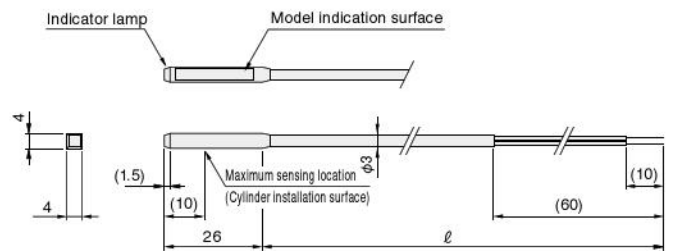

Wiring instructions for the solid state sensor switches

ZC130

Basic connection

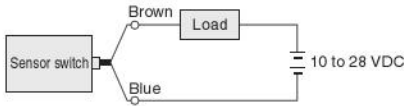

Connecting with relays

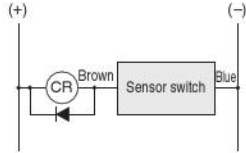

AND (series) connection and OR (parallel) connection

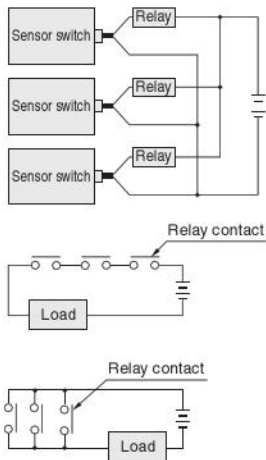

ZC153

Basic connection

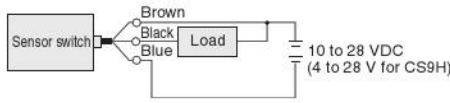

Connecting with relays

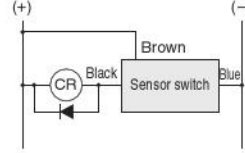

AND (series) connection and OR (parallel) connection

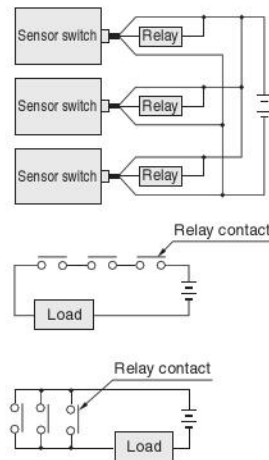

Connecting with TTL

Isolated connection

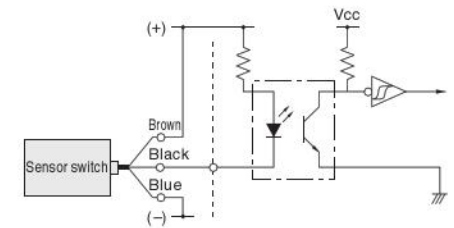

Direct connection

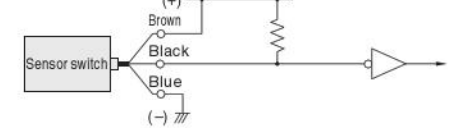

Connecting with a solenoid valve

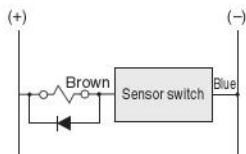

Connecting with a solenoid valve

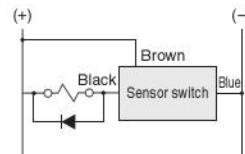

Connecting with C-MOS

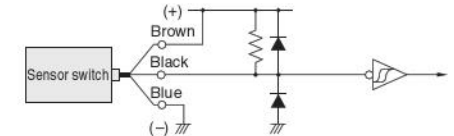

Connecting with a programmable controller

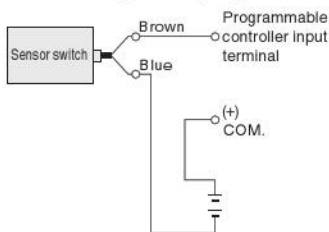

Connecting with a programmable controller

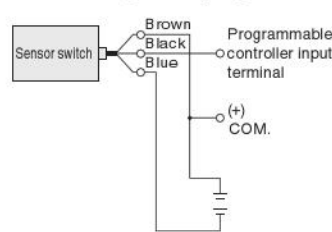

1. Connect the lead wires according to their color. Incorrect connection could lead to breakdown and damage.
2. Do not connect a two-lead wire solid state sensor switch with a TTL or C-MOS.
3. The use of a surge protection diode is recommended with the inductive load such as an electromagnetic relay.
4. Avoid the use of series (AND) connections, because the circuit voltage will drop in proportion to the number of sensor switches.
5. When using an OR connection, it is possible to connect both sensor outputs directly (ex: using corresponding black lead wires). Be aware of load return errors since current leakage increases with the number of sensors.

6. Because the sensor switches are magnetically sensitive, avoid using them in locations subject to strong external magnetic fields or bringing them in close proximity to power lines and areas where large electric currents are present. In addition, do not use magnetized materials for the mounting bracket. It could result in erratic operation.
7. Do not excessively pull on or bend the lead wires.
8. Avoid using the switches in environments where chemicals or gas is present.
9. Consult the nearest KOGANEI sales office for information about use in environments subject to water or oil.

Contact Protection for Reed Switch Type Sensor Switch

In order to use a reed sensor switch with stability, observe the contact protection measures listed below.

● For connecting an inductive load (electromagnetic relay etc.)

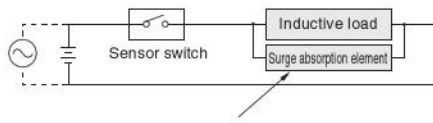

DC... Diode or CR, etc.

AC... CR, etc.

Diode: Forward current should be more than circuit current, and reverse voltage should be at least 10 times greater than circuit voltage.

CR: C=0.01 to 0.1 μ F

R=1 to 4 k Ω

● For capacitive surges

(When lead wire length exceeds 10 m)

