

1-channel Flow Rate Sensor Controllers

FS1U Series

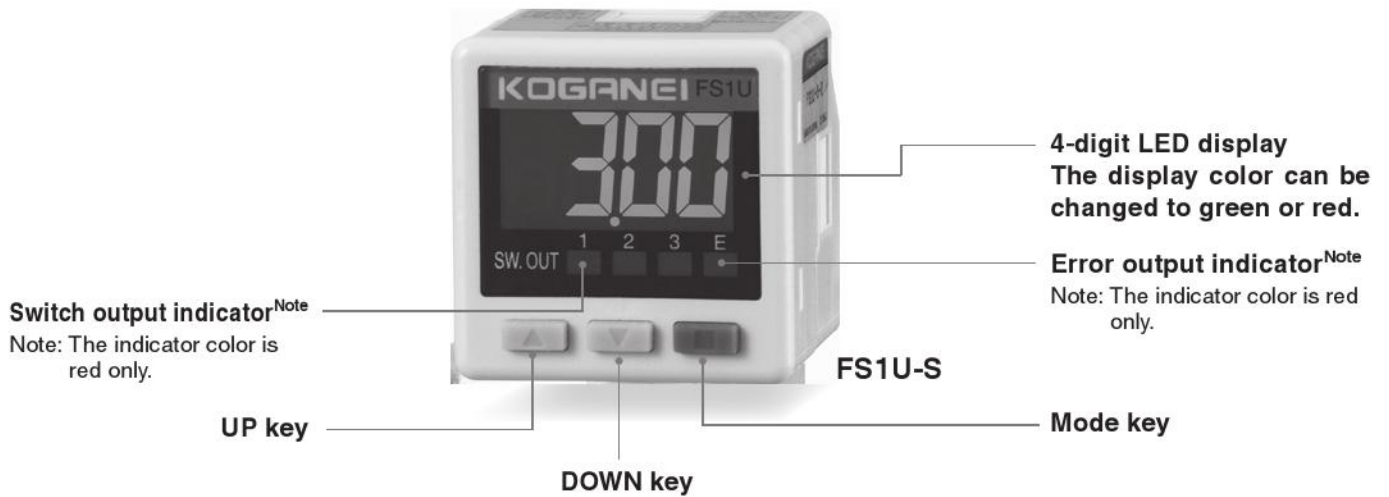

The same ease of use as a pressure switch

- A variety of output modes and functions allows usage similar to a pressure sensor.
- 2-color indicator for at-a-glance check of workpiece suction.



Example: Photograph shows switch output ON.

Computer connectible

- Flow rate setting, flow rate value importing, and reference flow rate setting can be configured on a computer.



■ Window comparator mode 1

- Mode for free setting of L1 and L2. However, switch output does not turn ON during flow rate increase.

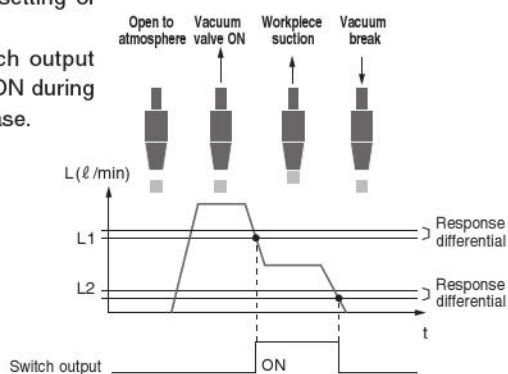

■ Window comparator mode 2 and 3

- Mode for auto setting of L1 in accordance with ΔL setting and reference flow rate import. (L1 = Reference flow rate - ΔL)

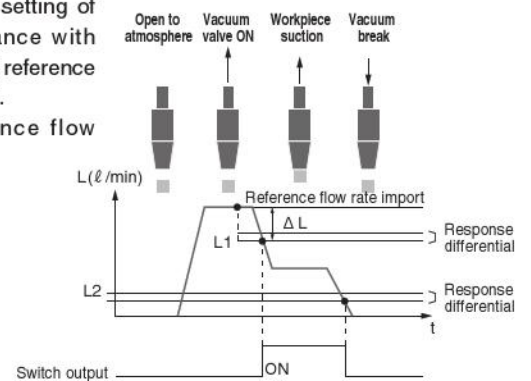

Do you have any problems with workpiece suction?

The Flow rate sensor detects workpieces lifted by vacuum that could not be detected by the pressure sensor.

Made compatible with the separate type multi-channel flow rate sensor controller

- Used sensor head, operation method, and setting commands are made compatible with each other.
- Three sensor head types: - 500 to 500 m³ /min (ANR) [-30.512 to 30.512 in³/min], - 3 to 3 ℓ /min (ANR) [-0.106 to 0.106 ft³/min], and 0 to 10 ℓ /min (ANR) [0 to 0.353 ft³/min].



Sensor head



Separate type multi-channel Flow rate sensor controller

RS-232C communication type and output type available

- Flow rate can be constantly monitored by RS-232C or analog output.
- RS-232C type: Flow rates in ASCII can be imported.
- Analog output type: Flow rates can be imported using analog voltage.

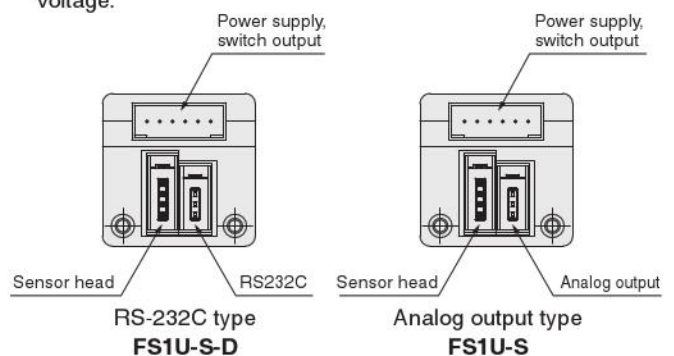

No piping resistance effect

- To avoid the effects of piping resistance, there is no limit on the flow rate sensor head mounting position.

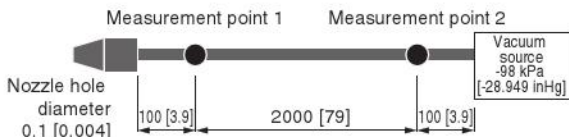

Measurement results using ϕ 1.8 [0.071] tubes

	Measurement point 1	Measurement point 2
Flow rate sensor	0.11 ℓ /min [0.004 ft ³ /min]	0.12 ℓ /min [0.004 ft ³ /min]
Pressure sensor	-78 kPa [-23.041 inHg]	-95 kPa [-28.063 inHg]

* According to Koganei test standards.

Window comparator mode 4

- Mode for free setting of L1 and L2.

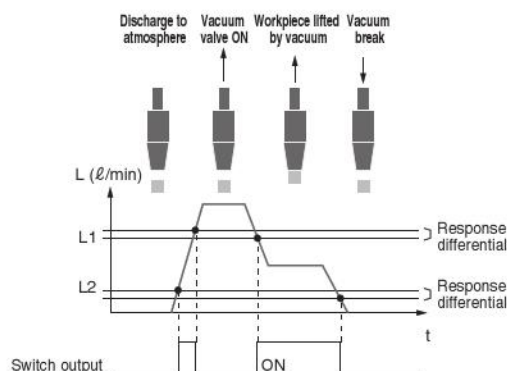

Hysteresis mode

- In this mode, switch output is ON in the case of L1 or higher, and OFF in the case of L2 or lower.

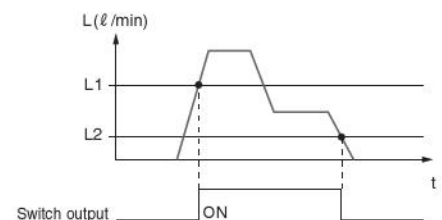

Window comparator mode 2

- In this mode, once L1 is set it does not change until the reference flow rate is imported again.

Window comparator mode 3

- In this mode, each time the L1 setting is deleted when switch output goes OFF, this mode performs reference flow rate capture and sets L1. Effective for situations where flow rate fluctuation is severe.

When using window comparator mode 3, import a reference flow rate from an external source via RS-232C, etc.

Safety precautions (1-channel Flow Rate Sensor Controllers)

Safety precautions specific to 1-channel Flow Rate Sensor Controllers are shown below. Be sure to read the material in the front of the General Personal Catalog regarding safety precautions other than those below.

DANGER

- While the product is in operation, do not attempt to adjust the attached mechanisms (connecting and disconnecting the wiring connector, or attach or position the sensor head, etc.). Abnormal operations could result in injury.

WARNING

- While the 1-channel Flow Rate Sensor Controller is in operation, do not apply an external magnetic field to the controller and sensor head. This could cause unintentional operation leading to damage to equipment or to personal injury.
- When wiring, be careful to ensure that the wiring polarity is correct.
A wrong polarity could result in damage to the 1-channel Flow Rate Sensor Controller.

CAUTION

- Always use the specified sensor head with this product.
Use of an unspecified item could result in erratic operation.
- When handling the 1-channel Flow Rate Sensor Controller and sensor head, avoid hitting, dropping, or bumping with excessive force (294 m/s² [30 G] or more). Even if not apparently damaged, the internal parts could be damaged, leading to erratic operation.
- Do not short the load.
Switching on sensor output with a shorted load could cause damage to the 1-channel Flow Rate Sensor Controller due to overcurrent.
Example of load shorting: Connecting the output lead wires for sensor output directly to the power supply.
- When mounting the fitting to the sensor head, the tightening torque should not exceed 2.5 N·m [22.128 in·lbf]. In addition, when securing the sensor head, use an M3 screw and the tightening torque should not exceed 0.6 N·m [5.311 in·lbf].
Excessive tightening could damage the sensor head, etc.
Always switch off the power before connecting the sensor head and controller. Attempting to connect the sensor head with the power on could cause erratic operation in the controller due to surge voltage, etc.

Handling Instructions and Precautions



General precautions

Wiring

1. If power is supplied from a commercial switching regulator, ensure that the frame ground (F.G.) terminal of the power supply is connected to an actual ground.
2. In the case of noise generating equipment (switching regulator, inverter motor, etc.) being used in the vicinity of sensor mounting portion, connect the frame ground (F.G.) terminal of the equipment to an actual ground.
3. When wiring is completed, check that there is no error in the wiring connections.

Other

1. Sensor head is designed for use with non-corrosive gas. It cannot be used for liquid or corrosive gas.
2. Use within the rated voltage range for power supply.
3. Do not use during the initial transient time (0.5 sec.) after the power supply is switched on.
4. Do not operate the keys with pointed or sharp objects.
5. When using window comparator mode 2 in operations that capture repeated utilization of the reference flow rate, the guaranteed number of times may be exceeded in a short period of time. In such cases, use window comparator mode 3.
6. If using with window comparator mode 3, use FSU-S-D.

Handling Instructions and Precautions



Mounting and Wiring

Sensor head and connector connection procedure

When the sensor head FS-□ is supplied, the sensor head body and mini clamp connector (male) are not yet connected. Follow the procedure below to perform the connection.

1. Check that the connector cover (the part where lead wires are to be inserted) is protruding from the connector body. It cannot be used if it is flat and placed at the same level against the body.

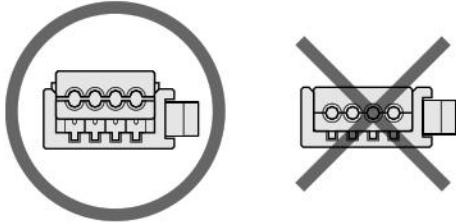

2. Cut the cable at the length required for the sensor head. Strip off the cable sheath for 50 mm [1.969 in] from the cable end, and expose the lead wires. At this time, do not take off the lead wire insulation.

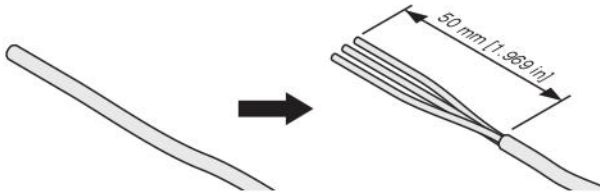

3. Follow the instructions in the table below to insert the lead wires into the hole in the connector cover. Look through the top of the semi-transparent cover to check that the lead wires have been firmly inserted all the way to the back. (Insertion length is about 9 mm [0.354 in].) Use caution in making the connections, since switching on the power with wrong connections will damage the sensor head and controller.

Number on connector	Signal name	Lead wire color
1	Sensor head power supply (+)	Sensor head brown wire
2	Sensor head voltage output	Sensor head black wire
3	Sensor head power supply (0 V)	Sensor head blue wire
4	Reference flow rate capture	Prepared by customer AWG 24-26 (0.14-0.3sq) Insulation diameter: φ0.8 ~ 1.0 mm (0.031 ~ 0.039 in)

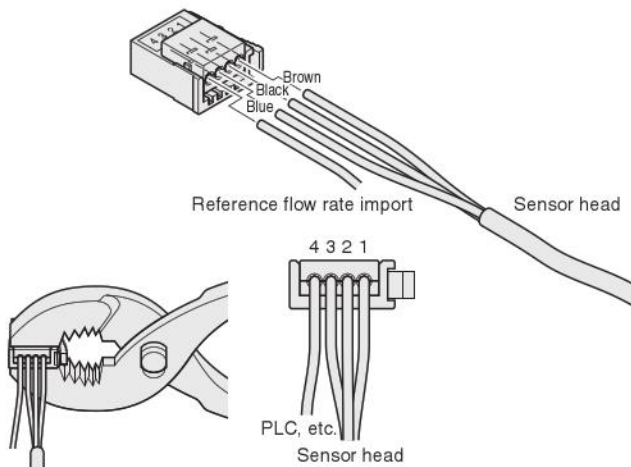

4. Taking care to avoid letting the lead wires slip out from the connector, use pliers or some other hand tool to crimp the cover and connector body, and push the cover into the connector body. Limit the crimping force to 980.7 N [220.5 lbf]. When the cover is flat and placed at the same level against the connector body, the connection is complete.
5. Perform the same process on the mini connectors (male, female) of the FS1UK-□ junction cable.
6. Check one more time that the wiring is correct.

7. On the sensor head body, connect the sensor head-side connector. Open the sensor head cover, connect the connector, and then close the cover.

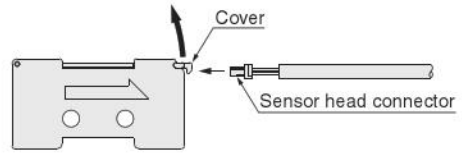

Communication/analog output cable connector connection instructions

When a communication/analog output cable is delivered, the cable and mini clamp connector (male) are not connected. Use the procedure below to connect them.

1. Check that the connector cover (the part where lead wires are to be inserted) is protruding from the connector body. It cannot be used if it is flat and placed at the same level against the body.

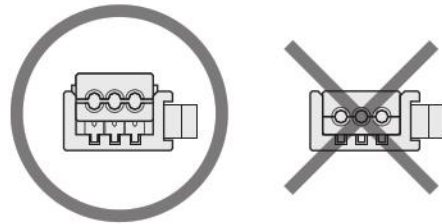

2. Cut the cable at the length required for the sensor head. Strip off the cable sheath for 50 mm [1.969 in] from the cable end, and expose the lead wires. At this time, do not take off the lead wire insulation.

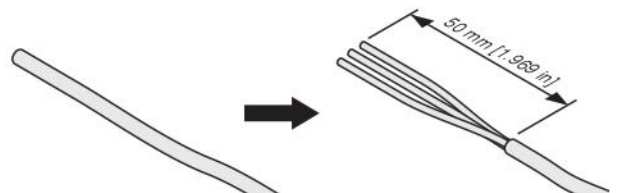

3. Follow the instructions in the table below to insert the lead wires into the hole in the connector cover. Look through the top of the semi-transparent cover to check that the lead wires have been firmly inserted all the way to the back. (Insertion length is about 9 mm [0.354 in].) Use caution in making the connections, since switching on the power with wrong connections will damage the sensor head and controller.

Number on connector	Connection wire color	Signal name (FS1U-S)	Signal name (FS1U-S-D)
1	Black	Analog output	TXD
2	Brown	Zero reset input	RXD
3	Blue	0 V	0 V

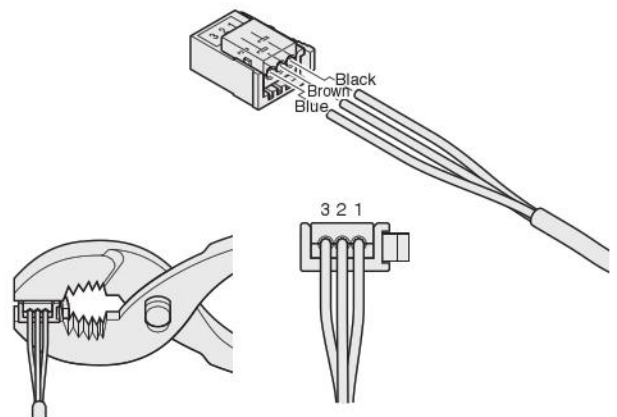

4. Taking care to avoid letting the lead wires slip out from the connector, use pliers or some other hand tool to crimp the cover and connector body, and push the cover into the connector body. Limit the crimping force to 980.7 N [220.5 lbf]. When the cover is flat and placed at the same level against the connector body, the connection is complete.
5. Check one more time that the wiring is correct.

Handling Instructions and Precautions

Attaching and removing cables for sensor head, power, and switch output, and for communication and analog output

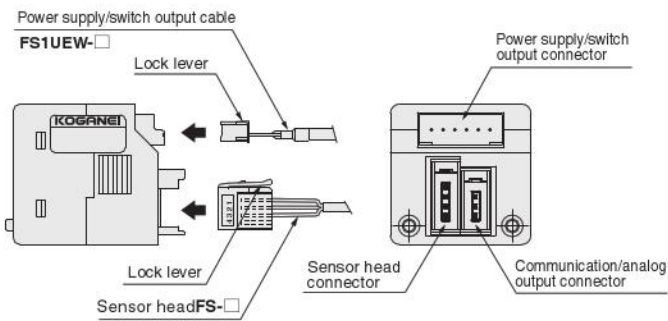

To attach the sensor head, the power supply/switching output, and communication/analog output cables, position the lock levers as shown in the illustration, and then insert until they lock into place with the controller side connectors.

To disconnect, press the lock lever down sufficiently as you pull the connector to unplug it. At this time, take care not to apply undue force to the lead wires.

When using the **FS1U-S** (without RS-232C), do not connect the communication/analog connector to the RS-232C port of the control equipment you are using. Doing so creates the risk of damage to the control equipment you are using.

Note: The **FS1U-S-□** can be used even when the communication/analog output cable is not connected.

Attaching parts for panel mount and the protective front cover

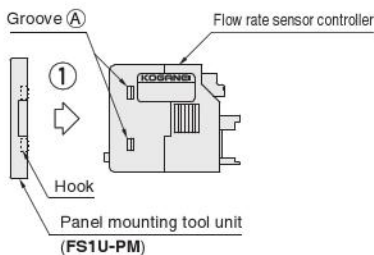

① Attach the panel mounting tool unit to the front panel of the flow rate sensor controller. Attach the panel mounting tool unit so the inside tabs enter the slots (A) on the flow rate sensor controller.

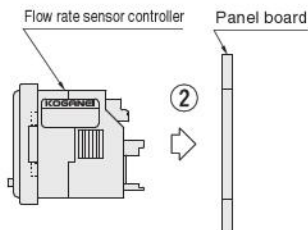

② Insert the flow rate sensor controller from the panel hole front side.

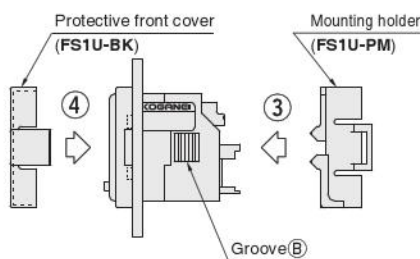

③ On the back side of the configuration resulting from ② above, insert the mounting holder while hooking it on the flow rate sensor controller grooves (B).

④ Set the protective front cover in place.

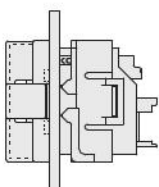

* When removing the components, perform the steps above in reverse order. Use a screw driver or another tool to remove the mounting holder.

Mounting the bracket and protective front cover

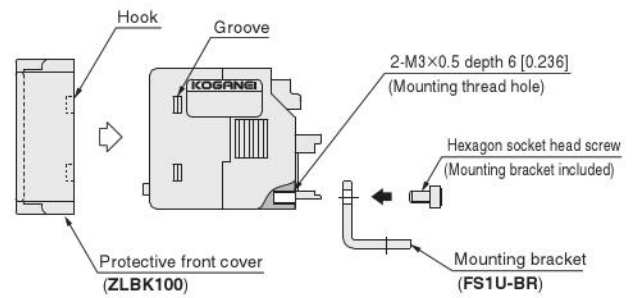

Use the hex socket head screw (M3×0.5, length 5 mm [0.197 in]) to attach the mounting bracket into the mounting hole on the back of the flow rate sensor controller.

Use the tightening torque of 0.5 N·m [0.369 ft·lbf] Attach the protective front cover so the inside tabs enter the slots on the flow rate sensor controller. When removing the cover, hold the cover protrusions.

Specifications

● 1-channel Flow Rate Sensor Controller

Item	Model	FS1U
Power	Power supply voltage	24 VDC ±10%
	Sensor head supply voltage	24 VDC ±10% ^{Note 1}
	Consumption current	50 mA max. (not including supply power to sensor) <ul style="list-style-type: none"> • Display off: 15 mA MAX. (LCD backlight off) • Normal sensing: 25 mA MAX. • E-2 display: 50 mA MAX. (When sensor input overvoltage error generated)
Name	Value display	7-segment LED, 4-digit display (Display colors: green, red)
	Display cycle	Selectable: 250 ms, 500 ms, 1000 ms
	Display accuracy	±1% F.S., ±1 digit (10 L type: ±5% F.S., ±1 digit for 5 L and greater)
	Resolution	FS-R3 selected: 0.01 ℓ/min (ANR) [0.610 in ³ /min] FS-R05 selected: 1 mℓ/min(ANR) [0.061 in ³ /min] FS-10 selected: 0.01 ℓ/min (ANR) [0.610 in ³ /min] However, 0.05 ℓ/min (ANR) [0.002 ft ³ /min] in the case of 5 ℓ/min (ANR) [0.177 ft ³ /min] and greater.
	Operation indicator lamp	Red indicator lit when ON.
Sensor input	Applicable sensor heads	FS-R3, FS-R05, FS-10
	Input voltage	1.0 to 5.0 VDC
	Maximum input voltage	5.3 V MAX.
	Sensor supply voltage	Supply from sensor controller
Switch output	Output points	4 points (NPN open collector) <ul style="list-style-type: none"> • Comparative output: 3 points (OUT1, OUT2, OUT3) • Error output: 1 point
	Load voltage	30 VDC MAX.
	Load current	50 mA MAX.
	Repeatability	±0.1% F.S. (relative to sensor input voltage)
	Internal voltage drop	0.3 V MAX./for load current of 5 mA)
	Response time	2 ms MAX. <ul style="list-style-type: none"> • Selectable delay • Factory default: 2 ms
	Output mode	Window comparator mode 1, Window comparator mode 2 Window comparator mode 3, Window comparator mode 4 Hysteresis mode
Response differential	Selectable (Can be set to two digits or more.) However, 0.05 ℓ/min (ANR) [0.002 ft ³ /min] MIN. when FS-10 is selected. ^{Note 2}	
Analog output (FS1U-S only)	Output voltage	1 to 5 VDC (non-linearity), Output impedance: Approximately 1 KΩ (Flow rate sensor output signal is output as-is.)
Settings ^{Note 3}	Main unit key setting	Refer to pages 1668 to 1669 .
	External communication settings (RS-232C) ^{Note 4}	Refer to pages 1669 to 1671 .
Protective structure	Operating temperature range	-10 to 50°C [-14 to 122°F] (non-condensation, non-freezing)
	Storage temperature range	-20 to 80°C [-4 to 176°F] (non-condensation, non-freezing)
	Noise resistance	EN61000-4-4 EFT/B level power supply: ±1 KV (Level 2) DATA: ±1 KV (Level 3)
	Dielectric strength	500 VAC, 1 minute
	Insulation resistance	100 MΩ or greater at 500 VDC megger
	Vibration resistance	10 to 55 Hz, two hours in each direction (XYZ)
	Shock resistance	490 m/s ² [50 G] (non-repeated)
General	Material	Case: PBT
	Mass	30 g [1.058 oz] (Excluding cable)

Note 1: Relative to control power supply voltage, supply voltage to the sensor head drops 0.5 V MAX.

2: 0.05 ℓ/min (ANR) [0.002 ft³/min]MIN. when FS-10 is selected. When any other value is set, it is rounded up in increments of 0.05 ℓ/min (ANR) [0.002 ft³/min].

3: 5 ℓ/min (ANR) [0.177 ft³/min] or greater when FS-10 is selected causes the threshold value (L1, L2) settings to be in increments of 0.05 ℓ/min (ANR) [0.002 ft³/min]. When any other value is set, it is rounded down in increments of 0.05 ℓ/min (ANR) [0.002 ft³/min].

4: FS1U-S-D (RS-232C specification) only.

5: Unless specifically noted otherwise, measured temperature is room temperature (25 ±5°C [77 ±9°F]).

Specifications

● Flow rate sensor head

Item	Model	FS-R3	FS-R05	FS-10
Measurement target gas		Air or nitrogen, however, the detected fluid must not contain any salt, sulfur, acid, or other corrosive elements. Also, air must be dry. Clean gas that does not include any dust or mist (oil mist).		
Flow rate measurement range		-3 to +3 ℓ/min (ANR) [-0.106 to 0.106 ft ³ /min]	-500 to +500 mℓ/min (ANR) [-30.512 to 30.512 in ³ /min]	0 to +10 ℓ/min (ANR) [0 to 0.353 ft ³ /min]
Response		5 ms or lower (95% response to stepped flow rate change)		
Output signal		1 to 5 VDC (non-linear characteristics); allowable load resistance: 10 kΩ or greater		
Operating temperature range		0 to 50°C [32 to 122°F] (Both ambient temperature and measured fluid temperature)		
Storage temperature range		-10 to 60°C [-14 to 140°F]		
Operating/storage humidity range		10 to 80%RH (non-condensation)		
Operating pressure range		-100 to +200 kPa [-29.5 to 59.1 inHg] (However, the guaranteed pressure characteristics range is -70 to +200 kPa [-20.678 to 59.1 inHg])		
Pressure resistant		300 kPa [88.6 inHg]		
Output voltage accuracy		±5% FS MAX.	±5% FS MAX.	±5% FS MAX.
Standard flow rate characteristics		0.0 ℓ/min [0.000 ft ³ /min]: 3.00 ±0.15 V	0.0 ℓ/min [0.000 ft ³ /min]: 3.00 ±0.20 V	0.0 ℓ/min [0.000 ft ³ /min]: 1.00 ±0.20 V
		0.5 ℓ/min [0.018 ft ³ /min]: 3.88 ±0.15 V	0.1 ℓ/min [0.004 ft ³ /min]: 3.77 ±0.20 V	3.0 ℓ/min [0.106 ft ³ /min]: 3.89 ±0.15 V
		1.5 ℓ/min [0.053 ft ³ /min]: 4.49 ±0.15 V	0.3 ℓ/min [0.011 ft ³ /min]: 4.53 ±0.20 V	5.0 ℓ/min [0.177 ft ³ /min]: 4.46 ±0.15 V
		3.0 ℓ/min [0.106 ft ³ /min]: 5.00 ±0.20 V	0.5 ℓ/min [0.018 ft ³ /min]: 5.00 ±0.20 V	10.0 ℓ/min [0.353 ft ³ /min]: 5.00 ±0.20 V
Reproducibility		±3.5% FS MAX.	±2% FS MAX.	±6% FS MAX.
Output characteristics		Same conditions apply to temperature and pressure during measurement.		
		±0.01% FS/kPa	±0.01% FS/kPa	±0.01% FS/kPa (0 to +200 kPa)
Temperature characteristics		In -70 to +200 kPa [-20.678 to 59.1 psi] pressure range		
		±0.03% FS/kPa (-70 to 0 kPa)		
Power supply voltage		0.0 ℓ/min [0.000 ft ³ /min]: ±0.1% FS/°C	0.0 ℓ/min [0.000 ft ³ /min]: ±0.1% FS/°C	0.0 ℓ/min [0.000 ft ³ /min]: ±0.1% FS/°C
		1.5 ℓ/min [0.053 ft ³ /min]: ±0.15% FS/°C	0.3 ℓ/min [0.011 ft ³ /min]: ±0.15% FS/°C	5.0 ℓ/min [0.177 ft ³ /min]: ±0.2% FS/°C
Power supply voltage		24 VDC (Supply from sensor controller)		
Allowable voltage fluctuation range		In the 21.6 to 26.4 VDC range, ±2% FS or lower relative to an output value during 24 VDC ^{Note 2}		
Output stabilization time		Time required until output is within ±5% FS of maximum voltage attained (flow rate): Instantaneous		
		Time required until output is within ±1% FS of maximum voltage attained (flow rate): Within 10 seconds		
Consumption current		12 mA MAX.		
Dielectric strength		Between all external connector terminals and the body: 500 VAC for 1 minute, or 600 VAC for one second		
Insulation resistance		All external connector terminals—Between bodies: 50 MΩ (500 VDC megger)		
Connection type		M5 female thread (brass insertion); tightening torque: 2.5 N·m [22.128 in·lbf] or less		
Material		Gas contact part: PPS resin (main flow path), ceramic (substrate) brass (contacts)		
		Cover: PC resin (polycarbonate)		
Mounting direction		Excluding directions where the cover is facing downwards.		
Mounting criteria		When using this device's mounting holes, use M3 screws, and tighten to a torque of 0.6 N·m [5.311 in·lbf] or less. A filter that captures dust and mist with a particle size of 10 μm or greater can be installed on the upstream side of this device.		
Straight piping length		Not required for both upstream and downstream.		
Vibration resistance		10 to 55 Hz; total amplitude: 1.5 mm [0.059 in]; each direction (XYZ) for two hours		
Mass		9 g [0.317 oz]		
Electric connection (Special connector)		Cable with special connector		
		Flow rate sensor head side: J.S.T. Mfg. Co., Ltd. SM03B-SRSS-G-TB Other side: J.S.T. SHR-03V-S-B (housing), SSH-003GA-P0.2 (contact)		

Note 1: The % FS shown here assumes output voltage 4 V (1 to 5 V) full scale.

Note 2: In the vicinity of the measurement range upper limit flow rate, output fluctuation of ±1% FS (drift volume 500 seconds from flow rate stabilization) at most is generated following flow rate stabilization.

Flow rate sensor Head Flow Rate and Output Characteristics Graphs

● FS-R05

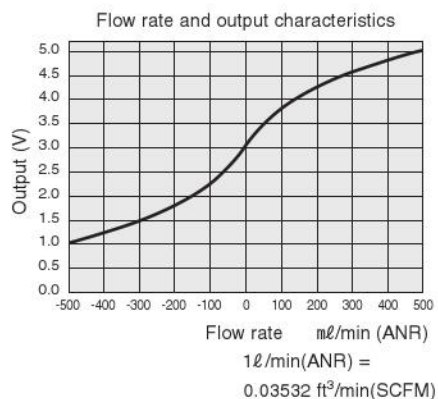

● FS-R3

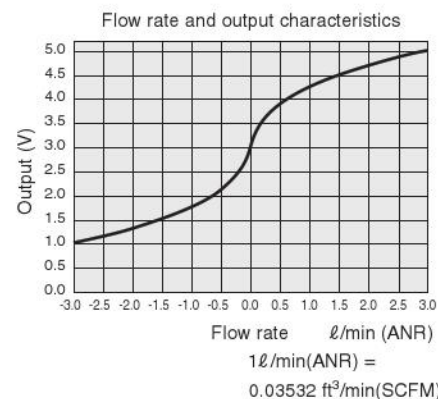

● FS-10

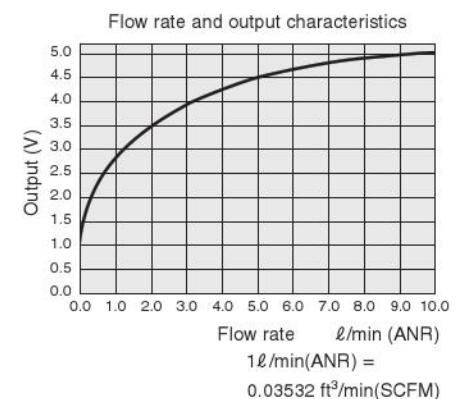

Internal Circuit Diagrams and Wiring Specifications (External Wiring Example)

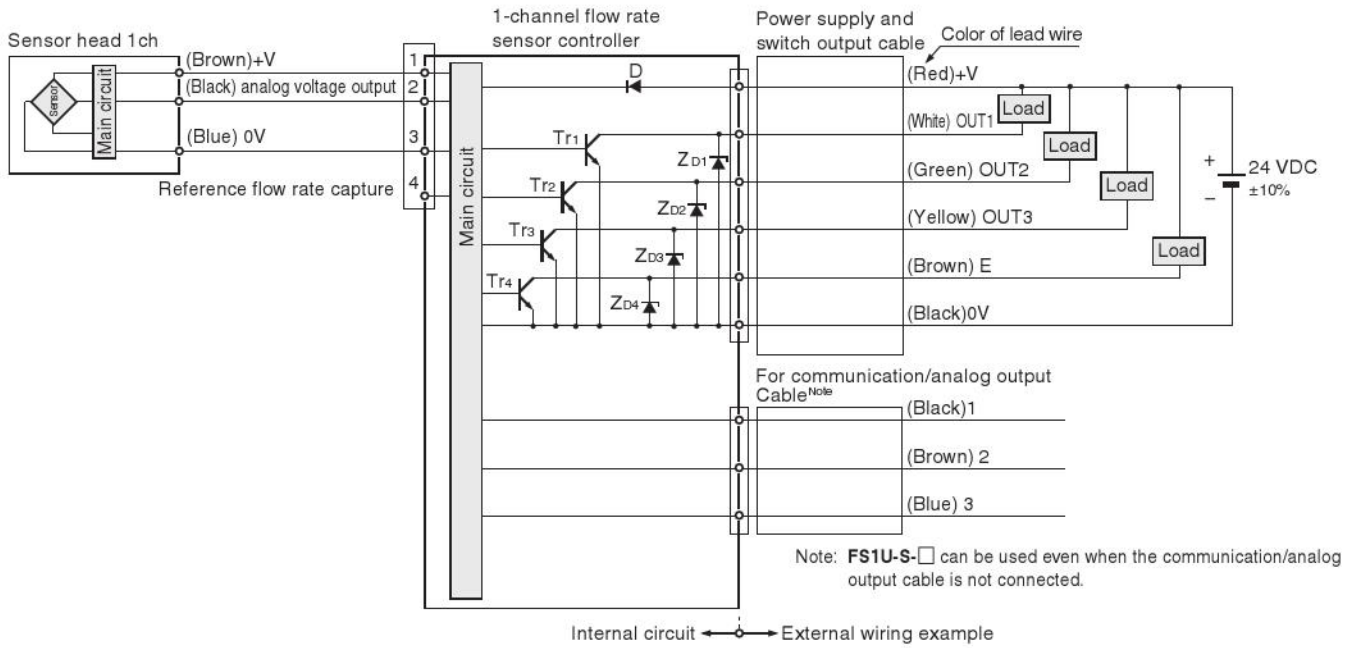

● Communication/analog output cable wiring specifications

Number on connector	Connection wire color	Signal name (FS1U-S)	Signal name (FS1U-S-D)
1	Black	Analog output	TXD
2	Brown	Zero reset input	RXD
3	Blue	0V	0V

Note: If you use an extended cable, be aware that voltage drops due to its resistance.

Symbol D:	Power supply reverse connection protection diode
ZD1 to ZD4:	Zener diode for absorbing surge voltage
Tr1 to Tr4:	NPN output transistor



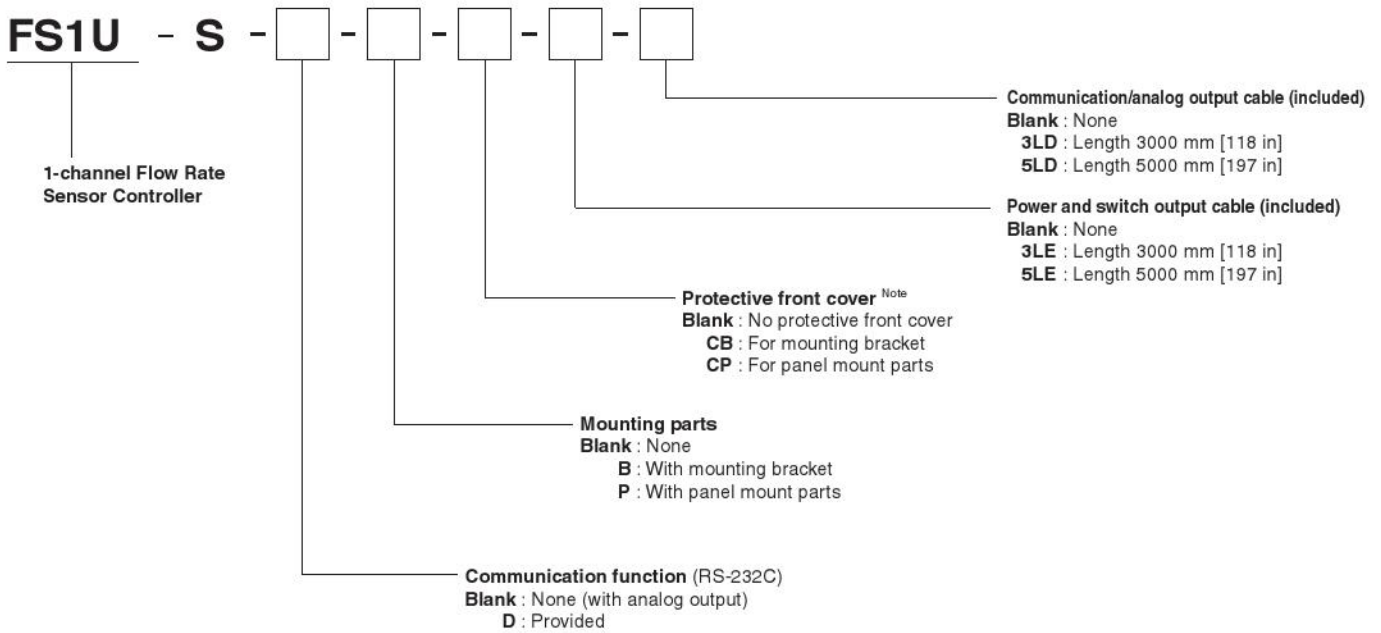





Order codes

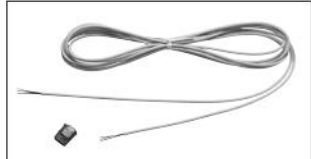

Note Flow rate sensor head **FS-** is required when using a separate type flow rate sensor controller. Order it separately.

Note: With mounting bracket type **-B** cannot be used in combination with **-CP**.
 With part for panel mount type **-P** cannot be used in combination with **-CB**.

Additional parts (available separately)

<p>Flow rate sensor head</p> <p>● FS- <input type="checkbox"/></p> <p>Flow rate range</p> <p>Flow rate sensor head</p> <p>R05: 0 to 500 ℓ/min (ANR) [-30.512 to 30.512 in³/min] R3: 0 to 3 ℓ/min (ANR) [-0.106 to 0.106 ft³/min] 10: 0 to 10 ℓ/min (ANR) [0 to 0.353 ft³/min]</p> 	<p>Sensor head connecting cable</p> <p>● FS1UK- <input type="checkbox"/></p> <p>Cable length</p> <p>3L: 3000 mm [118 in] 5L: 5000 mm [197 in]</p> 	<p>Power supply, switch and communication cable</p> <p>● FS1UEW- <input type="checkbox"/></p> <p>Cable length</p> <p>3L: 3000 mm [118 in] 5L: 5000 mm [197 in]</p> 	<p>Communication/analog output cable</p> <p>● FS1UDW- <input type="checkbox"/></p> <p>Cable length</p> <p>3L: 3000 mm [118 in] 5L: 5000 mm [197 in]</p> 
<p>Mounting bracket</p> <p>● FS1U-BR</p> 	<p>Protection front cover</p> <p>● ZLBK100</p> 	<p>Panel mounting parts</p> <p>● FS1U-PM</p> 	<p>Protection front cover</p> <p>● FS1U-BK</p> 
<p>Mini clamp wire mount plug (For communication/analog output cable)</p> <p>● FS1U-3M</p> 	<p>Mini clamp wire mount plug (For sensor head cable)</p> <p>● FS1U-4M</p> 		

Dimensions mm [in]

● **FS1U-S-□ 1-channel Flow Rate Sensor Controller**

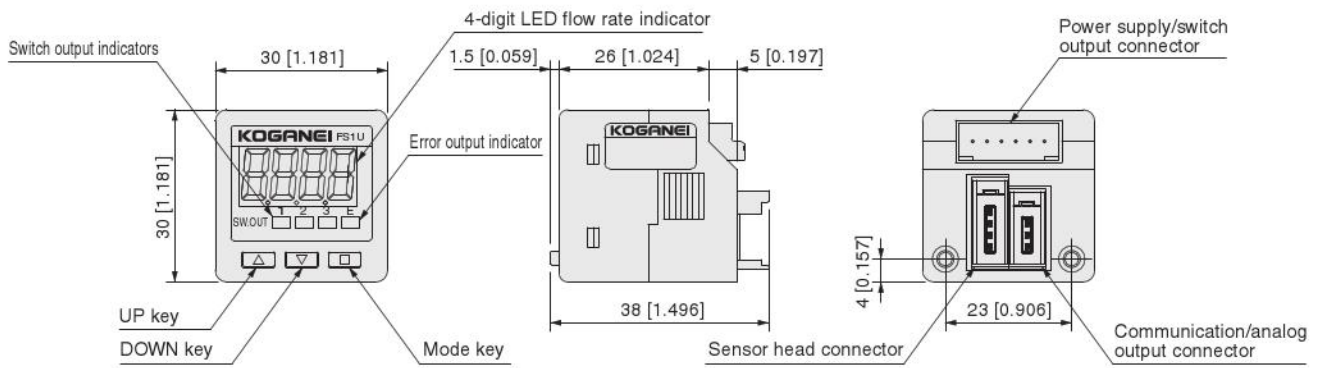

● **FS-□ Flow rate sensor head**

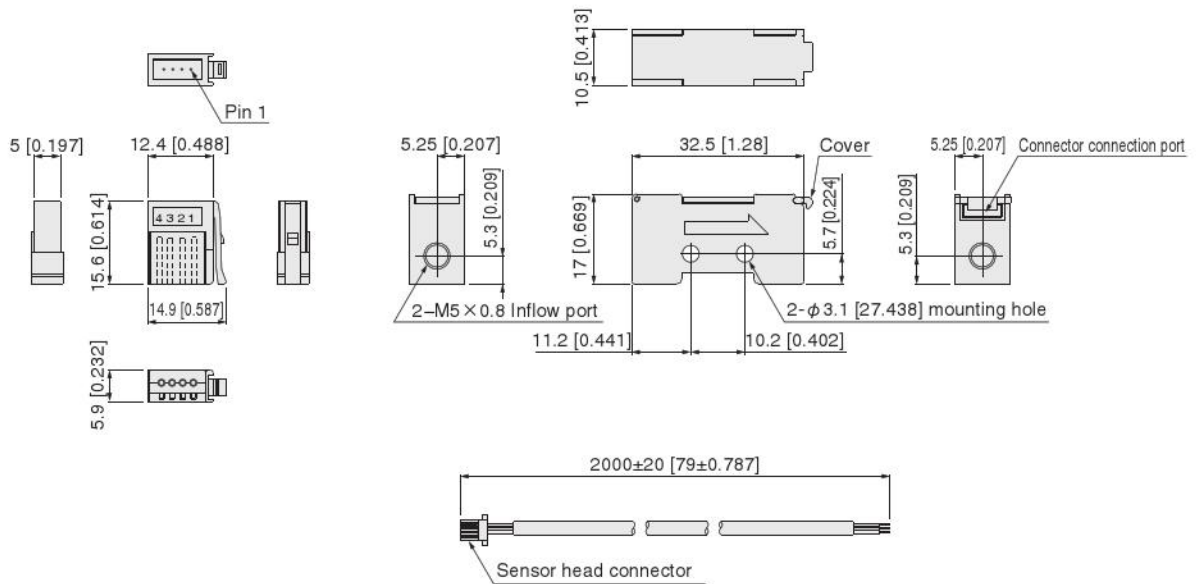

● **FS1UK-□ Sensor head connecting cable**

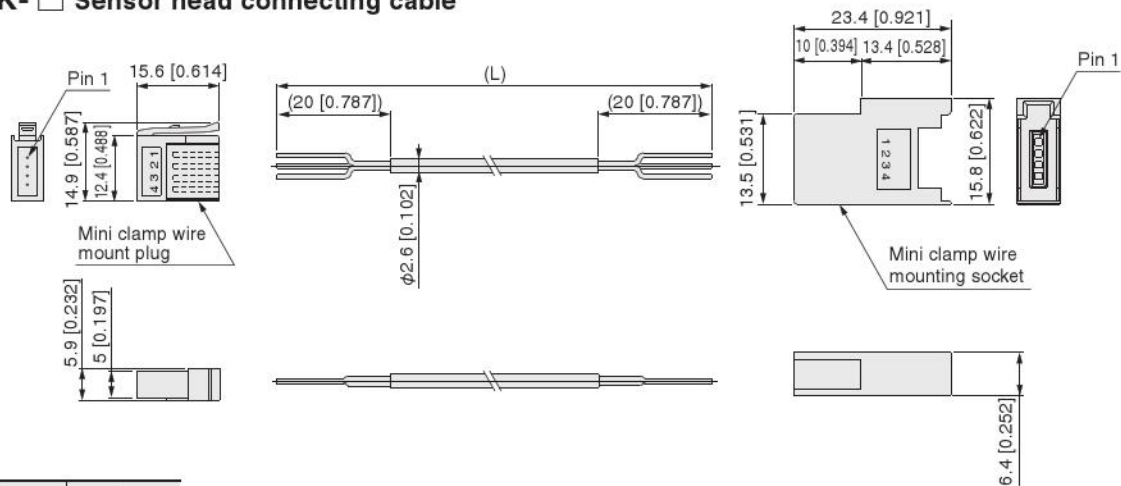

Model	L
FS1UK-3L	3000 [118]
FS1UK-5L	5000 [197]

Dimensions mm [in]

● **FS1UEW-** □ Power supply/switch output cable

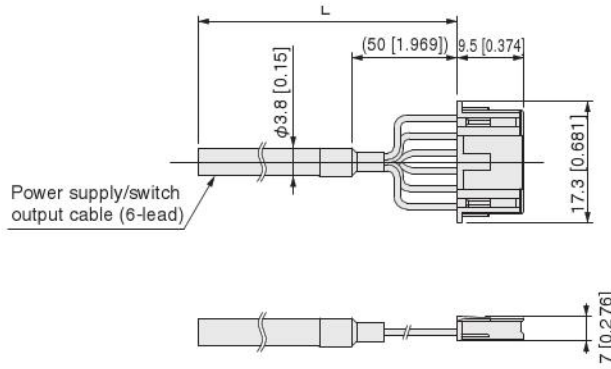

Model	L
FS1UEW-3L	3000 [118]
FS1UEW-5L	5000 [197]

No.	Item	Color
1	+24 V	Red
2	GND	Black
3	SW 1	White
4	SW 2	Green
5	SW 3	Yellow
6	E	Brown

● **FS1UDW-** □ Communication/analog output cable

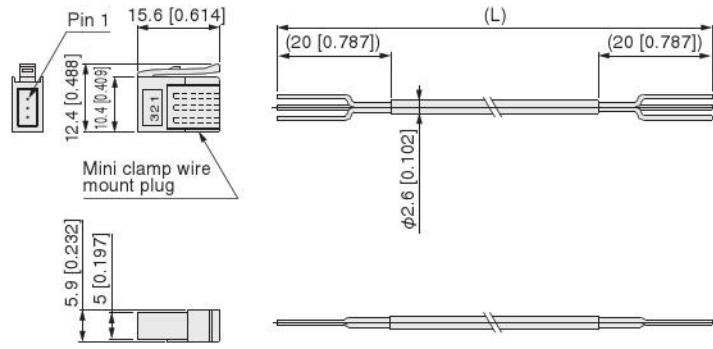

Model	L
FS1UDW-3L	3000 [118]
FS1UDW-5L	5000 [197]

● **FS1U-BR** Mounting bracket

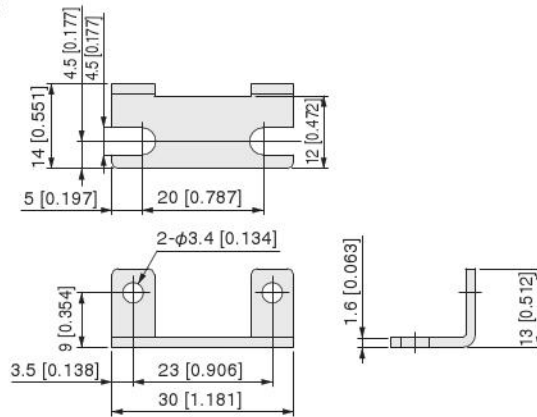

Hexagon socket head screw
M3×0.5, length 5 [0.197], two included

● **FS1U-PM** Panel mounting parts

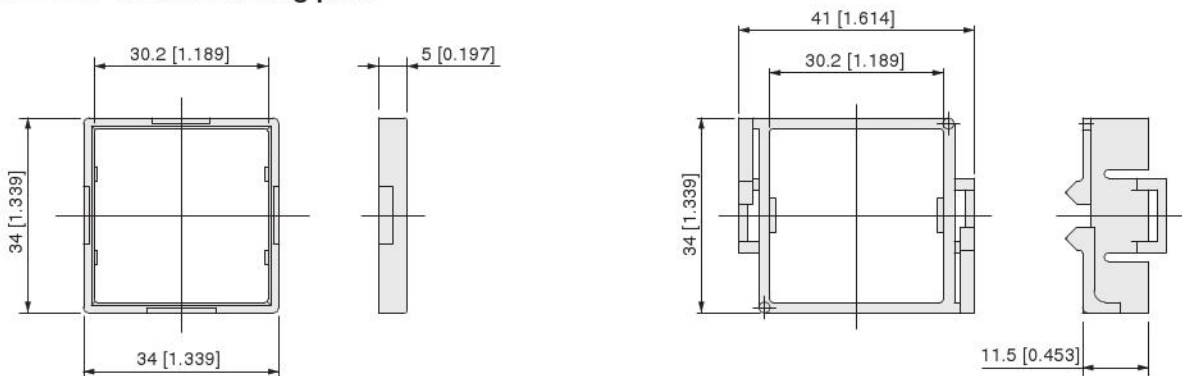

● ZLBK100 Protective front cover for mounting bracket

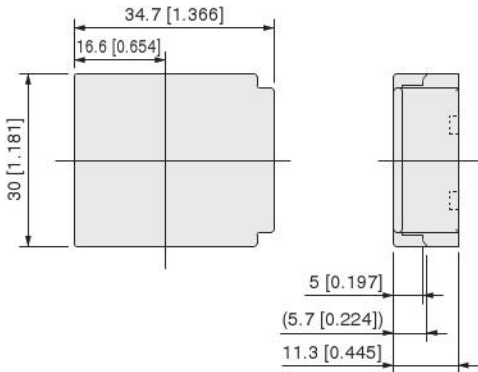

● FS1U-BK Protective front cover for panel mount parts

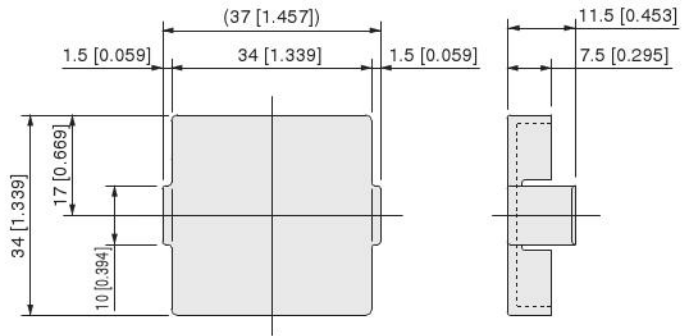

● FS1U-3M Mini clamp wire mount plug
(For communication/analog output cable)

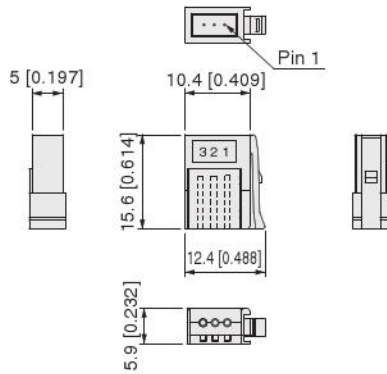

● FS1U-4M Mini clamp wire mount plug
(For sensor head cable)

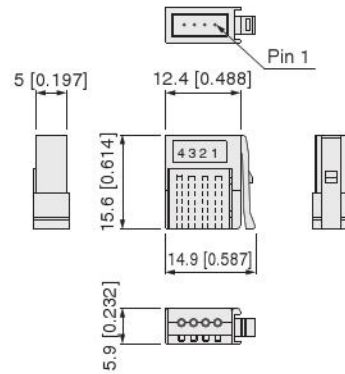

● Dimensions of cut panel to mount the sensor controller (for panel mount)

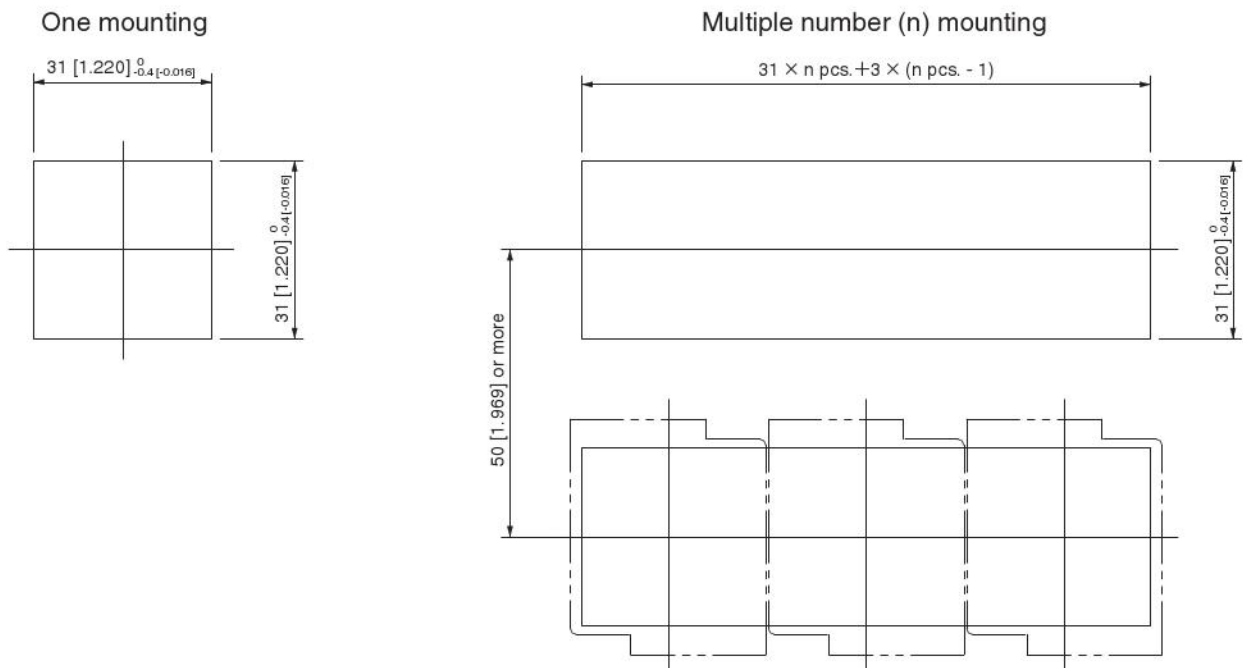

Note: Use a panel thickness of 1 to 6 mm [0.039 to 0.236 in].



Setting guidelines

CAUTION

1. Incorrect wiring to the sensor head, power/switch output, and communication/analog output cables creates the risk of damage to both the controller and sensor head. Confirm that wiring is correct before turning on power.
2. The conditions that were configured are saved as a record written to flash memory. Note that flash memory has a limited life, and the number of guaranteed writes is 10,000.
3. With window comparator mode 2, repeated reference flow rate import can cause the guaranteed number of flash memory writes to be exceeded within a short period. When this happens, use window comparator mode 3.
4. Explanation text uses the following symbols: CO1 for window comparator 1, CO2 for window comparator 2, CO3 for window comparator 3, CO4 for window comparator 4, HYS for hysteresis mode.

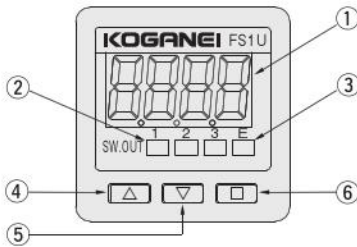
Nomenclature and functions



No.	Name	Description
①	LED display	Detected flow rate values, setting details, error indicators
②	Switch output indicator	Lights when switch output is ON (Channels 1, 2, 3)
③	Error output indicator	Lights when error output is ON.
④	UP key ()	Use to increase a setting value, etc.
⑤	DOWN key ()	Use to decrease a setting value, etc.
⑥	Mode key ()	Use when configuring settings.

Preparation for settings

- Connect the connector to the sensor head.
Refer to "Communication/analog output cable connector connection instructions" on page 1657.
- Connect the sensor head and power/switch output cable to the controller.
Refer to "Attaching and removing cables for sensor head, power/switch output, and for communication/analog output" on page 1658.
- Connect the communication/analog output cable as required.
Refer to "Attaching and removing cables for sensor head, power/switch output, and for communication/analog output" on page 1658.

Setting procedure

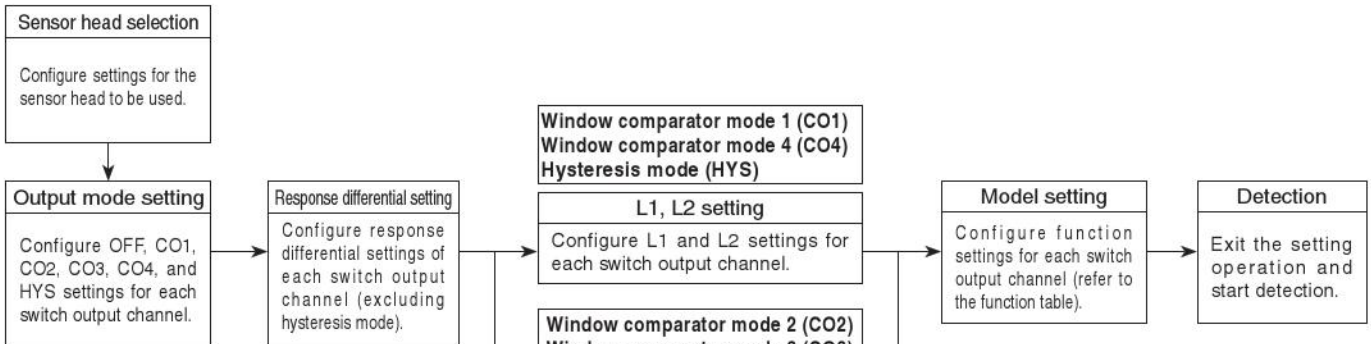

Factory default settings (reset mode default settings)

Threshold voltage L1 (ΔL)	: All channels 2.00 ℓ /min [0.071 ft ³ /min]
Threshold voltage L2	: All channels 1.00 ℓ /min [0.035 ft ³ /min]
Response differential	: All channels 0.02 ℓ /min [0.001 ft ³ /min]
Switch output mode:	1 channel 1 (Window comparator mode 1) 2 channel 0 (Channel disabled) 3 channel 0 (Channel disabled)
Switch output inversion	: All channels 0 (non inversion)
Switch response time	: 1 (2 ms MAX.)
Sensor head type	: 1 (-3.00 to 3.00: ± 3 R type)
LCD backlight	: 1 (Green when switch output is OFF,—Red when switch output is ON)
LCD refresh cycle	: 1 (250 ms)

CAUTION

- Always turn off power before connecting to the connector.
- Connecting the sensor head while power is on will cause an overvoltage error (E-2 displayed). If this happens, hold down the mode key () for at least one second to clear the error.

Settings

● Importing reference flow rates in window comparator modes 2 and 3

Method using main unit key operations	For operational procedures, refer to page 1668.
Method using RS-232C	For RS-232C commands, refer to page 1670.
Method using general purpose I/O input	Refer to the diagram below.

● Importing reference flow rate using general purpose I/O input

This operation imports reference flow rates for the switch output 1 channel.

Make PIN (connector pin 4 for the sensor head) L level (less than 0.5 V, greater than 10 ms).

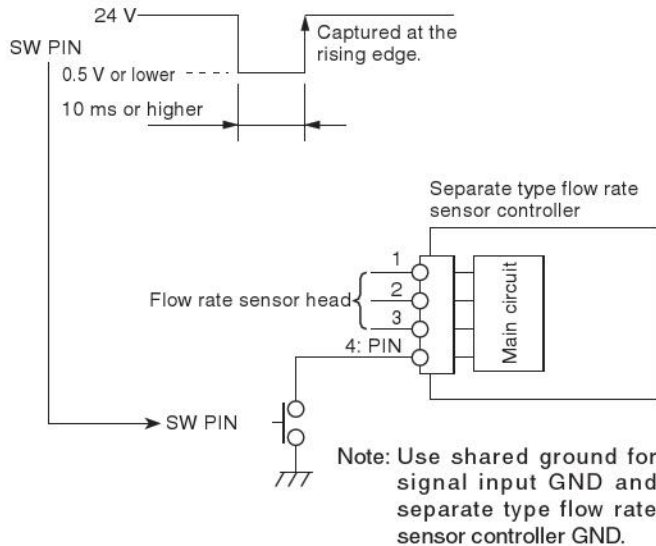

If you are not importing reference flow rates using the general purpose I/O input, do not connect anything to PIN. PIN is pulled up by 24 V.

● Zero point correction procedure

Method using main unit key operations	For operational procedures, refer to page 1668.
Method using RS-232C	For RS-232C commands, refer to page 1671.
Method using general purpose I/O input	Refer to the diagram below.

● Zero point correction using general purpose I/O input

Make ZERO (connector pin 2 for analog) L level (less than 0.5 V, greater than 10 ms).

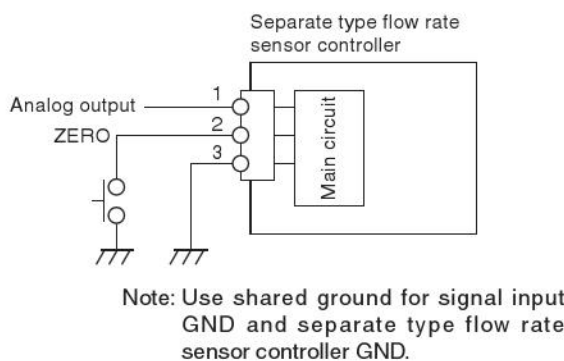

If you are not performing zero correction using the general purpose I/O input, do not connect anything to PIN. PIN is pulled up by 24 V.

Note: Turning off power cancels zero point correction.

● Function list (For details about operations, refer to each operational procedure.)

Function	Unit button operation	Communication commands (-D only)
Flow rate display	○ (when in sensing mode)	@A
Switch output status indicator	○ (when in sensing mode)	@SW
L1(Δ L)/L2 point settings	○	@PRE
L1(Δ L)/L2 point confirmation	×	@C
Response differential setting	○	@HYS
Response differential confirmation	×	@H
Reference flow rate import	○	@P
Reference flow rate - Δ L/OFF confirmation	×	@E (CO ₂ , CO ₃ only)
Switch output mode selection	○	@MODE
Switch output mode confirmation	×	@MD
Switch output response time setting	○	@DLY
Switch output response time setting confirmation	×	@SD
Sensor head type setting	○	@TYPE
Sensor head type setting confirmation	×	@TP
Switch output inversion setting	○	@INV
Switch output inversion setting confirmation	×	@I
LCD backlight color setting	○	@BLS
LCD backlight color setting confirmation	×	@BL
LCD display cycle setting	○	@LCT
LCD display cycle setting confirmation	×	@LT
Peak hold	○	@PHL
Bottom hold	○	@BHL
Zero point correction	○	@B

Setting guidelines

Sensing mode

- Turning on power (power supply voltage 24 VDC) automatically enters the sensing mode.
- When **OFF** appears on the display, it means the sensor head is not connected or burned out.
- In case of burn out, turn off power and then replace the sensor head.

Sensor head selection

Use the procedure below to configure settings for the sensor head to be used.

Procedure	Main unit operation	7-segment display	Remark
1	[]	SEF 1	Hold down [] at least one second
2	[]	SEF	
3	[Δ] [▽] (Press at the same time.)	SE 1	Use [Δ] or [▽] to select the sensor head type.
4	[]		Applies sensor head type.

Note: SE2 and SE4 cannot be used.

Sensor head selection

SE1: -3.00 to 3.00: ±3 R type
 SE2: Not usable
 SE3: -500 to 500: ±500 mR type
 SE4: Not usable
 SE5: 0.00 to 10.00: 10 R type

Output mode selection

Use the procedure below to specify the output mode for each switch output channel.

Procedure	Main unit operation	7-segment display	Remark
1	[]	SEF 1	Hold down [] at least one second
2	[]	SEF	
3	[Δ] [▽] (Press at the same time.)	CH 1	Use [Δ] or [▽] to select channel.
4	[]	CO 1	Use [Δ] or [▽] to select output mode.
5	[]		Applies output mode.

Output mode selection

OFF: Channel disabled
 CO1: Window comparator mode 1
 CO2: Window comparator mode 2
 CO3: Window comparator mode 3
 CO4: Window comparator mode 4
 HYS: Hysteresis mode

Response differential setting

Use the procedure below to specify the response differential for each switch output channel.

Procedure	Main unit operation	7-segment display	Remark
1	[]	SEF 1	Hold down [] at least one second
2	[Δ]	SEF 2	
3	[]	SEF	
4	[Δ] [▽] (Press at the same time.)	HFS 1	Use [Δ] or [▽] to select channel.
5	[]	002	Use [Δ] or [▽] to set response differential.
6	[]		Applies response differential.

[Response differential setting]

HYS1: 1ch
 HYS2: 2ch
 HYS3: 3ch
 • Response differential to prevent chattering is a setting that is at least two digits.

Threshold value setting (L1 (Δ LYL2 setting))

Use the procedure below to configure threshold value settings for each switch output channel.

Procedure	Main unit operation	7-segment display	Remark
1	[]	SEF 1	Hold down [] at least one second
2	[]	SEF	
3	[]	11	Use [Δ] or [▽] to select channel.
4	[]	***	Use [Δ] or [▽] to set the threshold value.
5	[]		Applies threshold value setting.

Threshold value setting

11: 1ch_L1/ΔL
 12: 1ch_L2
 21: 2ch_L1/ΔL
 22: 2ch_L2
 31: 3ch_L1/ΔL
 32: 3ch_L2

Reference flow rate import (Window comparator mode 2, 3)

Use the procedure below to import reference flow rates for each switch output channel when window comparator mode 2 or 3 is used.

Procedure	Main unit operation	7-segment display	Remark
1	[]	SEF 1	Hold down [] at least one second
2	[]	SEF	
3	[Δ] [▽] (Press at the same time.)	REF 1	Use [Δ] or [▽] to select channel.
4	[]		Reference flow rate import

Reference flow rate import

REF1: 1ch
 REF2: 2ch
 REF3: 3ch

Switch output inversion setting

You can use the procedure below to invert switch output for each switch output channel.

Procedure	Main unit operation	7-segment display	Remark
1	[]	SEF 1	Hold down [] at least one second
2	[Δ]	SEF 2	
3	[Δ]	SEF 3	
4	[]	SEF	
5	[Δ] [▽] (Press at the same time.)	CH 1	Use [Δ] or [▽] to select channel.
6	[]	S-0	Use [Δ] or [▽] to set.
7	[]		Applies switch output inversion setting.

Switch output inversion setting

S-0: Non-inversion (A contact)
 S-1: Inversion (B contact)

Zero point correction (zero reset)

Use the procedure below to perform zero point correction.

Procedure	Main unit operation	7-segment display	Remark
1	[]	SEF 1	Hold down [] at least one second
2	[Δ]	SEF 2	
3	[Δ]	SEF 3	
4	[]	SEF	
5	[Δ] [▽] (Press at the same time.)		Corrects zero point.

Note: Turning off power cancels zero point correction.

Switch output response time setting

Use the procedure below to set the switch output response time.

Procedure	Main unit operation	7-segment display	Remark
1	[]	SEF 1	Hold down [] at least one second
2	[Δ]	SEF 2	
3	[Δ]	SEF 3	
4	[]	SEF	
5	[▽] [] (Press at the same time.)	Sd- 1	Use [Δ] or [▽] to set.
6	[]		Applies switch output response time setting.

Switch output response time setting

Sd-1: 2 ms MAX.
 Sd-2: 20 ms MAX.
 Sd-3: 100 ms MAX.
 Sd-4: 1000 ms MAX.

Note: All switch output channels are changed. Setting of each individual channel is not supported.

LCD display cycle setting

Use the procedure below to configure the LCD display cycle setting.

Procedure	Main unit operation	7-segment display	Remark
1	[]	SEF 1	Hold down [] at least one second
2	[Δ]	SEF 2	
3	[Δ]	SEF 3	
4	[Δ]	SEF 4	
5	[]	SEF	
6	[Δ] [▽] (Press at the same time.)	dT- 1	Use [Δ] or [▽] to set.
7	[]		Applies LCD display cycle setting.

LCD display cycle setting

dT-1: 250 ms
 dT-2: 500 ms
 dT-3: 1000 ms

Backlight color setting

Use the procedure below to configure backlight color settings.

Procedure	Main unit operation	7-segment display	Remark
1	[]	SEF 1	Hold down [] at least one second
2	[Δ]	SEF 2	
3	[]	SEF	
4	[▽] [] (Press at the same time.)	bL- 1	Use [Δ] or [▽] to set.
5	[]		Applies backlight color setting.

Setting the backlight color

bL-0: Backlight OFF
 bL-1: Green when switch output is OFF, red when switch output is ON.
 bL-2: Red when switch output is OFF, green when switch output is ON.
 bL-3: Always green
 bL-4: Always red
 • Linkage with switch output is linked with switch output channel 1.

Setting guidelines

Peak hold, Bottom hold

You can use the procedure below specify peak hold or bottom hold for the flow rate display.

Procedure	Peak hold	7-segment display	Bottom hold	7-segment display	Remarks
1	<input type="checkbox"/>	SEF 1	<input type="checkbox"/>	SEF 1	Hold down <input type="checkbox"/> at least one second
2	<input type="checkbox"/>	SEF 2	<input type="checkbox"/>	SEF 2	
3	<input type="checkbox"/>	SEF 3	<input type="checkbox"/>	SEF 3	
4	<input type="checkbox"/>	SEF 4	<input type="checkbox"/>	SEF 4	
5	<input type="checkbox"/>	SEF	<input type="checkbox"/>	SEF	
6	<input type="checkbox"/> (Press at the same time.)	PHL	<input type="checkbox"/> (Press at the same time.)	bHL	Hold start
7	<input type="checkbox"/> (Press at the same time.)		<input type="checkbox"/> (Press at the same time.)		Hold cancel

Note: Turning off power cancels peak hold or bottom hold.

Peak hold and bottom hold cannot be performed at the same time.

Error Indications

Name	Error description	Error clear
off	The selected channel's sensor head is not connected or burned out.	In case of burn out, turn off power and then replace the sensor head.
E-1	In window comparator mode 2 and 3, the threshold value setting is outside the measuring range.	After eliminating the cause of the error, hold down the mode key for at least one second.
E-2	Overvoltage applied to sensor input.	
E-3 <input type="checkbox"/> (n = applicable channel)	Overcurrent flowing to switch output.	

Communication

Communication with a computer

- Hardware and system requirements
Computer: PC-98 Series (excluding PC-98LT) or compatible
DOS/V computer
OS: Windows 95 or higher
- Software and system requirements
Use HyperTerminal, Tera Term, or another Windows terminal emulator.

Communication parameters

Baud rate	9600 [baud]
Stop bit length	1 [bit]
Parity specification	Odd [ODD]
Parity check	Available
Data bit length	8 [bits]
Communication method	Full-duplex
Return key transmission process	CR code, LF code

Communication cable specifications and connection

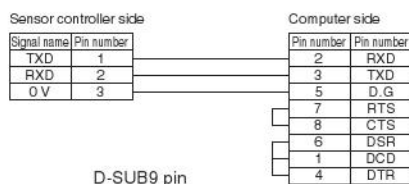
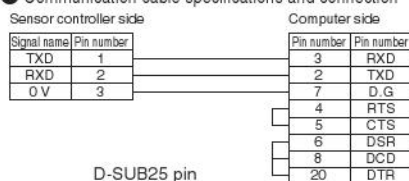

Communication commands (-D only) Command list

Note: " " is a space (0x20), [c/r] is a carriage return (0x0D), and [l/f] is a linefeed (0x0A). Figures in parentheses are ASCII codes.

- **@A**
Function: Recalls the current flow rate value.
Example transmission: @A[c/r][l/f]
Example response: 1.50[c/r][l/f]
Example response: [c/r][l/f] ← When sensor head is not connected
Example response: NG[c/r][l/f]
21: illegal type[c/r][l/f]

- **@SW**
Function: Recalls output status of the current switch output.
Example transmission: @SW[c/r][l/f]
Example response: 1010[c/r][l/f]
Example response: NG[c/r][l/f]
21: illegal type[c/r][l/f]

1 0 1 0
↑ ↑ ↑ ↑
1 2 3 E
ch ch ch

0: Switch output OFF
1: Switch output ON

@PRE

Function: Sets the ON/OFF point of each switch output channel.

Example transmission: @PRE11 1.50[c/r][l/f]

Example response: OK[c/r][l/f]

Example response: NG[c/r][l/f]
21: illegal type[c/r][l/f]

@PRE11: Channel 1, L1/ΔL setting
@PRE12: Channel 1, L2 setting
@PRE21: Channel 2, L1/ΔL setting
@PRE22: Channel 2, L2 setting
@PRE31: Channel 3, L1/ΔL setting
@PRE32: Channel 3, L2 setting

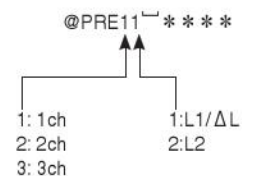

@C

Function: Displays the L1 (ΔL) and L2 of each switch output channel.

Example transmission: @C1[c/r][l/f]

Example response: 1.00[c/r][l/f] ← L1(ΔL)

0.50[c/r][l/f] ← L2

[c/r][l/f]

Example response: NG[c/r][l/f]
21: illegal type[c/r][l/f]

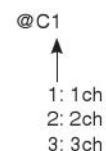

Communication

@ HYS

Function: Sets the hysteresis width for each switch output channel.

Transmission example: @HYS11 $_$ 2.50[c/r][l/f]

Example response: OK[c/r][l/f]

Example response: NG[c/r][l/f]

21: illegal type[c/r][l/f]

@HYS11: Channel 1, hysteresis width setting

@HYS21: Channel 2, hysteresis width setting

@HYS31: Channel 3, hysteresis width setting

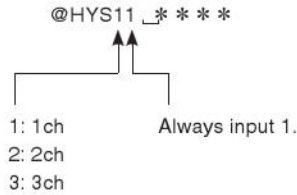

@ H

Function: Displays the hysteresis width for each switch output channel.

Example transmission: @H1[c/r][l/f]

Example response: $_$ 0.05[c/r][l/f]

Example response: NG[c/r][l/f]

21: illegal type[c/r][l/f]

@H1

- 1: 1ch
2: 2ch
3: 3ch

@ P

Function: Import reference flow rates when window comparator modes 2, 3 are selected for the output mode of each switch output channel.

Example transmission: @P1[c/r][l/f]

Example response: OK[c/r][l/f]

Example response: NG[c/r][l/f]

21: illegal type[c/r][l/f]

@P1: Channel 1, reference flow rate import

@P2: Channel 2, reference flow rate import

@P3: Channel 3, reference flow rate import

@ E

Function: Displays the L1 = [reference flow rate] - Δ L and L2 of each switch output channel.

Example transmission: @E1[c/r][l/f]

Example response: $_$ 1.00[c/r][l/f] $_$ L1 = Reference flow rate - Δ L
 $_$ 0.50[c/r][l/f] $_$ L2
[c/r][l/f]

Example response: NG[c/r][l/f]

21: illegal type[c/r][l/f]

@E1

- 1: 1ch
2: 2ch
3: 3ch

@ MODE

Function: Sets the output mode of each switch output channel.

Example transmission: @MODE1 $_$ 1[c/r][l/f]

Example response: OK[c/r][l/f]

Example response: NG[c/r][l/f]

21: illegal type[c/r][l/f]

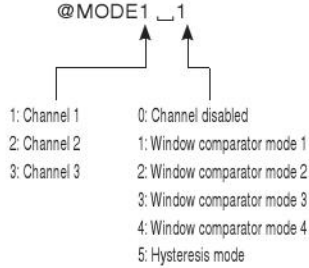

@ MD

Function: Displays the output mode of each switch output channel.

Example transmission: @MD[c/r][l/f]

Example response: 105[c/r][l/f]

Example response: NG[c/r][l/f]

21: illegal type[c/r][l/f]

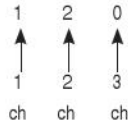

- 0: Channel disabled
1: Window comparator mode 1
2: Window comparator mode 2
3: Window comparator mode 3
4: Window comparator mode 4
5: Hysteresis mode

@ DLY

Function: Sets the switch output response time.

Example transmission: @DLY1[c/r][l/f]

Example response: OK[c/r][l/f]

Example response: NG[c/r][l/f]

21: illegal type[c/r][l/f]

@DLY 1: 2 ms MAX.

@DLY 2: 20 ms MAX.

@DLY 3: 100 ms MAX.

@DLY 4: 1000 ms MAX.

Note: All switch output channels are changed. Setting of each individual channel is not supported.

@ SD

Function: Displays the switch output response time.

Example transmission: @SD[c/r][l/f]

Example response: 1[c/r][l/f]

Example response: NG[c/r][l/f]

21: illegal type[c/r][l/f]

1: 2 ms MAX.

2: 20 ms MAX.

3: 100 ms MAX.

4: 1000 ms MAX.

@ TYPE

Function: Sets the sensor head type.

Example transmission: @TYPE1[c/r][l/f]

Example response: OK[c/r][l/f]

Example response: NG[c/r][l/f]

21: illegal type[c/r][l/f]

@TYPE 1: -3.00 to 3.00: \pm 3 ℓ type

@TYPE 2: Not usable

@TYPE 3: -500 to 500: \pm 500 m ℓ type

@TYPE 4: Not usable

@TYPE 5: 0.00 to 10.00: 10 ℓ type

@ TP

Function: Displays the sensor head type.

Example transmission: @TP1[c/r][l/f]

Example response: 1[c/r][l/f]

Example response: NG[c/r][l/f]

21: illegal type[c/r][l/f]

1: -3.00 to 3.00: \pm 3 ℓ type

2: Not usable

3: -500 to 500: \pm 500 m ℓ type

4: Not usable

5: 0.00 to 10.00: 10 ℓ type

@ INV

Function: Sets the inversion/non-inversion for each switch output channel.

Example transmission: @INV1 $_$ 0[c/r][l/f]

Example response: OK[c/r][l/f]

Example response: NG[c/r][l/f]

21: illegal type[c/r][l/f]

@INV1 $_$ 0

- 1: 1ch
2: 2ch
3: 3ch
4: E
- 0: Non-inversion
1: Inversion

@ I

Function: Displays the inversion/non-inversion setting for each switch output channel.

Example transmission: @I[c/r][l/f]

Example response: 0101[c/r][l/f]

Example response: NG[c/r][l/f]

21: illegal type[c/r][l/f]

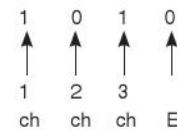

- 0: Switch output non-inversion
1: Switch output inversion

@BLS

Function: Sets the backlight color.

Example transmission: @BLS1[c/r][l/f]

Example response: OK[c/r][l/f]

Example response: NG[c/r][l/f]

21: illegal type[c/r][l/f]

@BLS 0: Backlight OFF0

@BLS 1: Green when switch output is OFF, red when switch output is ON.

@BLS 2: Red when switch output is OFF, green when switch output is ON.

@BLS 3: Always green

@BLS 4: Always red

@BL

Function: Displays the backlight color setting.

Example transmission: @BL[c/r][l/f]

Example response: 1[c/r][l/f]

Example response: NG[c/r][l/f]

21: illegal type[c/r][l/f]

0: Backlight OFF

1: Green when switch output OFF, red when switch output is ON

2: Red when switch output is OFF, green when switch output is ON

3: Always green

4: Always red

@LCT

Function: Sets the LCD display cycle.

Example transmission: @LCT1[c/r][l/f]

Example response: OK[c/r][l/f]

Example response: NG[c/r][l/f]

21: illegal type[c/r][l/f]

@LCT 1: 250 ms

@LCT 2: 500 ms

@LCT 3: 1000 ms

@LT

Function: Shows the LCD display cycle setting.

Example transmission: @LT[c/r][l/f]

Example response: 1[c/r][l/f]

Example response: NG[c/r][l/f]

21: illegal type[c/r][l/f]

1: 250 ms

2: 500 ms

3: 1000 ms

@PHL

Function: Sets ON/OFF for the peak hold function.

Example transmission: @PHL1[c/r][l/f]

Example response: OK[c/r][l/f]

Example response: NG[c/r][l/f]

21: illegal type[c/r][l/f]

@PHL 0: Peak hold OFF

@PHL 1: Peak hold ON

@BHL

Function: Sets ON/OFF for the bottom hold function.

Example transmission: @BHL1[c/r][l/f]

Example response: OK[c/r][l/f]

Example response: NG[c/r][l/f]

21: illegal type[c/r][l/f]

@BHL 0: Bottom hold OFF

@BHL 1: Bottom hold ON

@B

Function: Corrects the zero point.

Example transmission: @B[c/r][l/f]

Example response: OK[c/r][l/f]

Example response: NG[c/r][l/f]

21: illegal type[c/r][l/f]

Note: Turning off power cancels zero point correction.

● Communication time chart

When transmitting @A, @SW

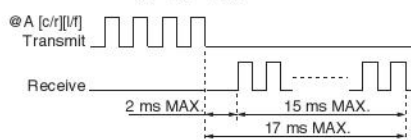

@P(When output mode 2), @PRE When sending

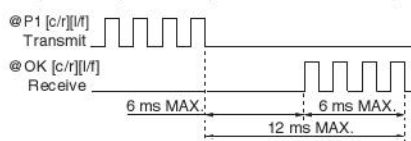

When sending @P(When output mode 3),

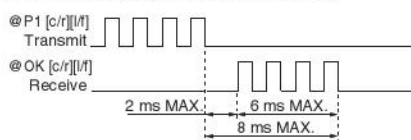

● Communication error codes

20: no start code[c/r][l/f]
No '@' start code.
Input commands starting from '@'.

21: illegal type[c/r][l/f]
A matching communication code cannot be found.
Check the communication command.

22: data over[c/r][l/f]
The threshold value specified by @P is outside the allowable measuring range.
Check the reference flow rates and the ΔL setting.

23: data error[c/r][l/f]
The argument value of the command is not correct.
Input an allowable value.

24: buffer over[c/r][l/f]
The communication buffer has overflowed.
Input a newline code before buffer overflow occurs.

● Configuring communication settings (with HyperTerminal)



Figure 1

Open the file properties dialog box shown above and configure the settings on the "Connect To" tab.

Click "Configure Modem."



Figure 2

Configure baud rate and other settings as shown in Figure 2.

Bits/second (B) : 9600
Data bit (D) : 8
Parity (P) : Odd
Stop bit (S) : 1
Flow control (F) : Xon/Xoff

After all the settings are the way you want, click [OK].



Figure 3

Clicking the "Settings" tab in Figure 1 will display the settings shown in Figure 3. Click the [ASCII Setup] button.



Figure 4

Configure settings a shown in Figure 4 and then click [OK].

This returns to Figure 3.

Click [OK] again.