



Static Electricity Removal Unit Ionizers

Steady Flow Fan Type

DTY-ELF Series

New Series of Fan Type Ionizers!
**Introducing 3 Types of
5 Models!!**



Multi-Function Type Equipped
with Self-Cleaning Function
DTY-ELF14HC



High-Performance Type
DTY-ELF13H DTY-ELF14H



Simple Type
DTY-ELF13 DTY-ELF14

Static Electricity Removal Unit Ionizers

Multi-Function Type Equipped with Self-Cleaning Function

DTY-ELF14HC

Features

- High-performance AC (200 Hz) system.
- Produces **excellent ion balance ($\pm 5V$)** and steady long-term elimination of static electricity.
- Automatic cleaning function means maintenance of discharge needle is not needed.**
- Ozone production is extremely low at less than 0.004 ppm.
- Wide angle louvers provided to eliminate static charge over an extensive range.
- Airflow volume control allows airflow to be adjusted smoothly.
- Equipped with balance indicator so you can confirm balance of positive and negative ions.
- Alarm output function. (detects problems with static discharge, high-voltage circuits, or fan)
- Abnormal ion balance output function.



DTY-ELF14HC

DTY-ELF14HC



Straight-flow louvers



Wide angle louvers (included)



Power signal connector Filter/filter cover

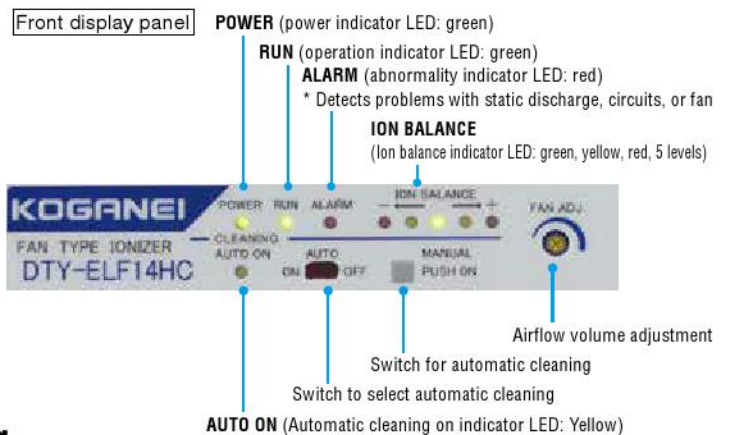

Equipped with automatic cleaning

Dirt on discharge needle is automatically cleaned off by built-in brush.

- Discharge needle is cleaned when power is turned on and once every 24 hours (AUTO setting)
- Discharge needle can also be cleaned by pressing the automatic cleaning switch.

Static Electricity Removal Unit Ionizers

High-Performance Types Have Excellent Long-Term Stability

DTY-ELF13H

DTY-ELF14H

Features

- High-performance AC (200 Hz) system.
- Excellent ion balance
DTY-ELF13H: $\pm 10V$, DTY-ELF14H: $\pm 5V$
- Discharge needle cleaning period
DTY-ELF13H: 3000 hours, DTY-ELF14H: 2000 hours
- Ozone production is extremely low at less than 0.004 ppm.
- Discharge needle unit can be removed and attached with one touch without any tools.
- Wide angle louvers provided to eliminate static charge over an extensive range.
- Airflow volume control allows airflow to be adjusted smoothly.
(Equipped with 5-level airflow indicator)
- Alarm output function. (detects problems with static discharge, high-voltage circuits, or fan)
- CE marking compliant.



● DTY-ELF13H

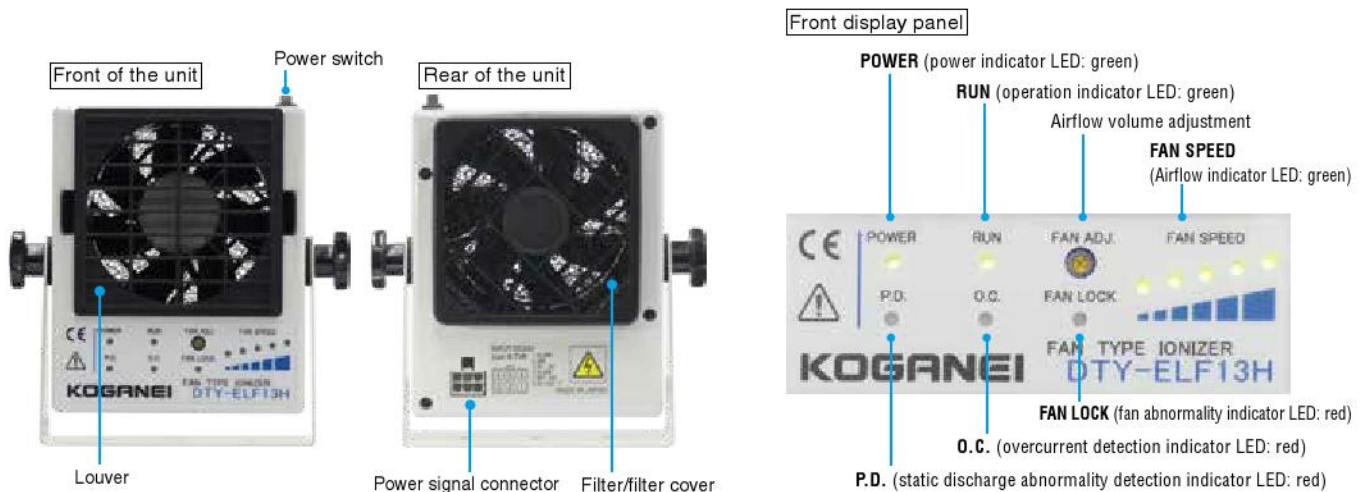

● DTY-ELF14H

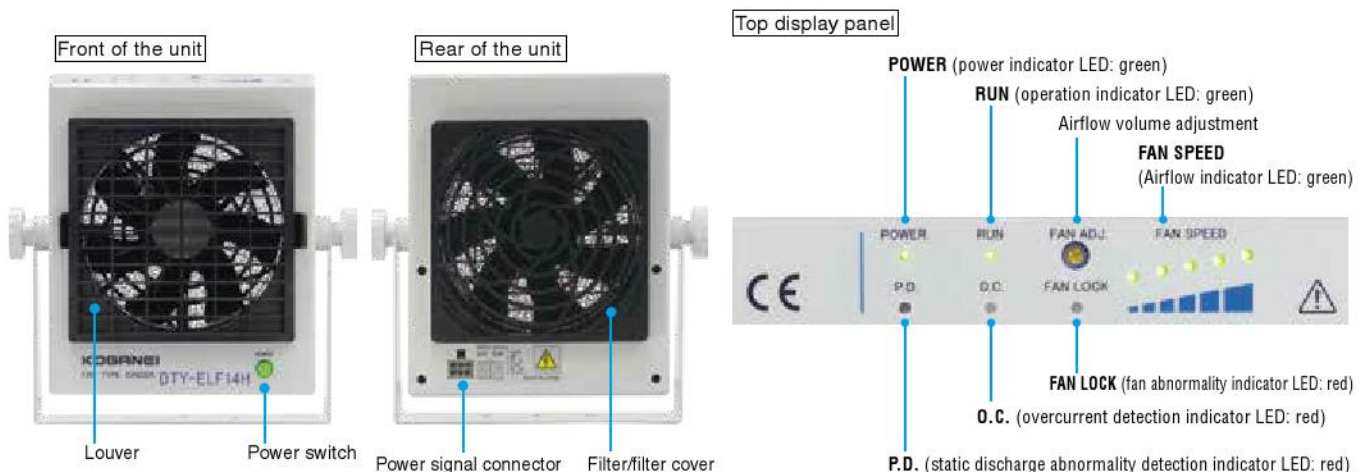

Static Electricity Removal Unit Ionizers

Simple Types Comprising Basic Functions

DTY-ELF13

DTY-ELF14

Features

- High-frequency AC system with stable ion balance (± 10 V)
- Wide angle louvers provided to eliminate static charge over an extensive range.
- Discharge needle unit can be removed and attached with one touch without any tools.
- Airflow volume control allows airflow to be adjusted smoothly.
- Alarm output function. (static discharge abnormality)
- Cleaning check output function. (DTY-ELF14)



● DTY-ELF13



● DTY-ELF14

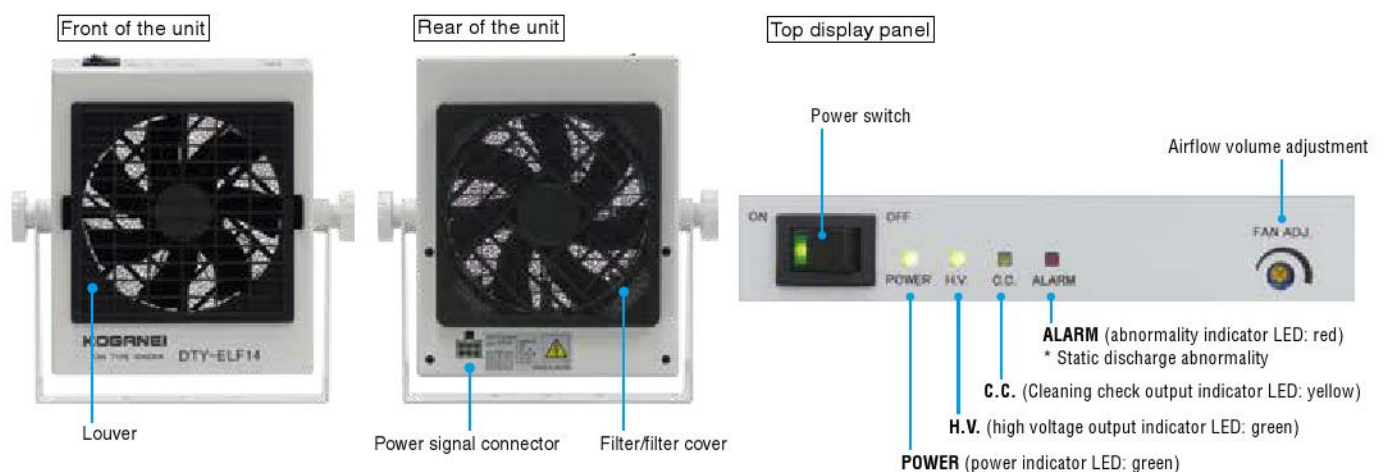

Graphs of Static Charge Elimination Characteristics and Ranges

● DTY-ELF14HC

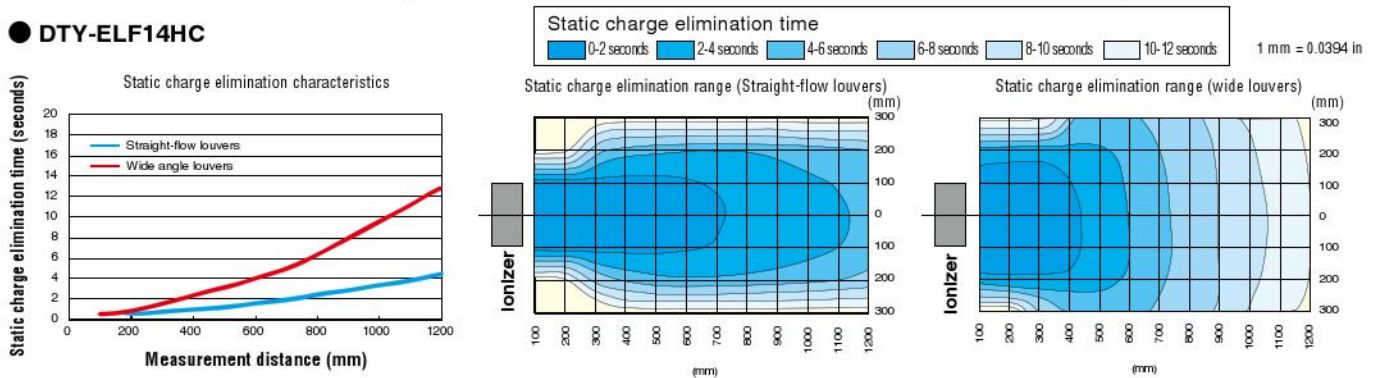

● DTY-ELF13H

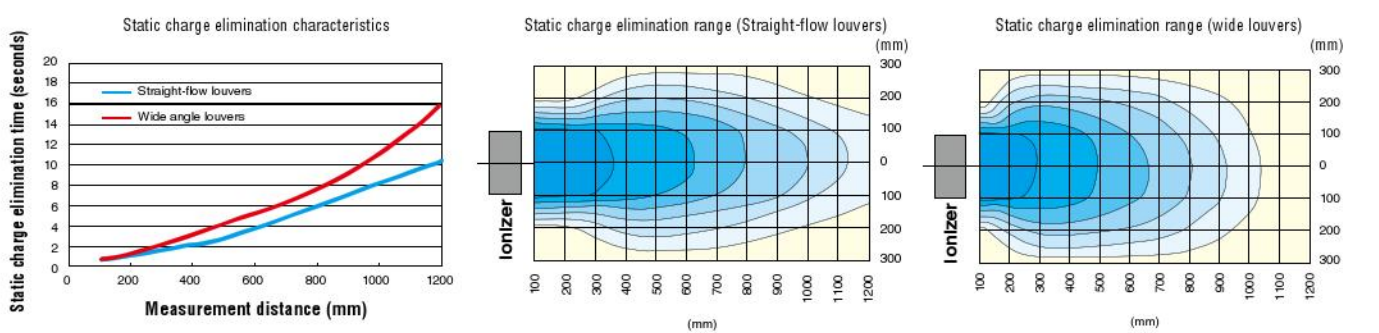

● DTY-ELF14H

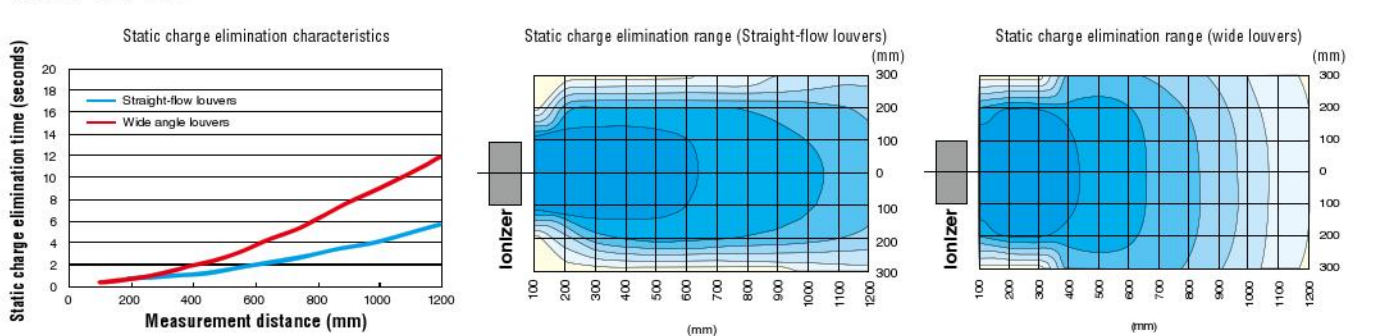

● DTY-ELF13

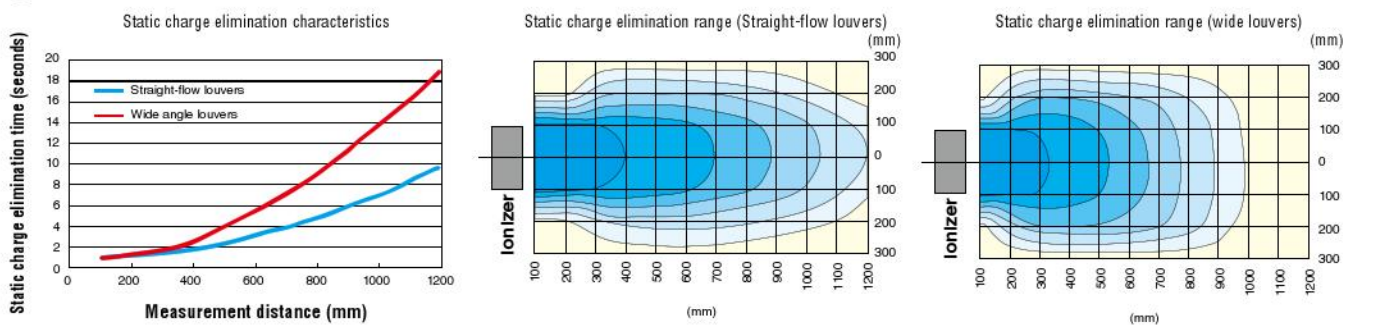



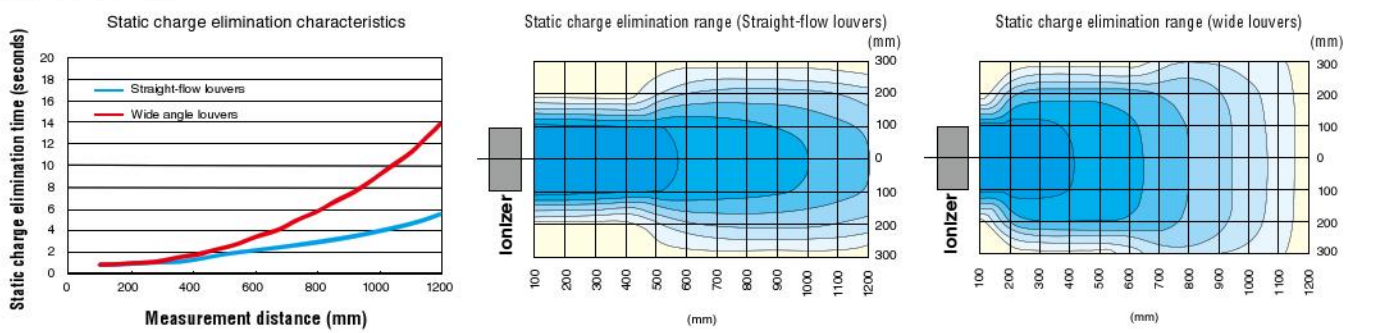

● DTY-ELF14



Note 1: Measurements are made under Koganei measurement conditions, using 20 pF, □ 150 mm [5.9 in] charged plate monitor.

Before selecting and using products, please read all the Safety Precautions carefully to ensure proper product use. The Safety Precautions shown below are to help you use the product safely and correctly, and to prevent injury or damage to assets beforehand. Follow the safety precautions for: ISO4414 (Pneumatic fluid power - General rules and safety requirements for systems and their components) and JIS B 8370 (General rules relating to pneumatic systems).

The directions are ranked according to degree of potential danger or damage: “DANGER!”, “WARNING!”, “CAUTION!”, and “ATTENTION!”

 DANGER	Expresses situations that can be clearly predicted as dangerous. If the noted danger is not avoided, it could result in death or serious injury. It could also result in damage or destruction of assets.
 WARNING	Indicates situations that, while not immediately dangerous, could become dangerous. If the noted danger is not avoided, it could result in death or serious injury. It could also result in damage or destruction of assets.
 CAUTION	Expresses situations that, while not immediately dangerous, could become dangerous. If the noted danger is not avoided, it could result in light or semi-serious injury. It could also result in damage or destruction of assets.
 ATTENTION	While there is little chance of injury, this content refers to points that should be observed for appropriate use of the product.

- **This product was designed and manufactured as parts for use in General Industrial Machinery.**
- When selecting and handling equipment, the system designer or another person with sufficient knowledge and experience should always read the safety precautions, catalog, instruction manual and other literature before commencing operation. Making mistakes in handling is dangerous.
- After reading the instruction manual, catalog, and other documentation, always store them in a location that allows easy availability for reference to users of this product.
- Whenever transferring or lending the product to another person, always attach the catalog, instruction manual, and other information, to the product where they are easily visible in order to ensure that the new user can use the product safely and properly.
- The danger, warning, and caution items listed under these "Safety Precautions" do not cover all possible cases. Read the Catalog and Owner's Manual carefully, and always keep safety first.

 **DANGER**

- Do not use for the applications listed below:
 1. Medical equipment related to maintenance or management of human lives or bodies.
 2. Mechanical devices or equipment designed for the purpose of moving or transporting people.
 3. Critical safety components in mechanical devices.
 This product has not been planned or designed for purposes that require advanced stages of safety. It could cause injury to human life.
- Do not use the product in locations with or near dangerous substances, such as flammable or ignitable substances. This product is not explosion-proof. It could ignite or burst into flames.
- When mounting the product, always firmly support and secure it (including nozzles). Dropping or falling the product or improper operation could result in injury.
- Persons using a pacemaker or other similar medical devices should maintain a distance of at least one meter [3.28 ft] away from the product. Getting too close to the product creates the risk of causing pacemakers to malfunction due to the magnetic fields.
- Never attempt inappropriate disassembly or assembly of the product related to basic construction, performance, or functions. Doing so could cause abnormal operations, injury, electric shock, fire, etc.
- Do not splash water on the product. Spraying water on the product, washing the product, or using the product under water creates the risk of malfunction, leading to injury, electric shock, fire, etc.
- Before doing inspections, cleaning, or maintenance, be sure to turn off the power. Failure to do so creates the risk of electric shock.
- Never attempt to remodel the product. Doing so creates the risk of injury, electric shock, fire, etc. due to abnormal operations.

 **WARNING**

- Do not use the product in excess of its specification range. Doing so creates the risk of product breakdown, loss of function, or damage. It could also drastically reduce the operating life.
- Provide adequate shielding measure for use in the locations described below. Failure to do so creates the risk of abnormal operations, and could cause injury or damage to equipment.
 1. Locations where large electric currents or strong magnetic fields are generated
 2. Locations where there is the possibility of exposure to radiation.
- Use safety circuits or system designs to prevent damage to machinery or injury to personnel when the machine is shut down due to emergency stop or electrical power failure.
- Do not wire parallel to or in the same conduit as power lines or high-voltage lines. Noise may cause devices to malfunction.

- Before supplying electricity to the device and before starting operation, always conduct a safety check of the area where the machine is operating. Unintentional supply of air or electricity could possibly result in electric shock, or in injury caused by contact with moving parts.
- Do not touch the discharge needle, terminals, the miscellaneous switches, etc., while the device is on. There is a possibility of electric shock and abnormal operation.
- Do not throw the product into fire. The product could explode and/or produce toxic gases.
- Do not sit on the product, place your feet on it, or place other objects on it. Accidents such as falling could result in injury. Dropping or toppling the product may result in injury, or it might also damage or break it, resulting in abnormal or erratic operation, runaway, etc.
- Before conducting maintenance, inspection, repair, replacement, or any other similar work, always completely cut off all the electric supply.
- Before performing any kind of wiring work, be sure to turn off the power. Failure to do so creates the risk of electric shock.
- Do not allow any cords, such as the power cords and lead wires, to become damaged. Allowing the cords to be damaged, bent excessively, pulled, rolled up, placed under heavy objects or squeezed between two objects, may result in current leaks or defective continuity that will lead to fire, electric shock, or abnormal operation.
- Do not connect or disconnect connectors while the power is turned on. Also, never apply unnecessary force to connectors. Doing so creates the risk of personal injury, device damage, and electric shock due to abnormal machine operation.
- Check the instruction manual for information to correctly install the product's wiring and piping. Incorrect wiring or piping could result in damage or abnormal operation.
- After completing wiring work, check to make sure that all connections are correct before turning on the power.
- Correctly apply the rated voltage to the product. Applying the wrong voltage will make it impossible to obtain the rated function, and creates the risk of damage to and burnout of the product.
- Do not place the AC adapter cables, or power or signal wires that are provided with the products, on moving parts, because there is a risk the wires may break.
- Stop using the devices if you notice smoke, or strange smells or noises. There is a risk of fire or electric shock.

 **CAUTION**

- Do not use in locations that are subject to direct sunlight (ultraviolet rays), dust, salt, iron powder, or extreme humidity. Do not use in environments that include organic solvents, phosphate ester based hydraulic oil, sulfur dioxide, chlorine gas, or acids. Such conditions can lead to premature loss of functions, sudden degradation of performance, and reduced operating life.

Safety Precautions (Common to All Ionizers)

- Tiny electronic parts are used in the devices. When handling the product, do not hit it, drop it, bump it, or subject it to excessive impact. Even if the exterior of the product appears undamaged, damage to internal components can cause abnormal operation.
- When installing the product, leave room for adequate working space around it. Failure to ensure adequate working space will make it more difficult to conduct daily inspections or maintenance, which could eventually lead to system shutdown or damage to the product.
- Always be sure to post a "Work in Progress" sign during installation, adjustment, or other operations, to avoid unintended supply of electric power, etc. Turning on the power unexpectedly could cause injury due to electric shock or abrupt operations.

ATTENTION

- When considering the possibility of using this product in situations or environments not specifically noted in the Catalog or Owner's Manual, or in applications where safety is an important requirement such as in an airplane facility, combustion equipment, leisure equipment, safety equipment, and other places where human life or assets may be greatly affected, take adequate safety precautions such as an application with enough margins for ratings and performance or failsafe measure.
Be sure to consult us with such applications.
- Check the instruction manual for information to install the product's wiring and piping.
- When handling the product, wear protective gloves, safety glasses, safety shoes, etc., to keep safety.
- When the product can no longer be used, or is no longer necessary, dispose of it appropriately as industrial waste.
- Devices can exhibit degraded performance and function over their operating life. Conduct daily inspections and confirm that all requisite system functions are satisfied to prevent accidents from happening.

Other

- When using the product in a system, use only genuine Koganei parts or compatible parts (recommended parts).
When conducting maintenance and repairs, always use genuine Koganei parts or compatible parts (recommended parts).
Always observe the required methods.

Koganei cannot be responsible if these items are not properly observed.

Safety Precautions for Ionizers

DANGER

- High voltages are applied to the discharge needle, so there is a risk of electric shock. Never touch the discharge needle when the power is on.

WARNING

- The tip of the discharge needle is sharp, so be careful when handling it. Incorrect handling may result in injury.
- Before doing any kind of operation to products that use compressed air, such as maintenance, inspection, repair, connecting or disconnecting piping, or replacements, always turn off the air supply completely and confirm that residual pressure inside the product or in piping connected to the product is zero. In particular, be aware that residual air will still be in the air compressor or air storage tank.
- The medium used by the ionizer is air. Do not use any other medium.
- Always supply air pressure to ionizers that use compressed air before supplying electric power. Supplying electric power while no air pressure is supplied may have a bad effect on the devices and their environment.
- Before applying air pressure, confirm that the discharge needle unit is locked (fastened).

CAUTION

- The ionizer generates ozone while exposed to the atmosphere. Do not use it in particularly enclosed spaces. Furthermore, ventilation is required when multiple units are used.
- Do not place your face near the nozzle of the ion air blower to confirm the smell of ozone. Your nose and throat could become sore.
- Do not use ionizers for any purpose other than removing static charges.
- Before doing piping work, thoroughly flush the inside of the pipes (blow out with compressed air). Machining chips, sealing tape, rust and other debris remaining from the work may result in air leaks and malfunctions.
- Use clean air that contains no oil or moisture as the medium.
- This product cannot be used if the medium or ambient atmosphere includes any of the substances listed below. Organic solvents, phosphate type hydraulic oil, sulfur dioxide gas, chlorine gas, or acids.
- The static charge removal effect may not be achieved, even by spraying ions, if the electrostatically charged object is contiguous to or in contact with another object. When installing the ionizer, be very careful about the environment around the objects from which the charge is to be removed.
- Static charge removal performance is reduced when the ionizer is not fully grounded.
- The operating life of the discharge needle varies depending on the condition of the usage environment. Maintenance is required because loss of performance may occur when the usage environment is poor (such as an atmosphere with high humidity) or when the discharge needle is not clean.
- Note that there is an inrush current when the power is turned on.

Handling Instructions and Precautions (Common Precautions)



General precautions

1. Do not allow excessive external forces to act on the product.
2. Do not disassemble or modify the product.
3. Do not expose the product to ultraviolet light or wind and rain.

Mounting

1. The mounting surface must be flat. Twisting or bending during mounting could result in defective operation.
2. When installing the device, be careful of water and oil contamination, high temperatures, and high humidity. Especially avoid locations on which condensation forms.

Wiring

1. When using a power supply with a commercially available switching regulator, be sure to connect a frame ground (F.G.).
2. When using devices that generate noise (switching regulator, inverter motor, etc.) in the vicinity of the installation, be sure to connect a frame ground (F.G.) to the devices.
3. After completing wiring work, check to make sure that all connections are correct.

Cautions during use

1. Before doing inspections, cleaning, or maintenance, be sure to turn off the power.
2. Always contact Koganei if there is a breakdown, because adjustments and repairs will be necessary.
3. Maintenance is an extremely important aspect for maintaining performance. Do periodic maintenance according to the product's instruction manual.
4. Periodically check that there is no ozone deterioration on devices and components (particularly NBR and other things that have low resistance to ozone) that are used near the ionizer.
5. Do not use with moving parts that are subject to vibration or impact.

Mounting

1. When installing, ensure enough space so that the inlet does not get blocked.

Cautions during use

1. Be sure to remove the AC adapter before doing inspections, cleaning, or maintenance.
2. Failure to do so may result a high voltage being applied to the discharge needle and causing electric shock. Never touch the discharge needle when the power is on.
3. The tip of the discharge needle is sharp, so be careful when cleaning and when removing the discharge needle unit. Failure to do so may result in injury. Also, be very careful so that the discharge needle does not bend or break. If it does, performance may begin to deteriorate.
4. Do not disassemble the discharge needle unit. The tip of the discharge needle is sharp, so doing so may result in injury.
5. Maintenance is an extremely important aspect for maintaining performance. Do periodic maintenance because performance may deteriorate when the usage environment is poor (such as an atmosphere with high humidity) or when the discharge needle is not clean. For how to do maintenance, see the instruction manual attached to the product.
6. After the power is turned on, it takes about five seconds for the fan's rotation to stabilize. To obtain stable performance in eliminating static charge, avoid using the product in this transitional state.



CAUTION Read the "Safety Precautions" on page 5 before using this product.

Warranty and General Disclaimer

1. Warranty Period

The warranty period for Koganei products is 1 year from the date of delivery.

* However, some products have a 2-year warranty; contact your nearest Koganei sales office or the Koganei overseas department for details.

2. Scope of Warranty and General Disclaimer

- (1) When a product purchased from Koganei or from an authorized Koganei distributor or agent malfunctions during the warranty period in a way that is attributable to Koganei's responsibility, Koganei will repair or replace the product free of charge. Even if a product is still within the warranty period, its durability is determined by its operation cycles and other factors. Contact your nearest Koganei sales office or the Koganei overseas department for details.
- (2) The Koganei product warranty covers individual products. Therefore, Koganei is not responsible for incidental losses (repair of this product, various expenses required for replacement, etc.) caused by breakdown, loss of function, or loss of performance of Koganei products.
- (3) Koganei is not responsible for any losses or for any damages to other machinery caused by breakdown, loss of function, or loss of performance of Koganei products.
- (4) Koganei is not responsible for any losses due to use or storage of the product in a way that is outside of the product specifications prescribed in Koganei catalogs and instruction manuals, and/or due to actions that violate the mounting, installation, adjustment, maintenance or other safety precautions.
- (5) Koganei is not responsible for any losses caused by breakdown of the product due to factors outside the responsibility of Koganei, including but not limited to fire, natural disaster, the actions of third parties, and intentional actions or errors by the purchaser.

Specifications

Multi-Function Type (Equipped with Automatic Cleaning)

Item	Model	DTY-ELF14HC	
Input voltage		DC24V±5%	
Consumption current	mA	750	
Output voltage	kV	±7.5	
Indicator LED	POWER (green)	Lit when power is on	
	RUN (green)	Lit when high voltages are applied to electrodes	
	ALARM (red)	Lights when there is a problem with the static discharge, circuits, fan, or cleaning brush	
	ION BALANCE (red, yellow, green)	Indicates ion balance in 5 levels	
	AUTO ON (yellow)	Lights when automatic cleaning is ON	
Output		ALARM LED lights when no-voltage at b contact output (24 VDC, 50 mA MAX)	
		Ion balance abnormal (red LED lights) when no-voltage at b contact output (24 VDC, 50 mA MAX)	
Ion balance ^{Note 1}	V	Within ± 5	
Static charge elimination time ^{Note 1}	seconds	1 or less	
Amount of ozone generated ^{Note 2}	ppm	0.004	
Fan power	Maximum airflow	m ³ /min	3.2
	Control		Smooth control with airflow volume adjustment
External dimensions ^{Note 3}	mm [in.]	150W×182H×75D [5.9×7.2×2.953]	
Weight ^{Note 4}	g [oz]	1240 [44]	
Usage environment		Indoor 0 to 40°C [32 to 104°F], 15 to 85% RH (with no condensation)	
Attachments/accessories		Instruction manual, AC adaptor, wide-angle louvers Output signal lead wires (3-piece set)	

Note 1: At maximum airflow and at a distance of 300 mm [11.8 in.] from the center of the outlet, using Straight-flow louvers

Note 2: At minimum airflow and at a distance of 150 mm [5.9 in.] from the center of the outlet

Note 3: Main unit only, not including brackets or protrusions

Note 4: Including brackets

Comments: Measurements for the ion balance and the static charge elimination time are measured under Koganei measurement conditions.
Contact us for details.

Order Codes

Unit

DTY-ELF14HC



* Output signal lead wires (included)
AC adaptor (included)

Options (sold separately)

● Louvers (quantity: 1)



DTY-ZLS-F4B (Straight-flow)

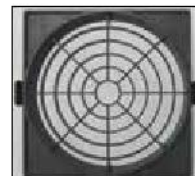

DTY-ZL-FA02 (wide angle)

Options (sold separately)

● Replacement filter (quantity: set of 6)

DTY-ZFR-F4A



● Filter cover (quantity: 1)

DTY-ZFRC-F4A



● AC adaptor

DTY-ZPS5



Rated
Input : 100 to 240 VAC
50/60 Hz 0.58 A
Output: 24 VDC 1 A

● Bracket (1 set)

DTY-ZBK-F4B

* 2 knob bolts included

● Output signal lead wires (2 m [6.562 ft])

DTY-ZSL-3N (3 sets)



Dimensions (mm [in.])

Steady Flow Fan Type

● DTY-ELF14HC

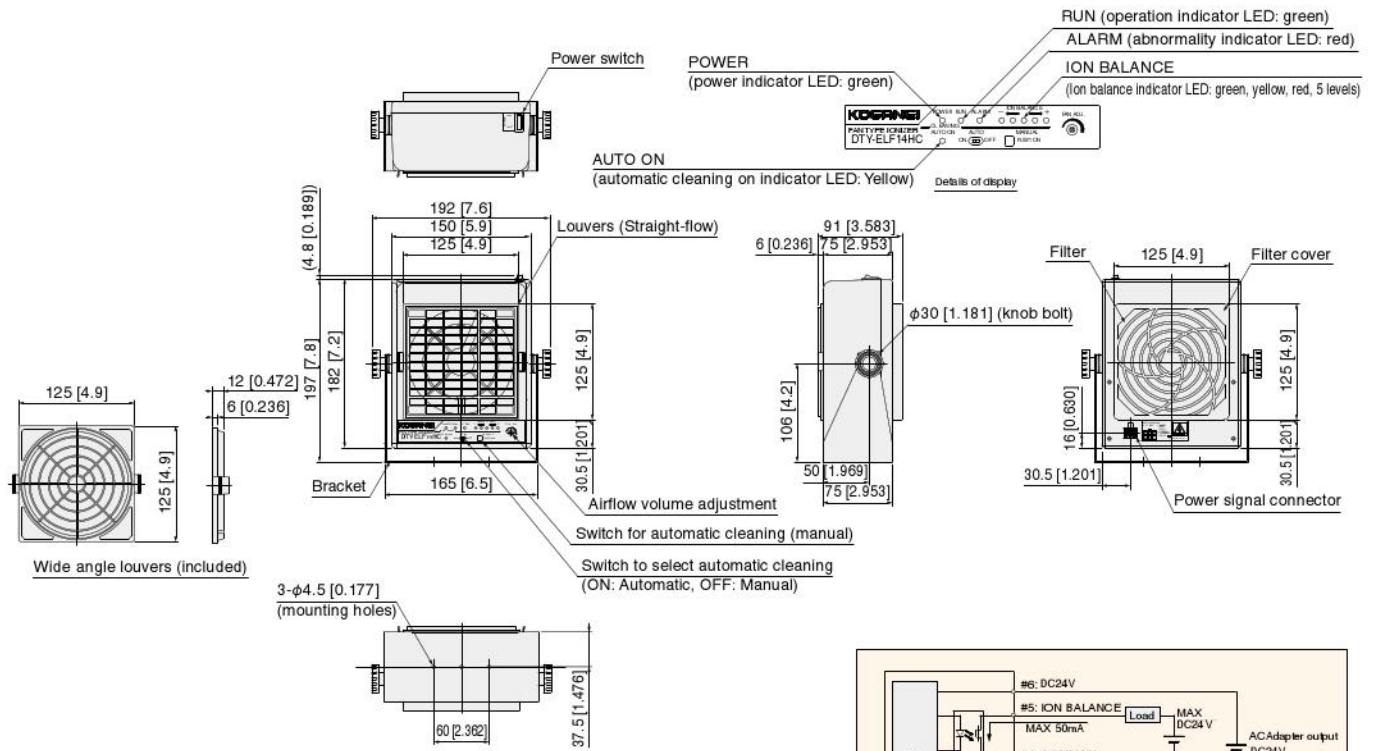

● DTY-ZSL-3N

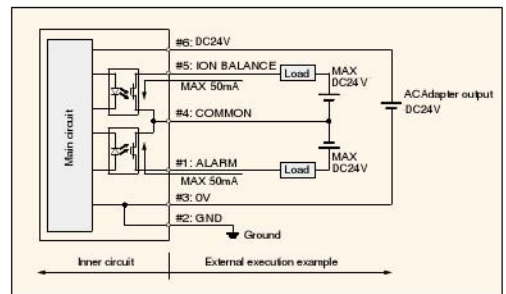
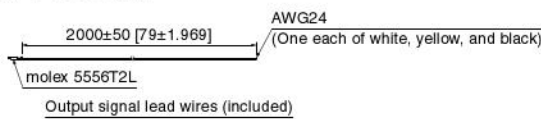

● DTY-ZPS5

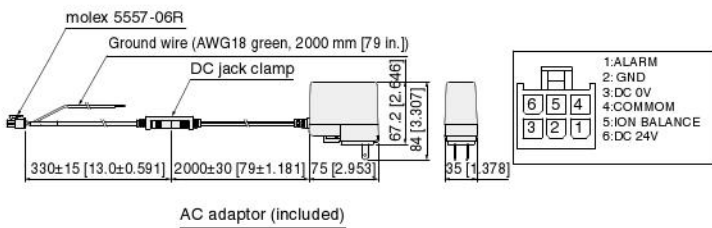

Specifications

High-performance type

Item	Model	DTY-ELF13H	DTY-ELF14H
Input voltage		DC24V±5%	
Consumption current	mA	280	500
Output voltage	kV	±7	±7.5
Indicator LED	POWER (green)	Lit when power is on	
	RUN (green)	Lit when high voltages are applied to electrodes	
	P.D. (red)	Lights when there is a static discharge abnormality	
	O.C. (red)	Lights when there is an overcurrent in the high voltage circuit	
	FAN LOCK (red)	Lit when there is a fan abnormality	
	FAN SPEED (green)	Indicates fan airflow in 5 levels	
Output		Abnormal (red LED) lights when no-voltage at b contact output (24 VDC or less, 50 mA MAX)	
Ion balance ^{Note 1}	V	Within ±10	Within ± 5
Static charge elimination time ^{Note 1}	seconds	2 or less	1 or less
Amount of ozone generated ^{Note 2}	ppm	0.004 or less	
Fan power	Maximum airflow m ³ /min	1.2	3.5
	Control	Smooth control with airflow volume adjustment	
Maintenance period ^{Note 3}		3000 hours	2000 hours
External dimensions ^{Note 4}	mm [in.]	104W×126H×50D [4.1×5.0×1.969]	150W×182H×50D [5.9×7.2×1.969]
Weight ^{Note 5}	g [oz]	570 [20.1]	910 [32.1]
Usage environment		Indoor 0 to 40°C [32 to 104°F], 15 to 85% RH (with no condensation)	
Attachments/accessories		Instruction manual, AC adapter, wide-angle louvers Output signal lead wires (2-piece set), cleaning brush	Instruction manual, AC adapter, conductive wide-angle louvers Output signal lead wires (2-piece set), cleaning brush

Note 1: At maximum airflow and at a distance of 300 mm [11.8 in.] from the center of the outlet, using Straight-flow louvers

Note 2: At minimum airflow and at a distance of 150 mm [5.9 in.] from the center of the outlet

Note 3: Varies depending on usage environment and conditions

Note 4: Main unit only, not including brackets or protrusions

Note 5: Including brackets

Comments: Measurements for the ion balance and the static charge elimination time are measured under Koganei measurement conditions. Contact us for details.

Order Codes

Unit

DTY-ELF13H



* Output signal lead wires (included)
AC adaptor (included)

DTY-ELF14H



* Output signal lead wires (included)
AC adaptor (included)

Options (sold separately)

● Straight-flow louvers (quantity: 1)

DTY-ZLS-F3A (for DTY-ELF13H)

DTY-ZLS-F4A (for DTY-ELF14H)

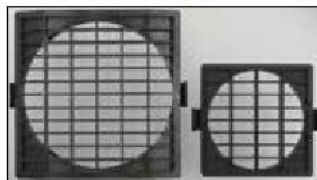

● Wide angle louvers (quantity: 1)

DTY-ZLW-F3A (for DTY-ELF13H)

DTY-ZLW-F4A (for DTY-ELF14H)

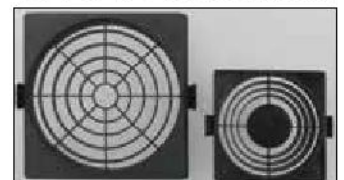

Options (sold separately)

● Replacement discharge needle unit (quantity: 1)

DTY-ZEM-F3A (for DTY-ELF13H)

DTY-ZEM-F4A (for DTY-ELF14H)



● Bracket (1 set)

DTY-ZBK-F3A (for DTY-ELF13H)

* 2 knob bolts, 2 rubber gaskets included

DTY-ZBK-F4A (for DTY-ELF14H)

* 2 knob bolts included

● Replacement filter (quantity: set of 6)

DTY-ZFR-F3A (for DTY-ELF13H)

DTY-ZFR-F4A (for DTY-ELF14H)

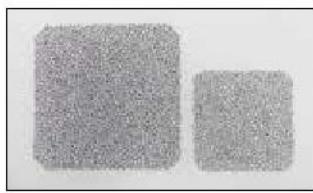

● AC adapter

DTY-ZPS5



Rated
Input : 100 to 240 VAC
50/60 Hz 0.58 A
Output: 24 VDC 1 A

● Filter cover (quantity: 1)

DTY-ZFRC-F3A (for DTY-ELF13H)

DTY-ZFRC-F4A (for DTY-ELF14H)

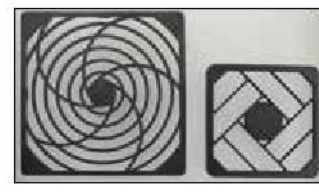

● Output signal lead wires (2 m [6.562 ft])

DTY-ZSL-FA (2-piece set)



Dimensions (mm [in.])

Steady Flow Fan Type

● DTY-ELF13H

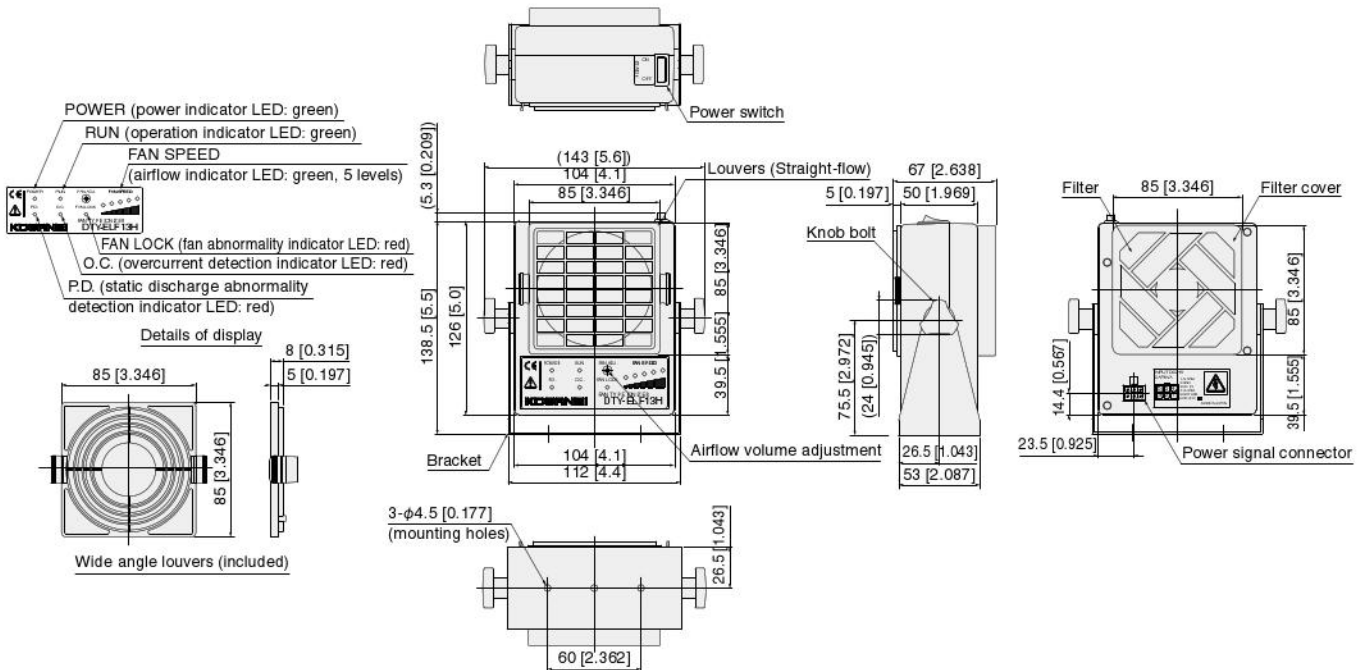

● DTY-ELF14H

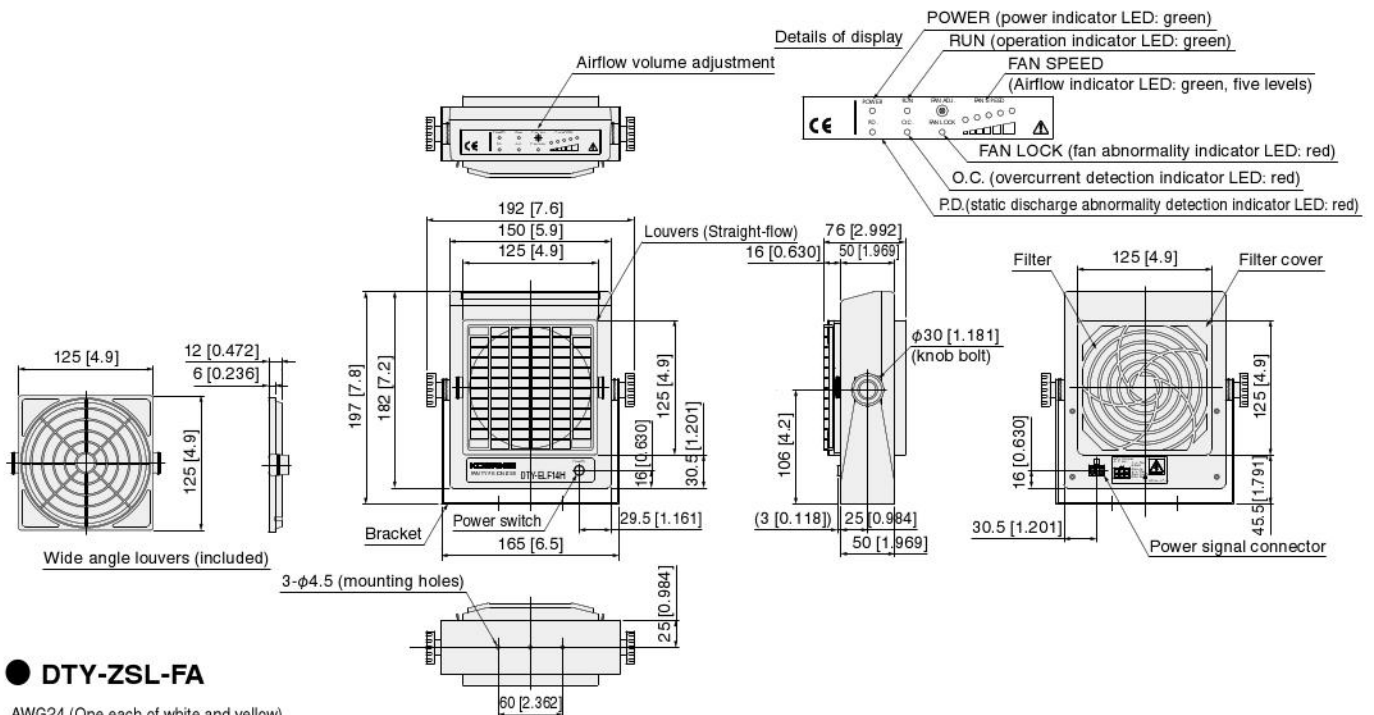

● DTY-ZSL-FA

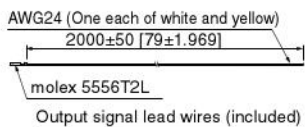

● DTY-ZPS5

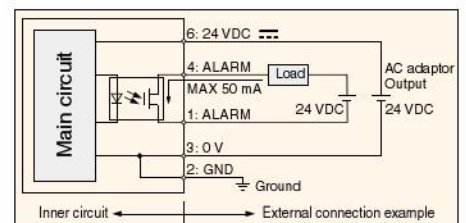
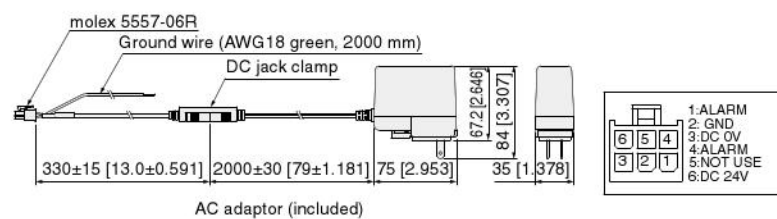

Specifications

Simple types

Item		Model	DTY-ELF13	DTY-ELF14
Main unit input voltage			DC24V±5%	
Consumption current		mA	360	410
Output voltage		kV	2.5 (high-frequency type)	3 (high-frequency type)
Indicator LED	POWER (green)		-	Lit when power is on
	H.V. (green)		Lights when operations are normal	
	C.C. (yellow)		-	Lights at cleaning check (electrode is dirty)
	ALARM (red)		Lights when static discharge is abnormal (H.V. LED (green) off)	
Output			ALARM LED lights when no-voltage at b contact output (24 VDC, 50 mA MAX)	ALARM LED lights when no-voltage at a or b contact output (24 VDC, 50 mA MAX) C.C. LED lights when no-voltage at a contact output (24 VDC, 50 mA MAX)
Ion balance		Note 1 V	Within ±10	
Static charge elimination time		Note 1 seconds	2 or less	1.5 or less
Amount of ozone generated		Note 2 ppm	0.04 or less	
Fan power	Maximum airflow	m ³ /min	1.7	3.3
	Control		Smooth control with airflow volume adjustment	
Maintenance period		Note 3	300 hours	
External dimensions		Note 4 mm [in.]	104W×126H×50D [4.1×5.0×1.969]	150W×182H×50D [5.9×7.2×1.969]
Weight		Note 5 g [oz]	450 [15.9]	810 [28.6]
Usage environment			Indoor 0 to 40°C [32 to 104°F], 15 to 65% RH (with no condensation)	
Attachments/accessories			Instruction manual, AC adapter, wide-angle louvers Output signal lead wires (2-piece set), cleaning brush	Instruction manual, AC adapter, wide-angle louvers Output signal lead wires (3-piece set), cleaning brush

Note 1: At maximum airflow and at a distance of 300 mm [11.8 in.] from the center of the outlet, using Straight-flow louvers

Note 2: At minimum airflow and at a distance of 150 mm [5.9 in.] from the center of the outlet

Note 3: Varies depending on usage environment and conditions

Note 4: Main unit only, not including brackets or protrusions

Note 5: Including brackets

Comments: Measurements for the ion balance and the static charge elimination time are measured under Koganei measurement conditions. Contact us for details.

Order Codes

Unit

DTY-ELF13



* Output signal lead wires (included)
AC adaptor (included)

DTY-ELF14



* Output signal lead wires (included)
AC adaptor (included)

Options (sold separately)

- Straight-flow louvers (quantity: 1)
DTY-ZLS-F3A (for DTY-ELF13)
DTY-ZLS-F4B (for DTY-ELF14)

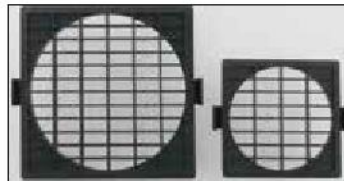

- Wide angle louvers (quantity: 1)
DTY-ZLW-F3A (for DTY-ELF13)
DTY-ZL-FA02 (for DTY-ELF14)

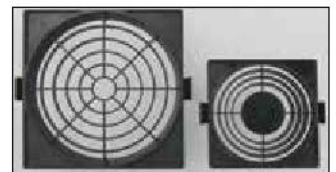

Options (sold separately)

- Replacement discharge needle unit (quantity: 1)
DTY-ZEM-F3A (for DTY-ELF13)
DTY-ZEM-FA (for DTY-ELF14)
- Replacement filter (quantity: set of 6)
DTY-ZFR-F3A (for DTY-ELF13)
DTY-ZFR-FA (for DTY-ELF14)
- Filter cover (quantity: 1)
DTY-ZFRC-F3A (for DTY-ELF13)
DTY-ZFRC-FA (for DTY-ELF14)

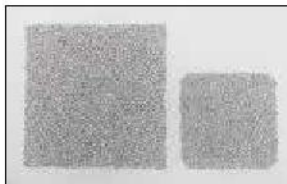

- Bracket (1 set)
DTY-ZBK-F3A (for DTY-ELF13)
* 2 knob bolts, 2 rubber gaskets included

- **DTY-ZBK-F4A** (for DTY-ELF14)
* 2 knob bolts included

- Cleaning brush
DTRY-ZBR

- AC adapter
DTY-ZPS5



Rated
Input : 100 to 240 VAC
50/60 Hz 0.58 A
Output: 24 VDC 1 A

- Output signal lead wires (2 m [6.562 ft])
DTY-ZSL-FA (for DTY-ELF13, 2-piece set)
DTY-ZLS-3N (for DTY-ELF14, 3-piece set)



Dimensions (mm [in.])

Steady Flow Fan Type

● DTY-ELF13

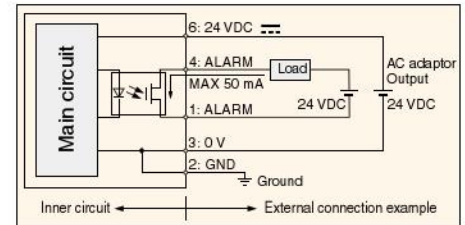
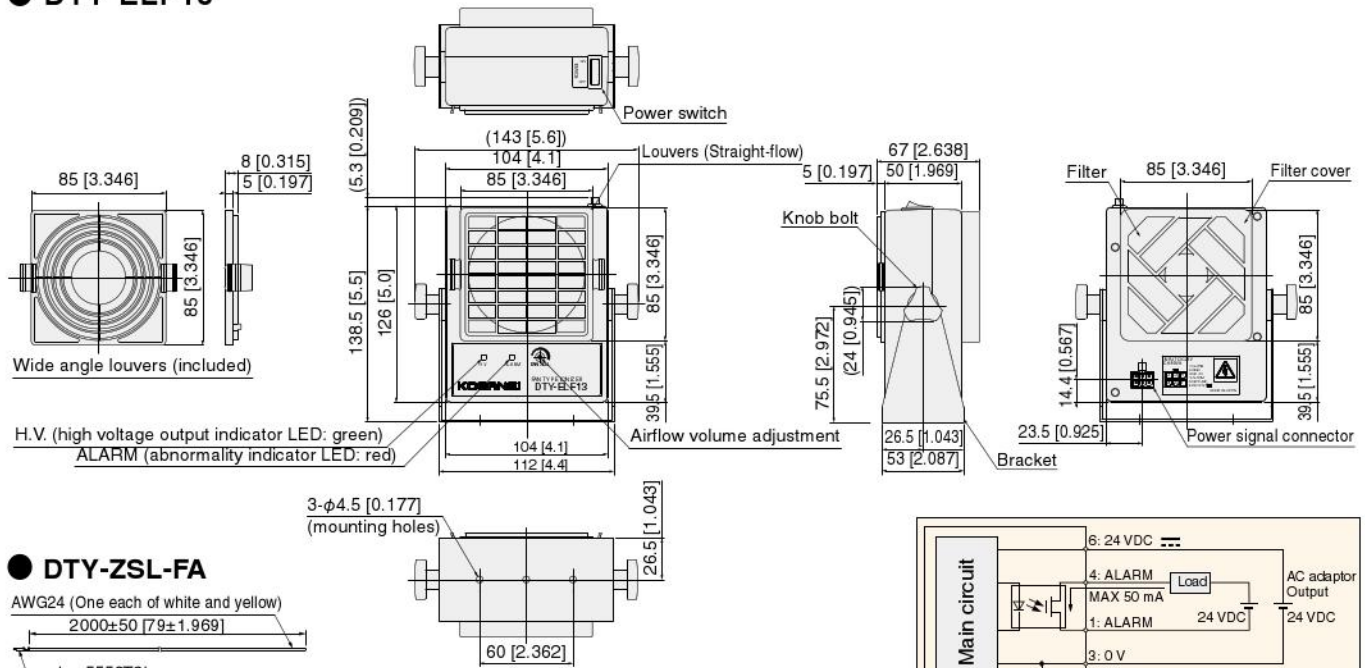

● DTY-ELF14

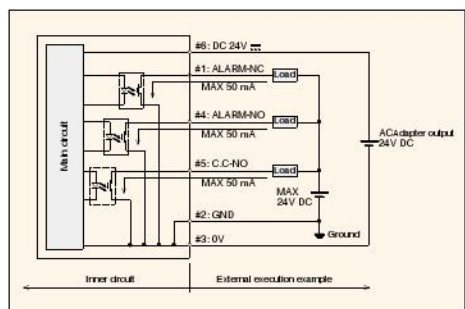
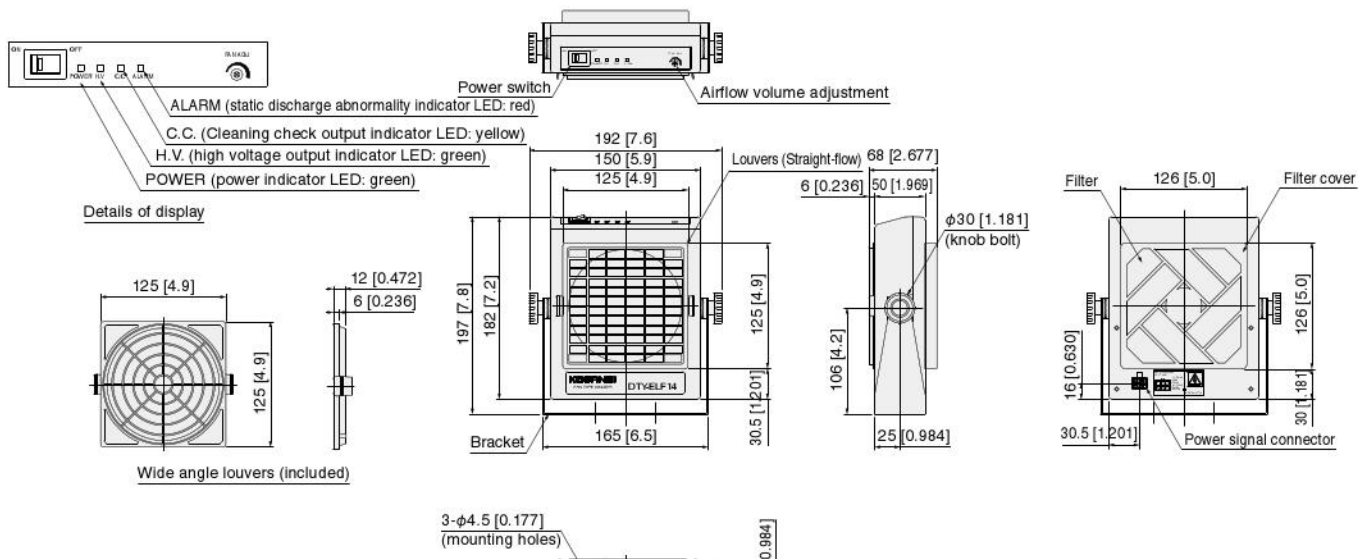

● DTY-ZSL-3N

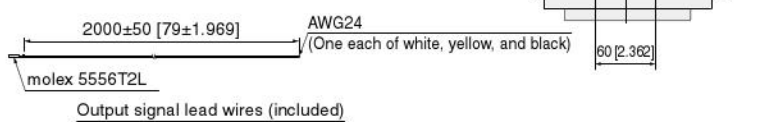

● DTY-ZPS5

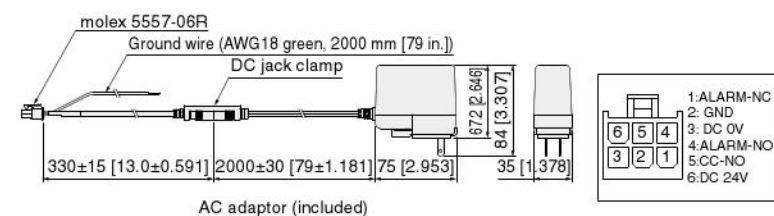

Limited Warranty

KOGANEI CORP. warrants its products to be free from defects in material and workmanship subject to the following provisions.

Warranty Period The warranty period is 180 days from the date of delivery.

Koganei Responsibility If a defect in material or workmanship is found during the warranty period, KOGANEI CORP. will replace any part proved defective under normal use free of charge and will provide the service necessary to replace such a part.

Limitations

- This warranty is in lieu of all other warranties, expressed or implied, and is limited to the original cost of the product and shall not include any transportation fee, the cost of installation or any liability for direct, indirect or consequential damage or delay resulting from the defects.

- KOGANEI CORP. shall in no way be liable or responsible for injuries or damage to persons or property arising out of the use or operation of the manufacturer's product.

- This warranty shall be void if the engineered safety devices are removed, made inoperative or not periodically checked for proper functioning.

- Any operation beyond the rated capacity, any improper use or application, or any improper installation of the product, or any substitution upon it with parts not furnished or approved by KOGANEI CORP., shall void this warranty.

- This warranty covers only such items supplied by KOGANEI CORP. The products of other manufacturers are covered only by such warranties made by those original manufacturers, even though such items may have been included as the components.

The specifications are subject to change without notice.

URL <http://www.koganei.co.jp>

E-mail: overseas@koganei.co.jp



KOGANEI CORPORATION

OVERSEAS DEPARTMENT

3-11-28, Midori-cho, Koganei City, Tokyo 184-8533, Japan
Tel: 81-42-383-7271 Fax: 81-42-383-7276

KOGANEI International America, Inc.

48860 Milmont Drive, Suite 108C Fremont, CA 94538, U.S.A
TEL: (+1)510-744-1626 FAX: (+1)510-744-1676

SHANGHAI KOGANEI INTERNATIONAL TRADING CORPORATION

RM2606-2607, Tongda Venture Building NO.1 Lane 600, Tianshan Road, Shanghai, China
TEL: (+86)021-6145-7313 FAX: (+86)021-6145-7323

TAIWAN KOGANEI TRADING CO., LTD

Rm.2, 16F., No88, Sec.2, Zhongxiao E. Rd., ZhongZheng Dist., Taipei City 10050, Taiwan (ROC)
TEL: (+886)02-2393-2717 FAX: (+886)02-2393-2719

KOGANEI KOREA CO., LTD

A-3001, Heungdeok IT Valley Bldg., Heungkeok 1-ro, 13, Giheung-gu, Yongin-si, Gyeonggi-do, 446-908, KOREA
TEL: (+82)31-246-0414 FAX: (+82)31-246-0415

KOGANEI (THAILAND) CO., LTD

555 Rasa Tower I, Unit 1207, 1202, 12th floor, Phaholyothin Road, Chatuchak, Chatuchak, Bangkok 10900 Thailand
TEL: (+66)02-513-1228 FAX: (+66)02-513-1232

KOGANEI ASIA PTE. LTD.

69 Ubi Road 1, #05-18 Oxley Bizhub Singapore 408731
TEL: (+65)6293-4512 FAX: (+65)6293-4513