





**Safety Precautions (Static Electricity Removing Unit IONIZER) Always read these precautions carefully before use.**

Before selecting and using products, please read all the Safety Precautions carefully to ensure proper product use. The Safety Precautions shown below are to help you use the product safely and correctly, and to prevent injury or damage to assets beforehand. Follow the Safety Precautions for: ISO4414 (Pneumatic fluid power--Recommendations for the application of equipment to transmission and control systems), JIS B 8370 (Pneumatic system regulations)

The directions are ranked according to degree of potential danger or damage: **“DANGER!” “WARNING!” “CAUTION!” and “ATTENTION!”**

 <b>DANGER</b>	Expresses situations that can be clearly predicted as dangerous. If the noted danger is not avoided, it could result in death or serious injury. It could also result in damage or destruction of assets.
 <b>WARNING</b>	Expresses situations that, while not immediately dangerous, could become dangerous. If the noted danger is not avoided, it could result in death or serious injury. It could also result in damage or destruction of assets.
 <b>CAUTION</b>	Expresses situations that, while not immediately dangerous, could become dangerous. If the noted danger is not avoided, it could result in light or semi-serious injury. It could also result in damage or destruction of assets.
 <b>ATTENTION</b>	While there is little chance of injury, this content refers to points that should be observed for appropriate use of the product.

- This product was designed and manufactured as parts for use in General Industrial Machinery.
- In the selection and handling of the equipment, a system designer or other person with fully adequate knowledge and experience should always read the Safety Precautions, Catalog, Instruction Manual and other literature before commencing operation. Making mistakes in handling is dangerous.
- After reading the Instruction Manual, etc., always place the Manual where it can be easily available for reference to users of this product.
- If transferring or lending the product to another person, always attach the Instruction Manual, etc., to the product where it is easily visible, to ensure that the new user can use the product safely and properly.
- The danger, warning, and caution items listed under these "Safety Precautions" do not cover all possible cases. Read the catalog and user's manual carefully, and always keep safety first.

 **DANGER**

- Do not use for the purposes listed below:
  1. Medical equipment related to maintenance or management of human lives or bodies.
  2. Mechanical devices or equipment designed for the purpose of moving or transporting people.
  3. Critical safety components in mechanical devices.
 This product has not been planned or designed for purposes that require advanced stages of safety. It could cause injury to human life.
- Do not use in locations with or near dangerous substances such as flammable or ignitable substances. This product is not explosion-proof. It could ignite or burst into flames.
- When attaching the product, always ensure that it is securely fixed in place. Dropping or falling the products, or improper operation could result in injury.
- The Ionizer generates high voltages. Do not disassemble, adjust, or remodel the device, because it can be very dangerous. Such action could result in a malfunction, injury, electric shock, fire, etc.
- Do not splash water on the product. Spraying it with water, washing it, or using it underwater could result in malfunction of the product leading to injury, electric shock, fire, etc.
- Always shut off power when inspecting, cleaning and performing maintenance. Leaving the power ON could result in electric shocks.
- Never touch the discharging needle while the device is plugged in. You may receive electrical shock as a high voltage is applied to the discharging needle.
- Never remodel the product, otherwise you could be injured by such as abnormal operations.

 **WARNING**

- Do not use this product in excess of its specification range. Such use could result in product breakdowns, cessation of function, shutdown or damage. It could as well result in a significant reduction of its service life.
- Before supplying air or electricity to the device and before starting operation, always conduct a safety check of the area of machine operation. Careless supply of air or electricity could possibly result in electric shocks, or in injury caused by contact with moving parts.
- Do not touch the discharging needles, the terminals and/or the miscellaneous switches, etc., while the device is plugged in. There is the possibility of electric shock and abnormal operation.
- Do not allow the product to be thrown into fire. The product could explode and release toxic gases.
- Do not sit on the product, place your foot on it, or place other objects on it. Accidents such as falling and tripping over could result in injury. Dropping the product may damage or break the product resulting in abnormal, improper or erratic operation.
- Handle the discharging needle with caution, since it has a sharp-pointed tip. Wrong handling of it could result in body injury.
- Before performing product maintenance/inspection, piping connection/disconnection or replacement of products using compressed air, be sure to isolate the air supply completely and make sure that the pressure inside the product and the piping to which the product is connected are exhausted. Especially note that the air compressor and the air storage tank will have air residue.
- Always shut off power when performing wiring work. Leaving the power ON could result in electric shocks.
- Avoid scratching the cords of the sensor switch lead wires, etc. Letting the cords be subject to scratching, excessive bending, pulling, rolling up, or being placed under heavy objects or squeezed between two objects, may result in current leaks or defective continuity that lead to fires, electric shocks, or abnormal operation.
- Do not pull out the connectors while the power is ON. Also, do not apply unnecessary stress on the connector. It could result in erratic equipment operation that could lead to personal injury, equipment breakdown, or electrical shocks, etc.
- Always check the Instruction Manual to ensure that the product wiring and piping are done correctly. Errors in wiring and piping could lead to abnormal operation of the product, etc.
- After wiring work, always check to ensure that no wiring connection errors exist before turning on the power. When the + side and the - side of the power supply wiring are connected in reverse, a failure will occur.
- Media used for the Blow Type is air, never use other than the air.
- Always supply the power of the blow type ionizer with applying air. Otherwise, bad effects on the main unit and its surroundings may occur.
- Do not use the supplied cable for AC adapter or power and signal cables included in the products for a moving section. Otherwise, they may break down.

## Handling Instructions and Precautions (for IONIZER)

### CAUTION

- When mounting the product, leave room for adequate working space around it. Failure to assure adequate working space will make it more difficult to perform daily inspections or maintenance, which could eventually lead to system shutdown or damage to the product.
- The Ionizer emits ozone into an atmosphere. If a single unit is operated, ozone will reach the saturation point and will not increase beyond the certain level. However, if several units are operated simultaneously and if you smell ozone, pay attention to the ventilation of the ambient. Do not attempt to check the smell of ozone by directly bringing your face close to the outlet of ionized air flow, since you might get your nose and throat hurt.

### ATTENTION

- When considering the possibility of using this product in situations or environments not specifically noted in the Catalog or Instruction Manual, or in applications where safety is an important requirement, such as in an airplane facility, combustion equipment, leisure equipment, safety equipment and other places where human life or assets may be greatly affected, take adequate safety precautions such as applications with enough margins or fail-safe measures for ratings and performance. Please consult KOGANEI with any questions.
- Always check the Instruction Manual and other reference materials for product's wiring and piping.
- When handling the product, wear protective gloves, safety glasses, safety shoes, etc., to ensure safety.
- When the product can no longer be used, or is no longer necessary, dispose of it appropriately as industrial waste.
- Do not use the Ionizer for any other purpose than the static electricity removal.

### OTHER

- Always observe the following items.
  1. When using this product in pneumatic systems, always use genuine KOGANEI parts or compatible parts (recommended parts). When conducting maintenance and repairs, always use genuine KOGANEI parts or compatible parts (recommended parts). Always observe the required procedures.
  2. Do not attempt inappropriate disassembly or assembly of the product relating to basic configurations, or its performance or functions.

KOGANEI cannot be responsible if these items are not properly observed.



### General precautions

1. Before plumbing, thoroughly flush the pipe's inside with compressed air. Metal chips, sealant tape and rust generated during plumbing could cause clogging and/or malfunction.
2. Use clean air. No vapor and oil are allowed.
3. The Ionizer cannot be used when the media or ambient atmosphere contains the following: organic solvents, phosphate ester type hydraulic oil, sulphur dioxide, chlorine gas or acid.
4. Do not apply excessive external force to the device.
5. Do not disassemble or remodel the product.
6. Do not expose the product to ultraviolet light or weathering.

### Installation

1. Install the unit on a flat surface. If the unit is installed with distortion or bending, a malfunction may occur.
2. For installation of the unit, pay attention to the contamination by oil/water, high temperatures or high humidity. Especially, avoid a place subject to dew condensation.
3. Even when blowing the ionized air onto a charged object while it is getting close to or getting contact with the others, you could not expect the desired effect of removing static charges.  
When installing the Ionizer, pay particular attention to ambient conditions of an object from which to remove static charges.
4. If the Ionizer is not grounded properly, static charge removal level will be reduced.

### Precautions on Use

1. Before inspections, cleaning, or maintenance, be sure to switch off power supply.
2. In the case of a failure, always consult Koganei for adjustment or repair of the product.
3. Periodic maintenance is required to maintain performance. Perform periodic maintenance according to the Instruction Manual of the product.
4. The service life of the discharging needle varies depending on the environmental conditions where it is used. A poor operating environment (e.g., very humid conditions) or failure to clean the discharging needle will lead to degraded performance of the discharging needle. Hence, periodic maintenance is required.
5. Care should be taken to wire correctly. When the + side and the - side of the power supply wiring are connected in reverse to the main unit of the Ionizer, a failure will occur.
6. Do not use the product at a moving section of a device under shock and vibration.
7. Do not use the cable for AC adapter or power supply and signal cables provided with the products, for a moving section. Otherwise, they may break down.

## Static Electricity Removing Unit IONIZER

# STEADY FLOW FAN TYPE

### Features

- Available in three models in accordance with where to install, and type of applications, thanks to no air supply requirement.
- Changeable louver enables selection of static charge removal area.
- Improved maintenance by detachable louver and discharging needle unit.
- Flow rate adjusting knob enables you to obtain the required air flow rate.
- High frequency AC method provides good ion balance. (within  $\pm 10$  V)
- CE marking compliant products



### Discharging Needle Unit

During maintenance, the discharging needle unit can be removed for cleaning, eliminating any concern about particles uncovered during cleaning falling onto the interior of the body. (cleaning brush for discharging needle included)



### Air Flow Rate Adjusting Knob

Using the adjusting knob enables stepless air flow rate adjustment.

### Selector Switch of Abnormality Output Contact Point

Contact point is switchable between NO (a-contact) and NC (b-contact). (Dedicated protection sticker for selector switch of contact included)

### Connector



Front of the unit

### Straight-flow Louver <sup>Note</sup>

Ionized straight air flow through the louver removes static charges on the front of the product powerfully and directly. Straight-flow louver and wide-angle louver in the accessory are interchangeable.

### Wide-angle louver <sup>Note</sup>

Dispersed ionized air through the louver removes static charges in a broader range.



Note: A safety circuit will shut the unit off when the louver is removed during operation.

### Power Switch



Rear of the unit

### Filter / Filter Cover

The filter cover can be removed. IONIZER of these models can be used without the filter.



### Ground terminal

Photo: DTRY-ELF03

## Steady Flow Fan Type Application Examples

- **Static charge removal for parts on a work bench**

Removes static charges from various parts when assembling

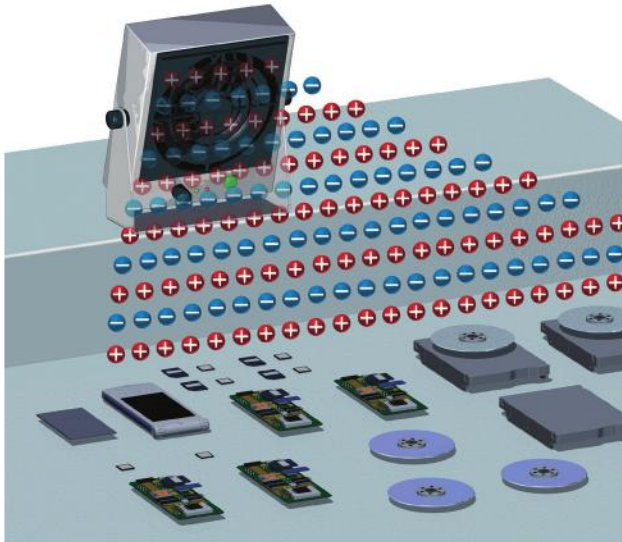

- **Static charge removal for circuit boards etc.**

You can make static charge removal for relatively wide objects.

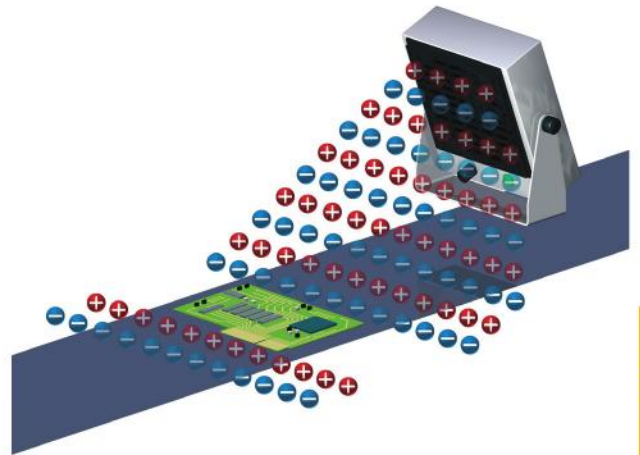

STEADY FLOW  
FAN TYPE

- **Static charge removal for packaging films etc.**

You can remove the static electricity generated when the film leaves the film roller.

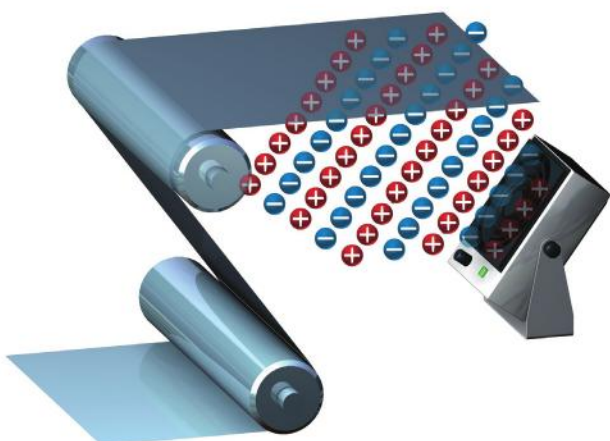

- **Static charge removal for plastic containers and parts etc.**

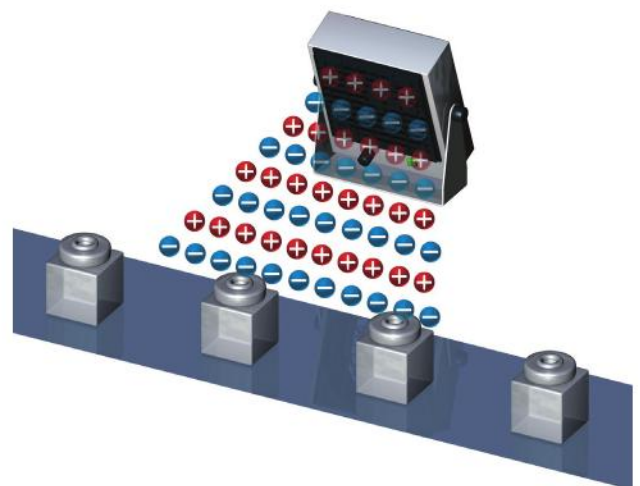

## Graphs of Static Charge Removing Characteristics / Static Charge Removal Range of Straight-flow and Wide-angle Louver (image)

### ● DTRY-ELF02

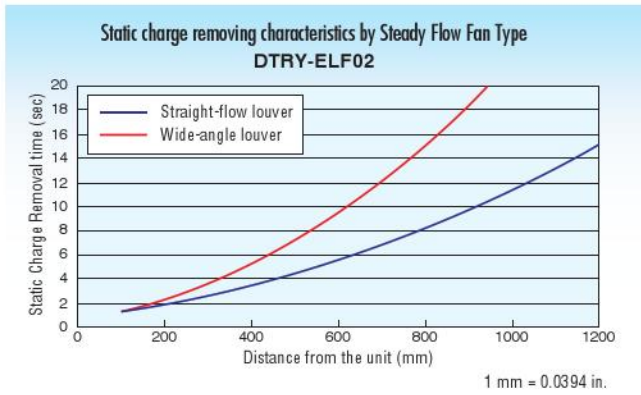

### ● Static charge removal range when the straight-flow louver is used

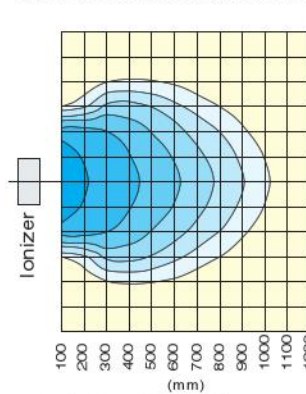

### ● Static charge removal range when the wide-angle louver is used

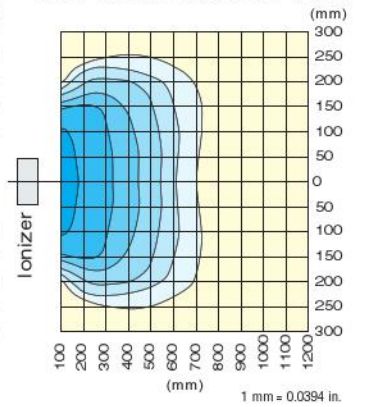

### ● DTRY-ELF03

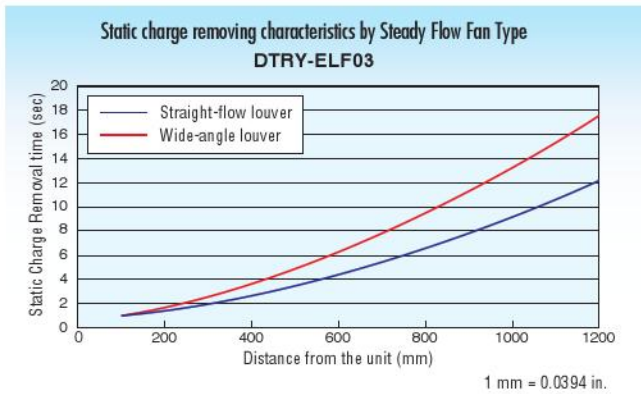

### ● Static charge removal range when the straight-flow louver is used

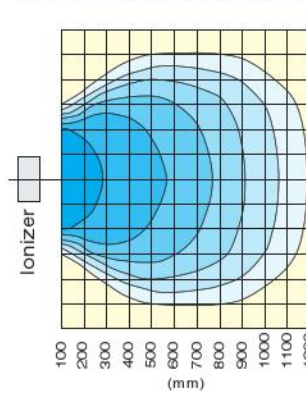

### ● Static charge removal range when the wide-angle louver is used

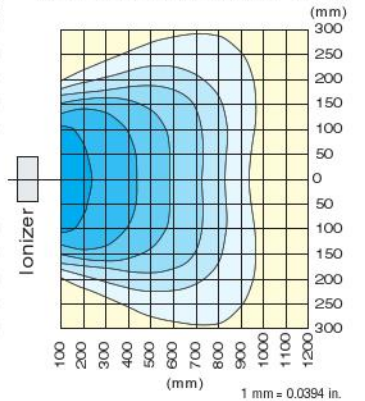

### ● DTRY-ELF04

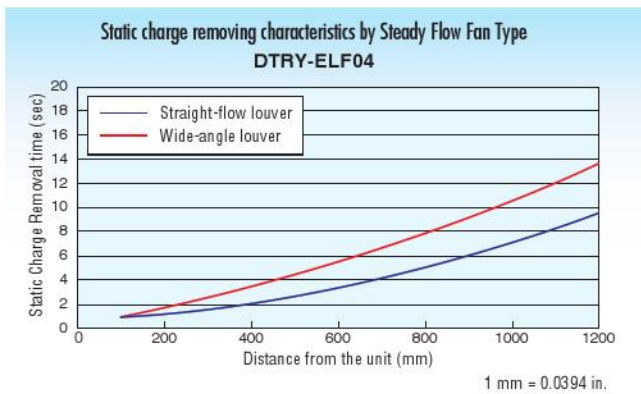

### ● Static charge removal range when the straight-flow louver is used

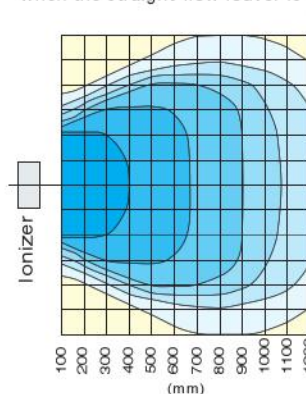

### ● Static charge removal range when the wide-angle louver is used

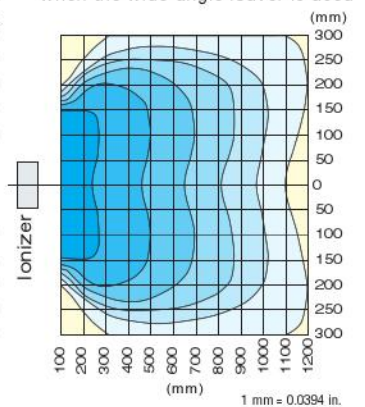

Notes 1: The static charge removing characteristics are measured by in-house test standard using the charged plate monitor of 20 pF, 150 mm.

2: The static charge removal time means decaying time from ± 1000 V to ± 100 V at the max. flow rate without filter.

3: The static charge removing characteristics were measured from the center of the fan outlet.

# Specifications

## Steady Flow Fan Type

Item	Model	DTRY-ELF02	DTRY-ELF03	DTRY-ELF04	
Power supply		24VDC ±5%			
Consumption current	mA	200	210	350	
Output voltage	kV	Approx. 2 (high frequency type)			
Indicator	Power supply	While the Power Switch is pushed ON, the Power Switch (Green) and the H.V. power indicator LED (Green) on the front of the main unit turn on.			
LED	Abnormality	When an abnormality occurs during discharge, the abnormality indicator LED (Red) on the front of the main unit turns on.			
Power safety circuit		The contact point output NO/NC is selectable when an abnormal discharge occurs. <sup>Note 1</sup> (24 VDC, 50 mA Max.)			
Outer dimension	<sup>Note 2</sup> mm	61 (L) × 80 (W) × 100 (H)	62 (L) × 100 (W) × 120 (H)	62 (L) × 140 (W) × 160 (H)	
Mass	<sup>Note 3</sup> g [oz.]	400 [14.1]	520 [18.3]	830 [29.3]	
Ion balance	<sup>Note 4</sup> V	±10			
Static charge removal time	<sup>Note 4</sup> sec.	3 or less	2.2 or less	1.5 or less	
Ozone generation amount	<sup>Note 4</sup> ppm	0.04 or less			
Fan	Max. flow rate	m <sup>3</sup> /min [ft <sup>3</sup> /min]	0.5 [17.7]	1.1 [38.8]	3.0 [105.9]
capacity	Adjustment	Stepless adjustment by using the flow rate adjusting knob			
Operating ambient temperature	°C [°F]	0 ~ 40 [32 ~ 104] (avoid a place subject to dew condensation)			
Accessories		User's manual, 1 pc. wide-angle louver, 1 pc. power and signal cable (2 m[78.7in.]), 1 pc. ground lead wire (2 m[78.7in.]), 1 pc. rear filter, 1 pc. cleaning brush for discharging needle, and 1 pc. contact point selector switch protection sticker			

Notes 1: For output of abnormality output contact point, see page 41.

2: When a bracket and a filter removed (Does not include protruding portions).

3: When a bracket and a filter removed.

4: 300 mm [11.8in.] from the center of the fan outlet, at maximum flow rate when the straight-flow louver used.

Remark: Ion balance and static charge removal time were measured by in-house test standard. Contact us for more detail.

STEADY FLOW FAN TYPE

## Order code

### STEADY FLOW FAN TYPE

#### Main unit

DTRY-ELF02



Wide-angle louver (accessory)

DTRY-ELF03



Wide-angle louver (accessory)

DTRY-ELF04



Wide-angle louver (accessory)

#### Option

● Discharging needle unit for replacement (sales unit: 1 pc.)

● Rear filter for replacement (sales unit: a set of 5 pcs.)

DTRY-ZEM-F02  
(for DTRY-ELF02)

DTRY-ZEM-F03  
(for DTRY-ELF03)

DTRY-ZEM-F04  
(for DTRY-ELF04)

DTRY-ZFR-F02  
(for DTRY-ELF02)

DTRY-ZFR-F03  
(for DTRY-ELF03)

DTRY-ZFR-F04  
(for DTRY-ELF04)

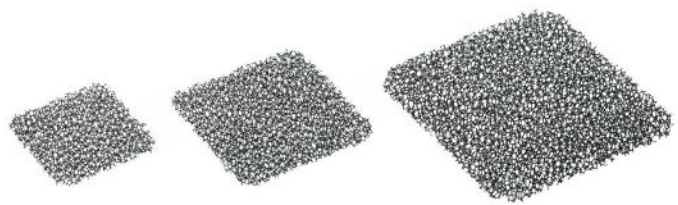
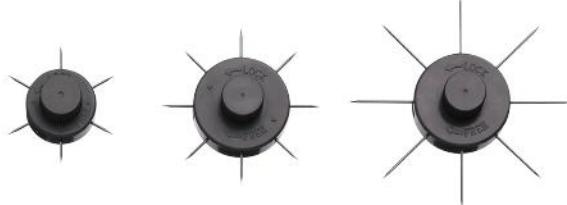

● AC adapter  
DTRY-ELC04

Rating  
Input: 100 VAC thru 240 VAC  
50/60 Hz 0.6 A  
Output: 24 VDC 750 mA



● Component bracket  
DTRY-ELF31

Only for DTRY-ELF02



● Power signal cable (2m)  
DTRY-ADN-DSC

● Earth lead wires (2m)  
DTRY-ADN-YGC

● Cleaning brushes (sales unit: 3pcs)  
DTRY-ZBR

● Straight-flow louver (sales unit: 1pc)  
DTRY-ZLS-F02 (for DTRY-ELF02)  
DTRY-ZLS-F03 (for DTRY-ELF03)  
DTRY-ZLS-F04 (for DTRY-ELF04)

● wide-angle louver (sales unit: 1pc)  
DTRY-ZLW-F02 (for DTRY-ELF02)  
DTRY-ZLW-F03 (for DTRY-ELF03)  
DTRY-ZLW-F04 (for DTRY-ELF04)

● Bracket (2 knob bolts, 2 rubber gaskets included)  
DTRY-ZBK-F02 (for DTRY-ELF02)  
DTRY-ZBK-F03 (for DTRY-ELF03)  
DTRY-ZBK-F04 (for DTRY-ELF04)

## Dimensions (mm)

### STEADY FLOW FAN TYPE

#### ● DTRY-ELF02

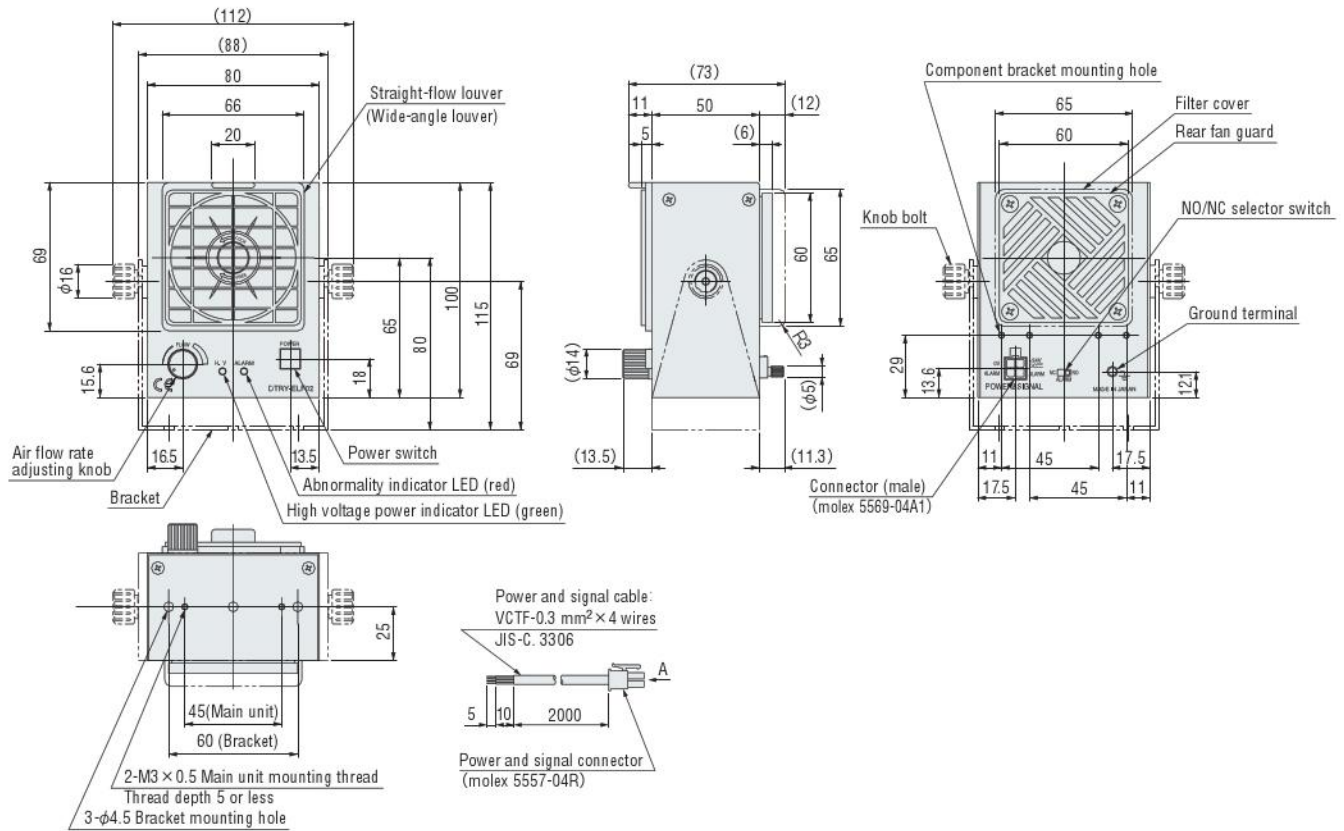

#### ● DTRY-ELF03

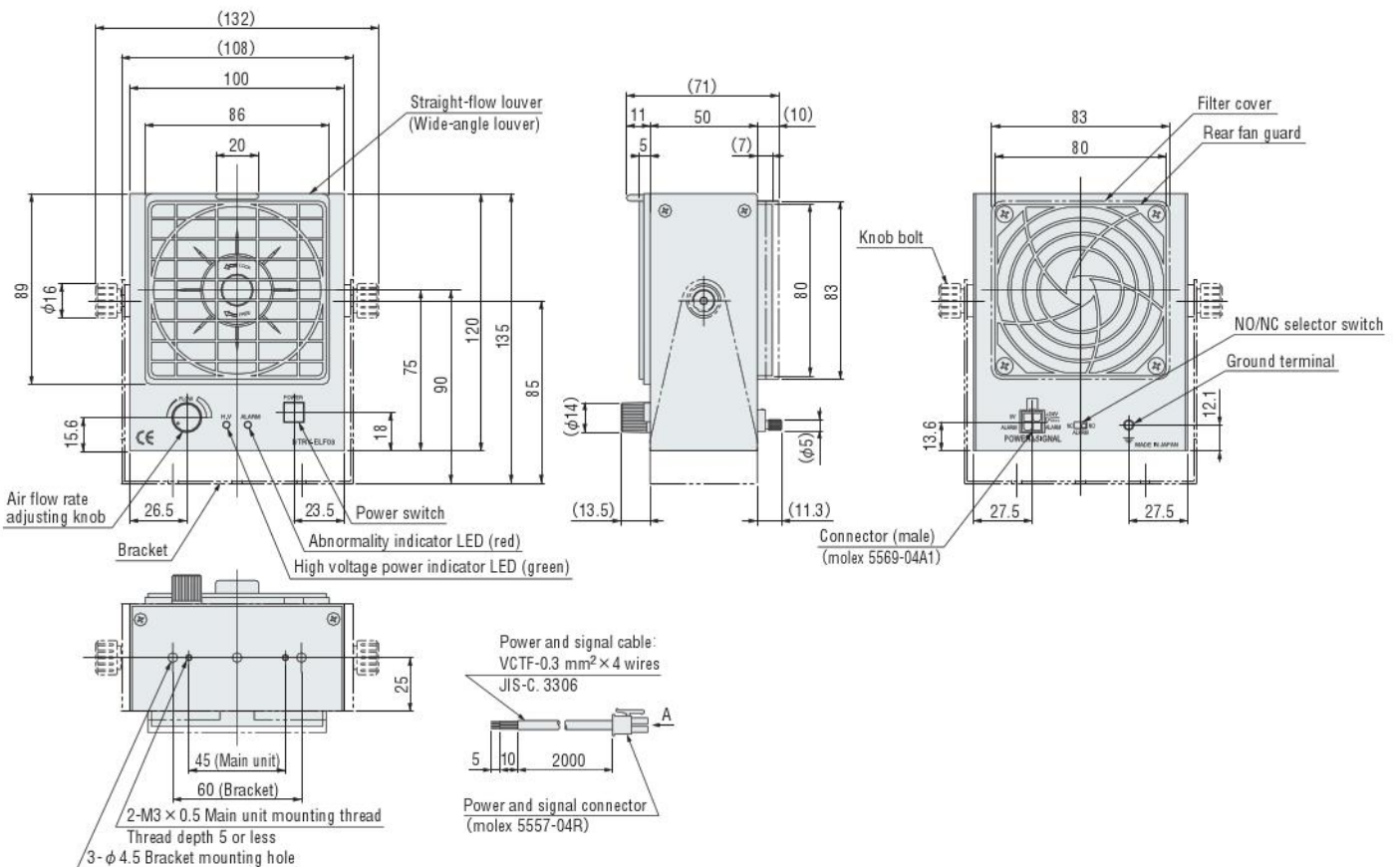

● DTRY-ELF04

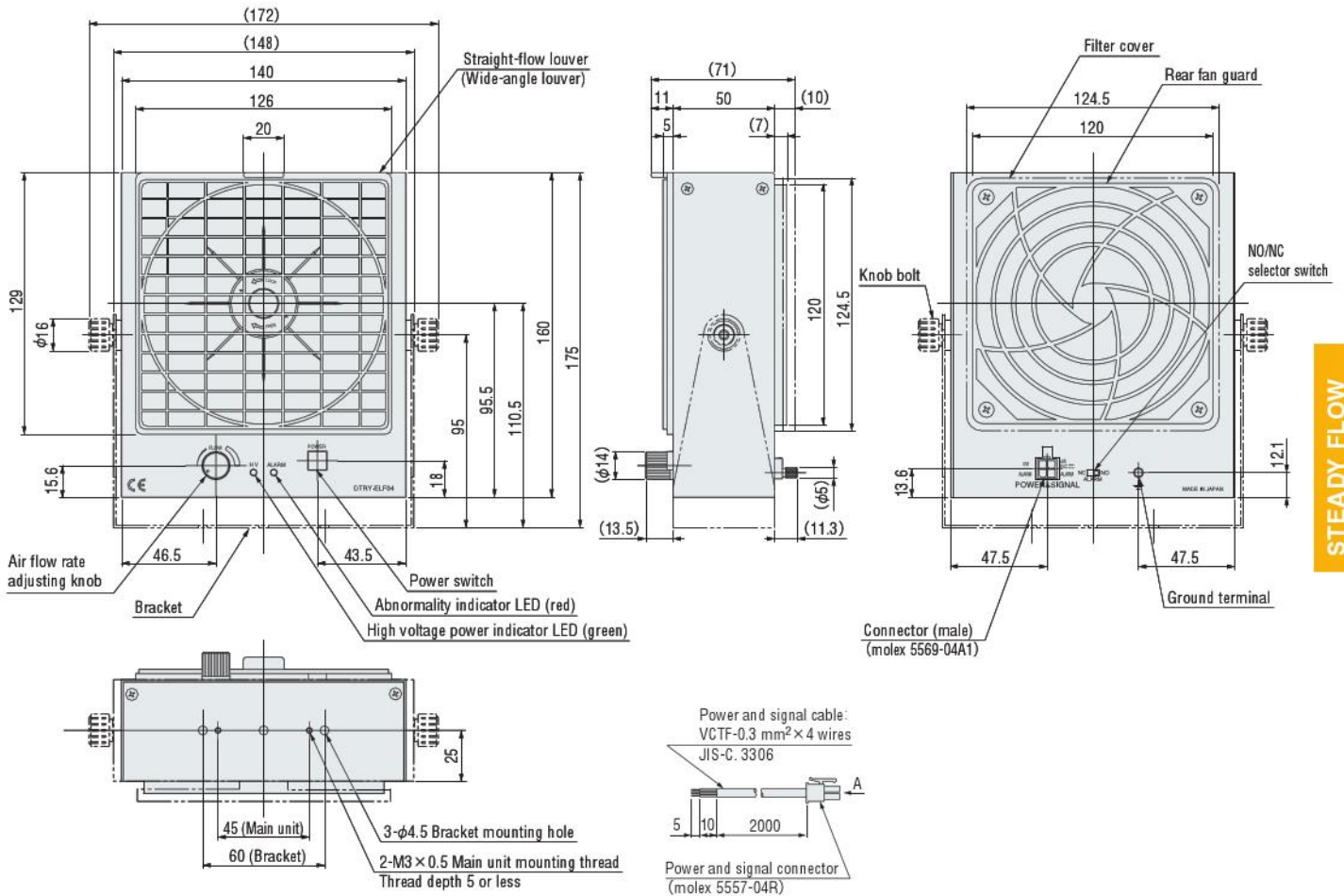

STEADY FLOW FAN TYPE

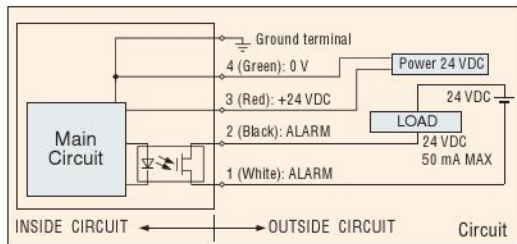
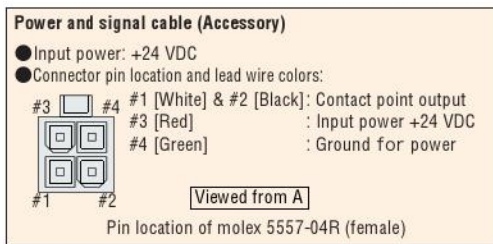

- Notes 1: ON/OFF of the power to the ionizer should be done at the input side ( +24 VDC side)  
 2: Ground for power and ground terminal are connected inside  
 3: For output of abnormality output contact point, see page 41.

## Handling Instructions and Precautions (for STEADY FLOW FAN TYPE)

### Installation

1. When mounting, do not thread mounting screws in 5mm or deeper; otherwise the mounting screws may contact the inner circuit board. It could result in damage to the product.
2. When installing, ensure sufficient space so as not to block the suction opening.

### Precaution on Use

1. Before inspections, cleaning, or maintenance, be sure to disconnect a power cable from a connector.
2. The discharging needle has a sharp-pointed tip. Handle the discharging needle unit with care when removing or cleaning it. Otherwise it could possibly result in injury. Pay attention not to bend or break a discharging needle. Otherwise, you could not get the desired effect.
3. Do not disassemble the discharging needle unit. Since the discharging needle has a sharp-pointed tip, you could be injured.
4. A poor operating environment (e.g., very humid conditions) or failure to clean the discharging needle will lead to degraded performance of the ionizer. Hence, periodic maintenance is required to maintain performance. For maintenance, refer to the supplied instruction manual.
5. To turn ON/OFF externally, make it the input on +24 VDC side.

### Output of abnormality output contact point

1. The abnormality output circuit of this product will be active normally about 2 seconds later after being turned on. Sufficient care should be taken to design an error detection circuit at the time of the unit installation on other equipment, etc.
2. When the power to the main unit of the ionizer is turned on immediately after being turned off, an abnormality output may occur. When performing such an operation, be sure to wait at least 2-second or longer after turning off.
3. Caution should be exercised to design the error detection circuit not to detect the ionizer's abnormality output for one second after turning off the power to the ionizer main unit.

Note: Either of the above cases, no problem with the ionizer performance.

For output at the time of setting each contact point, see the table below.

Setting MODE	Power OFF	Power ON	Abnormality
NO (a-contact)	OPEN	OPEN	CLOSE
NC (b-contact)	OPEN	CLOSE	OPEN

※ For the precautions for IONIZER, see page ④.