

Koganei Clean System products provide complete support for the maintenance of a clean environment inside the cleanroom.

Koganei Clean System products meet the needs of the ultra-clean production environment. In everything from actuators and valves to air preparation and auxiliary equipment, anti-corrosion materials processing and other Koganei-developed design concepts serve to prevent particle contamination within the cleanroom. These perfectly designed mechanisms, which resolve even the slightest leaks to the outside during operations, have already won a high level of reliability.

Koganei Cleanliness

There is currently no standard in JIS or elsewhere for methods of evaluating cleanliness for pneumatic equipment in the cleanroom specifications. Therefore, to measure the effects of cleanroom contamination by pneumatic equipment, Koganei has decided to use "number of particles generated per 10 operations," rather than particle density. Koganei has also developed classifications for application classes in cleanroom, based on JIS and other upper limit density tables, and on the company's own experience.

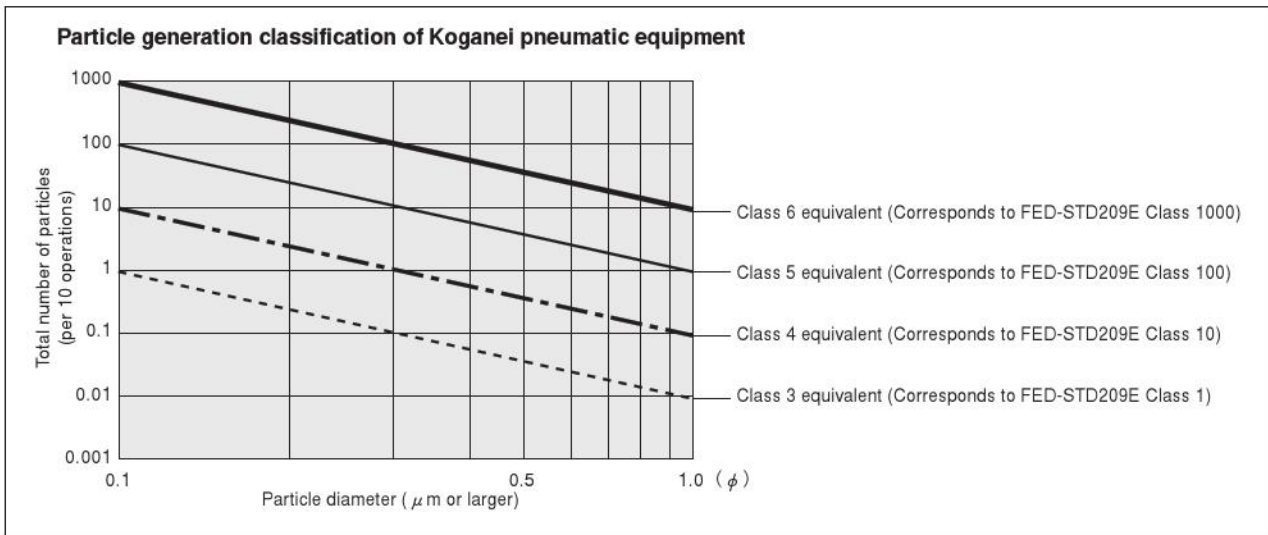

- Remarks:
1. In the above table, product performance in terms of the number of particles generated per 10 operations is expressed as the upper limit of particles corresponding to the equivalent JIS or ISO class.
 2. In the above table, values in the JIS, ISO, and FED-STD upper limit density tables are calculated as upper density per liter.
 3. The classes shown are clean levels as classified in JIS and ISO.

From the above definitions, the Koganei clean level classes can be viewed as the level of average contamination per liter of surrounding air over a period of 10 operations in cleanroom. Air ventilation in cleanrooms is usually faster than 1 cycle per minute, and clean volumetric capacity is usually larger than 1 liter, which should provide a sufficient safety margin in practice.

Caution: The above conclusions are based on an ideal situation in which air ventilation is being implemented. For specific cases where air ventilation is not ensured, caution is needed since the clean classes cannot be maintained.

The clean system diagrams shown here are for Class 5 equivalent products. For Class 4 or Class 3 equivalent products, consult us.

Evaluations of Cleanliness

Koganei has therefore specified its in-house measurement methods, to conduct evaluations on the cleanroom rating.

The number of particles of the Air Cylinder Cleanroom Specification is measured as shown in the method below.

1. Measurement conditions

1-1 Test circuit: Figure 1 (no suction), Figure 2 (with suction)

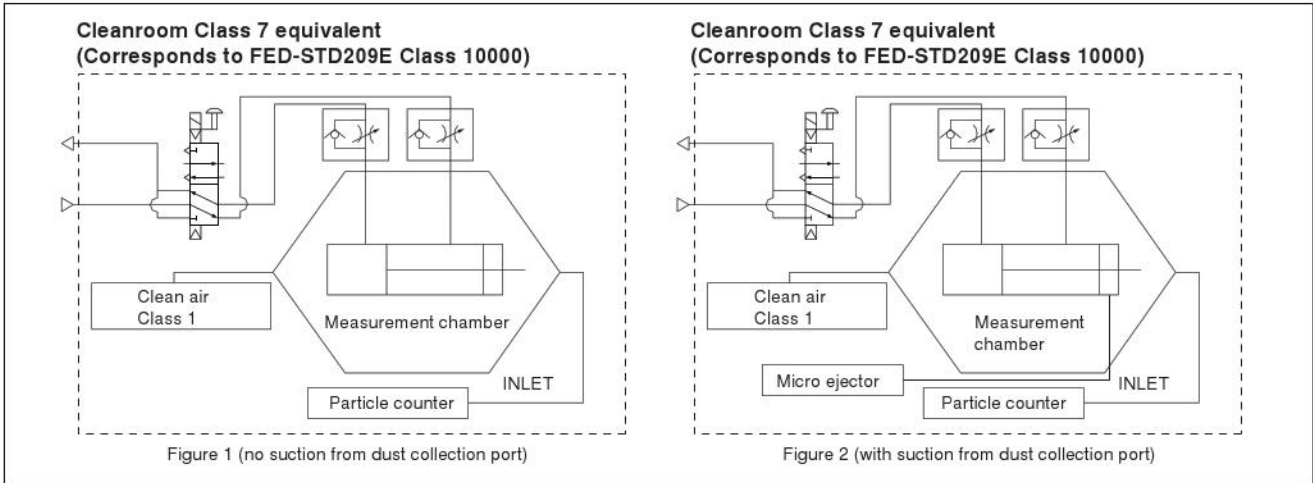

1-2 Operating conditions of tested cylinder

Operating frequency: 1Hz

Average speed: 500mm/s [20in./sec.]

Applied pressure: 0.5MPa [73psi.]

Suction condition: Microejector ME05, Primary side: 0.5MPa [73psi.] applied, Tube: $\phi 6$ [0.236in.]

Mounting direction: Vertical

Chamber volume: 8.3 ℓ [0.293ft³]

2. Particle counter

Manufacturer/model: RION/KM20

Suction flow rate: 28.3 ℓ /min [1ft³/min.]

Particle diameter: 0.1 μm , 0.2 μm , 0.3 μm , 0.5 μm , 0.7 μm , 1.0 μm

3. Measurement method

3-1 Confirmation of number of particles in the measurement system

Under the conditions in the above 1 and 2, using a particle counter to measure the sample for 9 minutes without operating the measurement sample, and confirmed the measured number of particle is 1 piece or less.

3-2 Measurement under operation

Under the conditions in the above 1 and 2, operating the measurement sample for 36 minutes, and measured the total values in the latter half of 18 minutes test.

3-3 Reconfirmation

Performed the measurement in 3-1 again, to reconfirm the number of particles in the measurement system.

4. Measurement results

● Cleanroom specification

Jig Cylinder (no suction from dust collection port)

Particle generation over 1 million operations (CS-CDA16 \times 30)

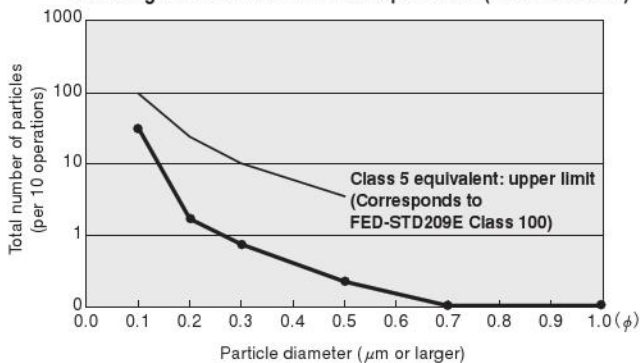

● Cleanroom specification

Slim Cylinder (with suction from dust collection port)

Particle generation over 1 million operations (CS-DA20 \times 100)

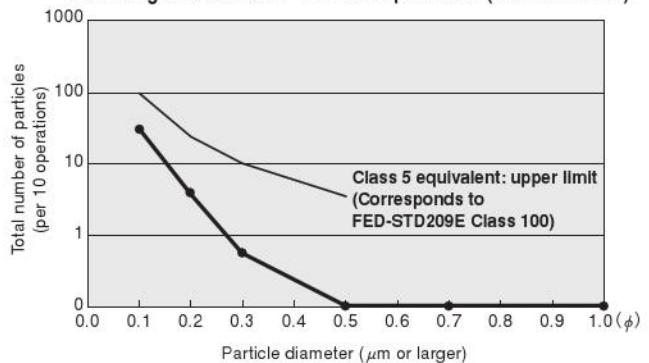

For "safety precautions" listed in the Clean System Product Drawings, see the materials below.

- For actuators, see "Safety Precautions" on p. 45 of the Actuators General Catalog .
- For valves, see "Safety Precautions" on p. 31 of the Valves General Catalog.
- For air treatment and auxiliary equipment, see "Safety Precautions" on p.31 of the General Catalog of Air Treatment, Auxiliary, Vacuum.

Symbol

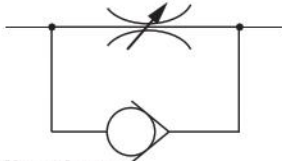

Specifications

Item		Model	CS-TSCO	CS-TSCO-L	CS-TSCO-UC	CS-TSCO-UL
Piping type	Controlled flow P		Female thread		Universal male thread	
	Controlled flow A		Female thread			
Port size			M3×0.5			
Media			Air			
Operating pressure range		MPa [psi.]	0~0.7 [0~102]			
Proof pressure		MPa [psi.]	1.03 [149]			
Cracking pressure		MPa [psi.]	0.05 [7]			
Operating temperature range		°C [°F]	5~60 [41~140]			
Mass		g [oz.]	5 [0.18]	4 [0.14]	6 [0.21]	6 [0.21]

Inner Construction and Major Parts

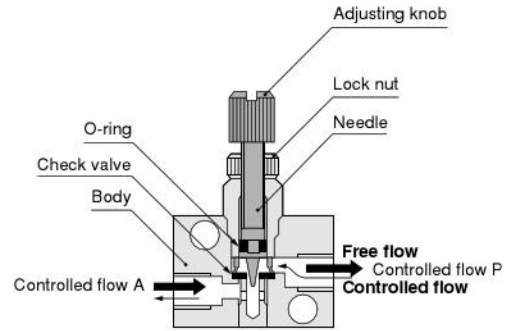

Flow Rate Characteristics

● **Controlled flow**

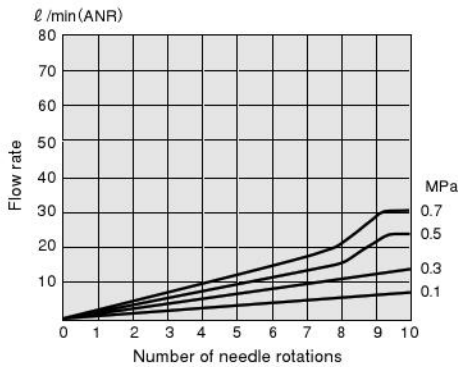

● **Free flow**

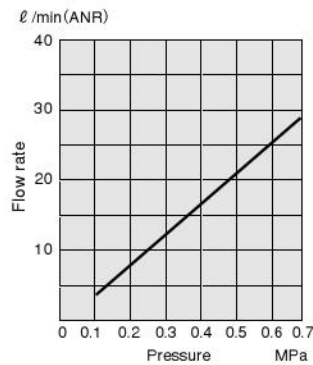

Major Parts and Materials

Parts	Materials
Body	Brass (nickel electroplated)
Needle	Stainless steel
Lock nut	Brass (nickel electroplated)
Check valve	Synthetic rubber (NBR)
O-ring	
Adjusting knob	Brass (nickel electroplated)

1MPa = 145psi. 1 l/min = 0.0353ft³/min.

Dimensions mm [in.]

● **CS-TSCO**

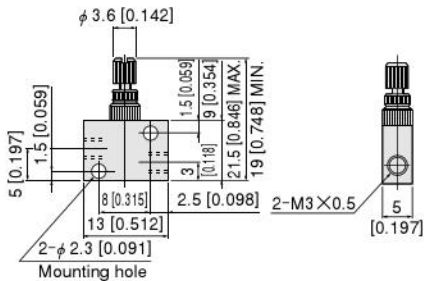

● **CS-TSCO-L**

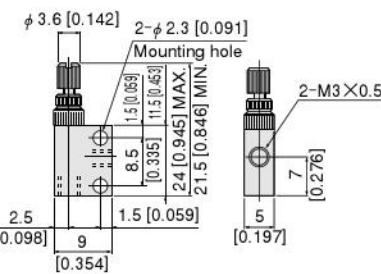

● **CS-TSCO-UC**

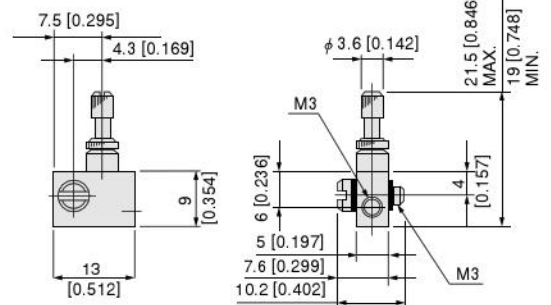

● **CS-TSCO-UL**

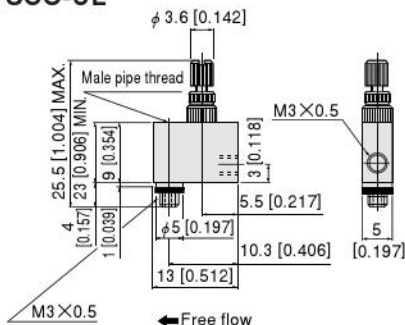

Handling Instructions and Precautions

- Always use fingertips to rotate and tighten the lock nut and needle. Use of excessive tightening force with tools, etc., could cause damage to the parts.
- When using a universal male thread type, secure by tightening the male pipe thread for piping. The tightening torque should be 0.5N·m [4.4in·lbf] or less.