

Koganei Clean System products provide complete support for the maintenance of a clean environment inside the cleanroom.

Koganei Clean System products meet the needs of the ultra-clean production environment. In everything from actuators and valves to air preparation and auxiliary equipment, anti-corrosion materials processing and other Koganei-developed design concepts serve to prevent particle contamination within the cleanroom. These perfectly designed mechanisms, which resolve even the slightest leaks to the outside during operations, have already won a high level of reliability.

Koganei Cleanliness

There is currently no standard in JIS or elsewhere for methods of evaluating cleanliness for pneumatic equipment in the cleanroom specifications. Therefore, to measure the effects of cleanroom contamination by pneumatic equipment, Koganei has decided to use "number of particles generated per 10 operations," rather than particle density. Koganei has also developed classifications for application classes in cleanroom, based on JIS and other upper limit density tables, and on the company's own experience.

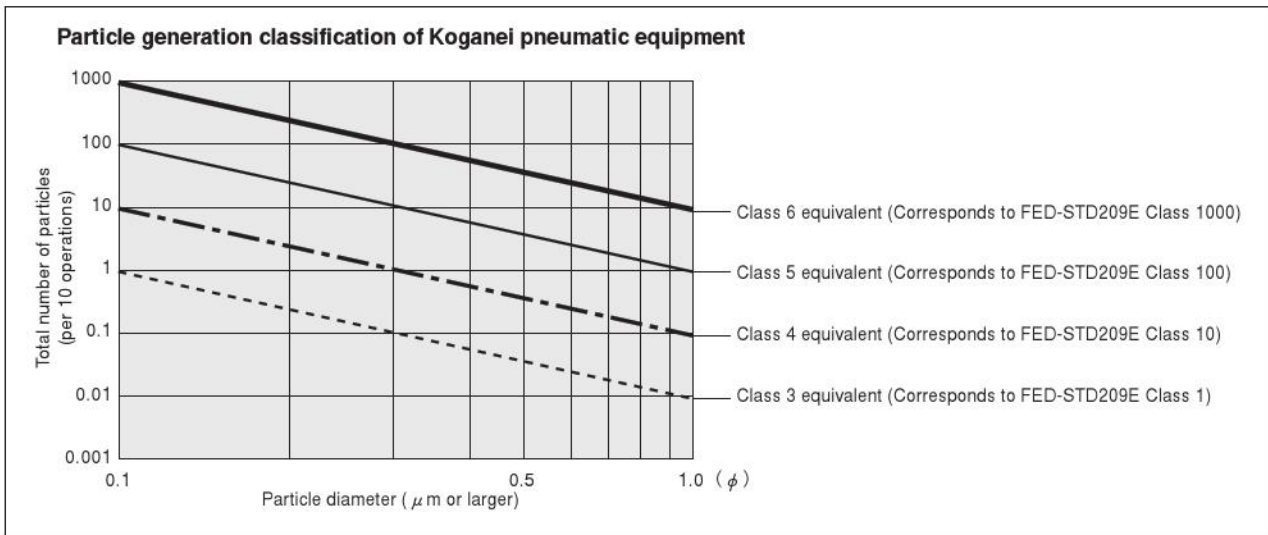

- Remarks:
1. In the above table, product performance in terms of the number of particles generated per 10 operations is expressed as the upper limit of particles corresponding to the equivalent JIS or ISO class.
 2. In the above table, values in the JIS, ISO, and FED-STD upper limit density tables are calculated as upper density per liter.
 3. The classes shown are clean levels as classified in JIS and ISO.

From the above definitions, the Koganei clean level classes can be viewed as the level of average contamination per liter of surrounding air over a period of 10 operations in cleanroom. Air ventilation in cleanrooms is usually faster than 1 cycle per minute, and clean volumetric capacity is usually larger than 1 liter, which should provide a sufficient safety margin in practice.

Caution: The above conclusions are based on an ideal situation in which air ventilation is being implemented. For specific cases where air ventilation is not ensured, caution is needed since the clean classes cannot be maintained.

The clean system diagrams shown here are for Class 5 equivalent products. For Class 4 or Class 3 equivalent products, consult us.

Evaluations of Cleanliness

Koganei has therefore specified its in-house measurement methods, to conduct evaluations on the cleanroom rating.

The number of particles of the Air Cylinder Cleanroom Specification is measured as shown in the method below.

1. Measurement conditions

1-1 Test circuit: Figure 1 (no suction), Figure 2 (with suction)

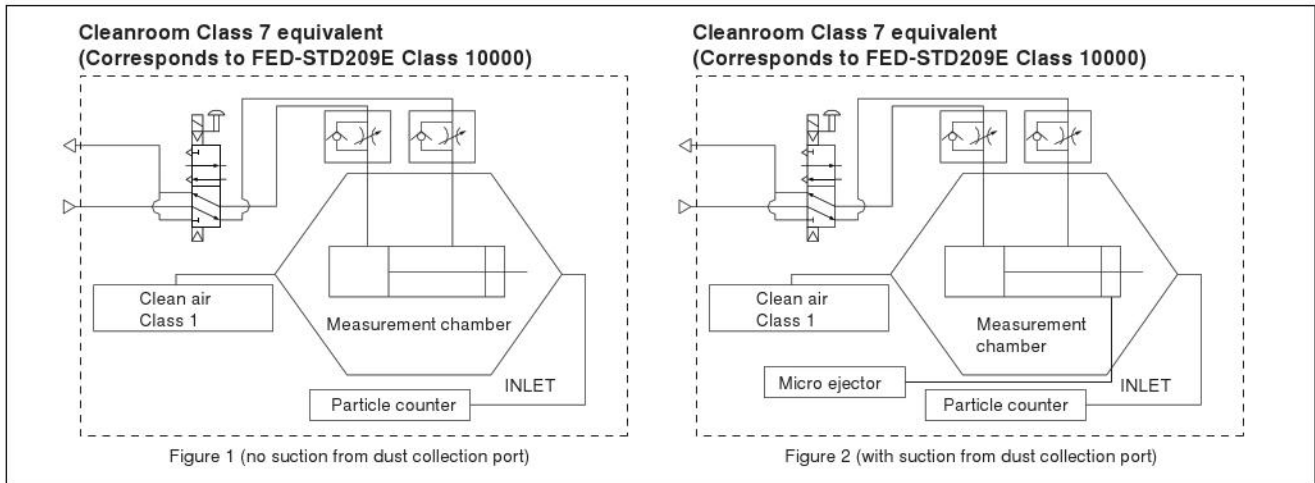

1-2 Operating conditions of tested cylinder

Operating frequency: 1Hz

Average speed: 500mm/s [20in./sec.]

Applied pressure: 0.5MPa [73psi.]

Suction condition: Microejector ME05, Primary side: 0.5MPa [73psi.] applied, Tube: $\phi 6$ [0.236in.]

Mounting direction: Vertical

Chamber volume: 8.3 ℓ [0.293ft³]

2. Particle counter

Manufacturer/model: RION/KM20

Suction flow rate: 28.3 ℓ /min [1ft³/min.]

Particle diameter: 0.1 μm , 0.2 μm , 0.3 μm , 0.5 μm , 0.7 μm , 1.0 μm

3. Measurement method

3-1 Confirmation of number of particles in the measurement system

Under the conditions in the above 1 and 2, using a particle counter to measure the sample for 9 minutes without operating the measurement sample, and confirmed the measured number of particle is 1 piece or less.

3-2 Measurement under operation

Under the conditions in the above 1 and 2, operating the measurement sample for 36 minutes, and measured the total values in the latter half of 18 minutes test.

3-3 Reconfirmation

Performed the measurement in 3-1 again, to reconfirm the number of particles in the measurement system.

4. Measurement results

● Cleanroom specification

Jig Cylinder (no suction from dust collection port)

Particle generation over 1 million operations (CS-CDA16 \times 30)

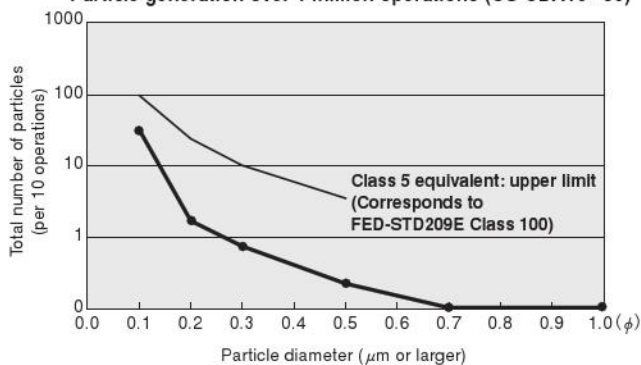

● Cleanroom specification

Slim Cylinder (with suction from dust collection port)

Particle generation over 1 million operations (CS-DA20 \times 100)

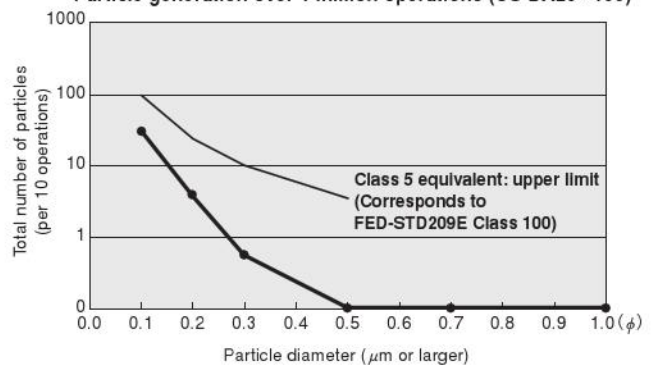

For "safety precautions" listed in the Clean System Product Drawings, see the materials below.

- For actuators, see "Safety Precautions" on p. 45 of the Actuators General Catalog .
- For valves, see "Safety Precautions" on p. 31 of the Valves General Catalog.
- For air treatment and auxiliary equipment, see "Safety Precautions" on p.31 of the General Catalog of Air Treatment, Auxiliary, Vacuum.

KOGANEI CLEAN SYSTEM PEN CYLINDERS



Symbols

- Double acting type
- Single acting push type

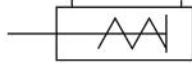
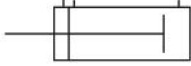

Specifications

Item	Bore mm [in.]	6 [0.236]	10 [0.394]	16 [0.630]
Operating type		Double acting type, Single acting push type		
Media		Air		
Mounting type		Basic type, Foot type, Flange type, Clevis type (clevis type of ϕ 10 and ϕ 16 only)		
Operating pressure range MPa [psi.]	Double acting type	0.15~0.7 [22~102]	0.1~0.7 [15~102]	
	Single acting push type	0.3~0.7 [44~102]	0.15~0.7 [22~102]	
Proof pressure	MPa [psi.]	1.03 [149]		
Operating temperature range	$^{\circ}$ C [$^{\circ}$ F]	0~60 [32~140]		
Operating speed range	mm/s [in./sec.]	50~300 [2.0~11.8]		
Cushion		None	Rubber bumper	
Lubrication		Not required		
Port size		M5 \times 0.8 <small>Note</small>		

Note: M3 \times 0.5 can also be selected at ϕ 6 only.

Bore Size and Stroke

● Double acting type				mm [in.]
Bore size	Standard strokes <small>Note</small>	Maximum available stroke	Stroke tolerance	
6 [0.236]	5, 10, 15, 20, 25, 30, 35, 40, 45, 50, 55, 60	100	+1.5 0 -0.059	
10 [0.394]	5, 10, 15, 20, 25, 30, 35, 40, 45, 50, 55, 60 75, 100, 125, 150	150		
16 [0.630]	5, 10, 15, 20, 25, 30, 35, 40, 45, 50, 55, 60 75, 100, 125, 150, 175, 200	200		

● Single acting type				mm [in.]
Operating type	Bore size	Standard strokes <small>Note</small>	Maximum available stroke	Stroke tolerance
Single acting push type	6 [0.236]	5, 10, 15, 20, 25, 30,	75	+1.5 0 -0.059
	10 [0.394]	35, 40, 45, 50, 55, 60	105	
	16 [0.630]		120	

Note: The non-standard strokes:

For strokes divisible by 5, cylinder tube cutting is used.

For strokes not divisible by 5, a collar is packed to the next size up stroke of cylinder tube.

Order Codes

CS — Clean system product

PB — Pen cylinder series

10 \times 30 — Bore size \times Stroke

Cylinder specification
Blank — Standard cylinder
S — Cylinder with magnet

Operating type
DA — Double acting type
SA — Single acting push type

Number of sensor switches
1 — With 1 sensor switch
2 — With 2 sensor switches
3 — With 3 sensor switches
 ...
 ...

Lead wire length
A — 1000mm [39in.]
B — 3000mm [118in.]

Sensor switch
Blank — Without sensor switch
ZC253 — 3-lead wire, solid state type
ZC230 — 2-lead wire, solid state type
ZC201 — 2-lead wire, reed switch type
ZC205 — 2-lead wire, reed switch type
 ● For details, see p.111~121.

Mounting type (Included at shipping other than clevis mounting type)
Blank — Basic type
1 — Double foot mounting type (mountable only on ϕ 10 and ϕ 16 of head cover -M specification double acting type and -M specification single acting push type)
1A — Single foot mounting type
3 — Flange mounting type
7 — Clevis mounting type (with pin for bore sizes of ϕ 10 and ϕ 16 only)
7-7C — Clevis mounting type with pin and clevis supporting bracket (for bore sizes of ϕ 10 and ϕ 16 only)

Head cover piping specification
Blank — Axial direction piping
A — Lateral piping*
M — Lateral piping with mounting thread*

Connection port
Blank — M5 \times 0.8 (ϕ 6, ϕ 10, ϕ 16)
M3 — M3 \times 0.5 (ϕ 6 only)

* (-A and -M correspond only to ϕ 10 and ϕ 16 of double acting type and single acting push type. Not available for clevis mounting type.)

Order Codes for Mounting Brackets Only

Name	Bore size mm [in.]		
	6 [0.236]	10 [0.394]	16 [0.630]
Single foot bracket	CS-1A-PBDA6	CS-1A-PBDA10	CS-1A-PBDA16
Double foot bracket	CS-1-PBDA6	CS-1-PBDA10	CS-1-PBDA16
Flange bracket	CS-3-PBDA6	CS-3-PBDA10	CS-3-PBDA16
Clevis supporting bracket	—	CS-7C-PBDA10	CS-7C-PBDA16

Mounting type

Mounting type	Name	Remarks
1	Double foot type	Included at shipping
1A	Single foot type ^{Note}	Included at shipping
3	Flange type	Included at shipping
7	Clevis type (with pin)	Assembled and shipped
7-7C	Clevis type with supporting bracket (with pin)	Supporting bracket included at shipping

Note: When the stroke exceeds 60mm [2.362in.], select the double foot type when using the foot bracket.

Mass

Operating type	Mounting type	Bore mm	Stroke mm																	Additional mass				Additional mass of Lateral piping		
																				Mounting type			Cylinder with magnet		Sensor switch (1 pc. ^{Note 2})	
			5	10	15	20	25	30	35	40	45	50	55	60	75	100	125	150	175	200	Single foot	Flange				Clevis ^{Note 1}
Double acting type	Basic type	6	18.8 [0.663]	19.4 [0.684]	20 [0.705]	20.8 [0.734]	21.4 [0.755]	22 [0.776]	22.4 [0.790]	22.8 [0.804]	23 [0.811]	23.6 [0.832]	24.2 [0.854]	25 [0.882]	—	—	—	—	—	7 [0.25]	5 [0.18]	—	0.5 [0.018]	A : 20 [0.71] B : 50 [1.76]	—	
		10	27 [0.952]	28 [0.988]	29 [1.023]	30 [1.058]	31 [1.093]	32 [1.129]	33.3 [1.175]	34.6 [1.220]	36 [1.270]	37 [1.305]	38 [1.340]	39 [1.376]	42.4 [1.496]	48.1 [1.697]	53.8 [1.898]	59.5 [2.099]	—	—	7 [0.25]	5 [0.18]	—		1 [0.04]	2 [0.07]
		16	47.8 [1.686]	49.4 [1.743]	51 [1.799]	52.6 [1.855]	54.2 [1.912]	56 [1.975]	57.6 [2.032]	59.2 [2.088]	61 [2.152]	62.3 [2.198]	63.6 [2.243]	66 [2.328]	71.3 [2.515]	80.1 [2.825]	88.9 [3.136]	97.7 [3.446]	106.5 [3.757]	115.3 [4.067]	18 [0.63]	12 [0.42]	—		2 [0.07]	3 [0.11]
	Clevis mounting type (with pin)	10	30.8 [1.086]	31.9 [1.125]	33 [1.164]	33.8 [1.192]	34.9 [1.231]	36 [1.270]	37.8 [1.333]	38.9 [1.372]	40 [1.411]	40.8 [1.439]	41.9 [1.478]	43 [1.517]	46.3 [1.633]	51.8 [1.827]	57.3 [2.021]	62.8 [2.215]	—	—	—	—	32 [1.13]		1 [0.04]	—
		16	59.4 [2.095]	61.2 [2.159]	63 [2.222]	64.4 [2.272]	66.2 [2.335]	68 [2.399]	69.4 [2.448]	71.2 [2.511]	73 [2.575]	74.4 [2.624]	76.2 [2.688]	78 [2.751]	83.4 [2.942]	92.4 [3.259]	101.4 [3.577]	110.4 [3.894]	119.4 [4.212]	128.4 [4.529]	—	—	45 [1.59]		2 [0.07]	—
		6	15.8 [0.557]	16.4 [0.578]	17 [0.600]	19.8 [0.698]	20.4 [0.720]	21 [0.741]	22.8 [0.804]	23.4 [0.825]	24 [0.847]	24.8 [0.875]	25.4 [0.896]	26 [0.917]	—	—	—	—	—	—	7 [0.25]	5 [0.18]	—		0.5 [0.018]	—
Single acting push type	Basic type	10	26.8 [0.945]	27.9 [0.984]	29 [1.023]	31.8 [1.122]	34 [1.160]	39.8 [1.199]	40.9 [1.404]	42 [1.443]	42.8 [1.481]	43.9 [1.510]	45 [1.549]	48 [1.587]	—	—	—	—	—	—	18 [0.63]	12 [0.42]	—	1 [0.04]	2 [0.07]	
		16	50.4 [1.778]	52.2 [1.841]	54 [1.905]	58.4 [2.060]	60.2 [2.123]	62 [2.187]	72.4 [2.554]	74.2 [2.617]	76 [2.681]	77.4 [2.730]	79.2 [2.794]	81 [2.857]	—	—	—	—	—	—	18 [0.63]	12 [0.42]	—	2 [0.07]	3 [0.11]	
		6	15.8 [0.557]	16.4 [0.578]	17 [0.600]	19.8 [0.698]	20.4 [0.720]	21 [0.741]	22.8 [0.804]	23.4 [0.825]	24 [0.847]	24.8 [0.875]	25.4 [0.896]	26 [0.917]	—	—	—	—	—	—	7 [0.25]	5 [0.18]	—	0.5 [0.018]	—	
	Clevis mounting type (with pin)	10	29.8 [1.051]	30.9 [1.090]	32 [1.129]	34.8 [1.228]	35.9 [1.266]	37 [1.305]	42.8 [1.510]	43.9 [1.549]	45 [1.587]	45.8 [1.616]	46.9 [1.654]	48 [1.693]	—	—	—	—	—	—	—	—	32 [1.13]	1 [0.04]	—	
		16	61.4 [2.166]	63.2 [2.229]	65 [2.293]	69.4 [2.448]	71.2 [2.511]	73 [2.575]	83.4 [2.942]	83.4 [2.942]	87 [3.069]	88.4 [3.118]	90.2 [3.182]	92 [3.245]	—	—	—	—	—	—	—	—	45 [1.59]	2 [0.07]	—	
		6	15.8 [0.557]	16.4 [0.578]	17 [0.600]	19.8 [0.698]	20.4 [0.720]	21 [0.741]	22.8 [0.804]	23.4 [0.825]	24 [0.847]	24.8 [0.875]	25.4 [0.896]	26 [0.917]	—	—	—	—	—	—	7 [0.25]	5 [0.18]	—	0.5 [0.018]	—	

Remark : Includes mounting nut and rod end nut. The clevis mounting type does not include mounting nut.

For the mass of the double foot bracket, add double the mass of the single foot bracket listed above.

Notes: 1. With supporting bracket and pin.

2. Same for all sensor switch models (ZC253□, ZC230□, ZC201□, ZC205□).

Calculation example: The mass for 2 units of ZC253A, with a double acting cylinder with magnet with single foot bracket, bore size of 10mm, and stroke of 45mm, is $36 + 7 + 1 + 40 = 84\text{g}$ [2.96oz.].

Inner Construction (cannot be disassembled)

● Double acting type

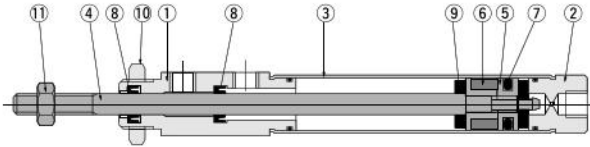

● Single acting push type

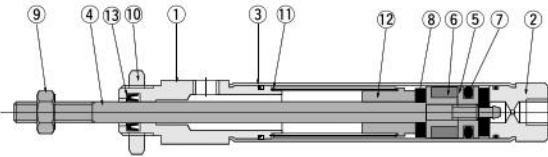

Major Parts and Materials

No.	Parts	Materials
①	Rod cover	Aluminum alloy (nickel plated)
②	Head cover	
③	Cylinder tube	Stainless steel
④	Piston rod	
⑤	Piston	Aluminum alloy
⑥	Magnet ^{Note}	Plastic magnet
⑦	Piston seal	Synthetic rubber (NBR)
⑧	Rod seal	
⑨	Bumper	Urethane rubber
⑩	Mounting nut	Mild steel (nickel plated)
⑪	Rod end nut	

Note: For cylinders with magnets. Standard cylinders do not have a built-in magnet for the sensor switch.

No.	Parts	Materials
①	Rod cover	Aluminum alloy (nickel plated)
②	Head cover	
③	Cylinder tube	Stainless steel
④	Piston rod	
⑤	Piston	Aluminum alloy
⑥	Magnet ^{Note1}	Plastic magnet
⑦	Piston seal	Synthetic rubber (NBR)
⑧	Bumper	Urethane rubber
⑨	Rod end nut	Mild steel (nickel plated)
⑩	Mounting nut	
⑪	Spring	Steel
⑫	Collar	Aluminum alloy
⑬	Rod seal	Synthetic rubber (NBR)

Note: For cylinders with magnets. Standard cylinders do not have a built-in magnet for the sensor switch.

Dimensions of Double Acting Cylinder mm [in.]

Basic type CS - PBDA Bore size Stroke

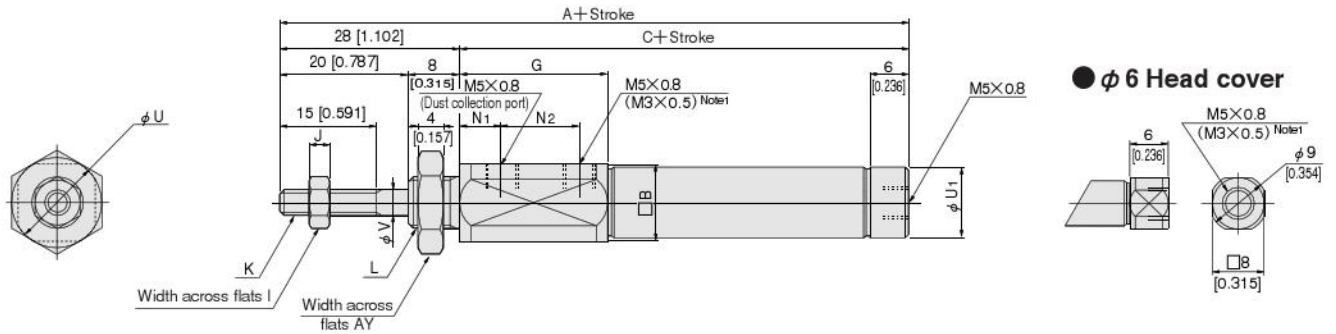

Lateral piping (-A) Note 2

CS - PBDA Bore size Stroke -A

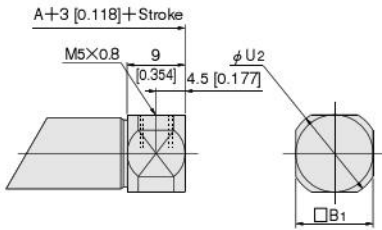

Lateral piping with mounting thread (-M) Note 2

CS - PBDA Bore size Stroke -M

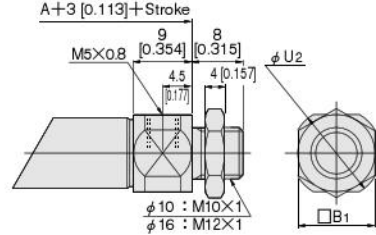

Bore size	Code	A	C	B	B ₁	G	I	J	K	L	N ₁	N ₂	U	U ₁	U ₂	V	AY
6 [0.236]	87 [3.425]	59 [2.323]	12 [0.472]	—	24.5 [0.965]	5.5 [0.217]	2.4 [0.094]	M3×0.5	M8×1	10 [0.394]	10 [0.394]	14 [0.551]	—	—	3 [0.118]	12 [0.472]	
10 [0.394]	81 [3.189]	53 [2.087]	12 [0.472]	12 [0.472]	23 [0.906]	7 [0.276]	3.2 [0.126]	M4×0.7	M10×1	6.5 [0.256]	12 [0.472]	14 [0.551]	11 [0.433]	14 [0.551]	4 [0.157]	14 [0.551]	
16 [0.630]	81.5 [3.209]	53.5 [2.106]	17 [0.669]	17 [0.669]	21.5 [0.846]	8 [0.315]	4 [0.157]	M5×0.8	M12×1	5 [0.197]	12 [0.472]	19 [0.748]	17 [0.669]	19 [0.748]	5 [0.197]	17 [0.669]	

Notes: 1. For bore size $\phi 6$ only.
2. Not available for bore size $\phi 6$.

Clevis mounting type CS - PBDA Bore size Stroke -7

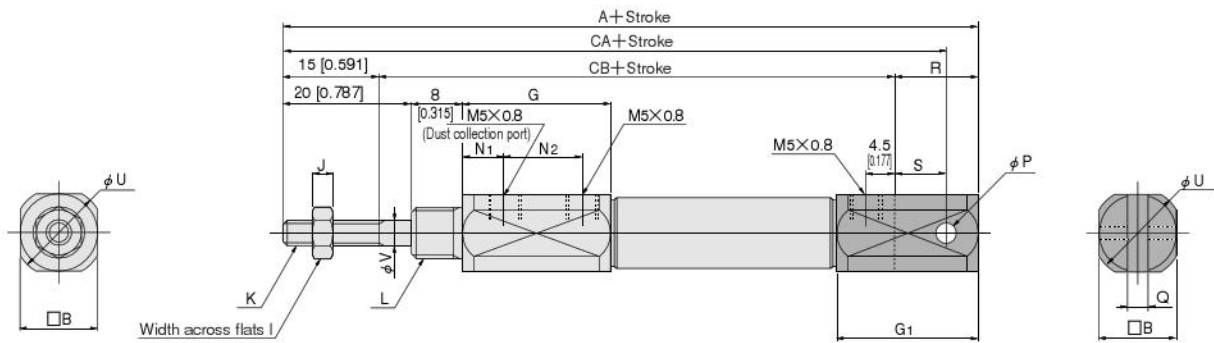

Bore size	Code	A	B	G	G ₁	I	J	K	L	N ₁	N ₂
10 [0.394]	97 [3.819]	12 [0.472]	23 [0.905]	22 [0.866]	7 [0.276]	3.2 [0.126]	M4×0.7	M10×1	6.5 [0.256]	12 [0.472]	
16 [0.630]	102.5 [4.035]	17 [0.669]	21.5 [0.846]	27 [1.063]	8 [0.315]	4 [0.157]	M5×0.8	M12×1	5 [0.197]	12 [0.472]	

Bore size	Code	P	Q	R	S	U	V	CA	CB
10 [0.394]	3.2 ^{+0.09} _{-0.06} [0.1260 ^{+0.0035} _{-0.0024}]	3.2 ^{+0.2} _{-0.1} [0.126 ^{+0.008} _{-0.004}]	13 [0.512]	8 [0.315]	14 [0.551]	4 [0.157]	92 [3.622]	69 [2.717]	
16 [0.630]	5 ^{+0.09} _{-0.06} [0.1969 ^{+0.0035} _{-0.0024}]	6.5 ^{+0.2} _{-0.1} [0.256 ^{+0.008} _{-0.004}]	18 [0.709]	10 [0.394]	19 [0.748]	5 [0.197]	94.5 [3.720]	69.5 [2.736]	

Dimensions of Single Acting Push Type Cylinder mm [in.]

● Basic type CS - PBSA Bore size × Stroke

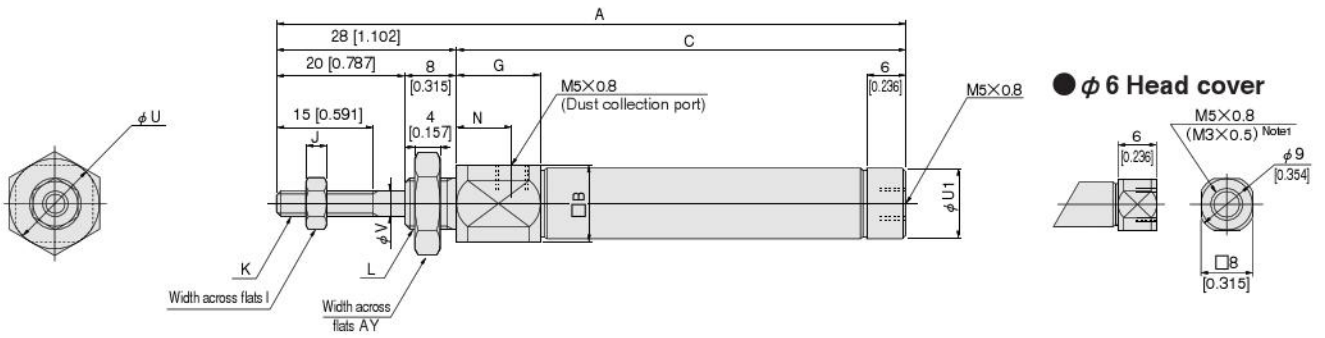

● Lateral piping (-A) Note 2

CS - PBSA Bore size × Stroke -A

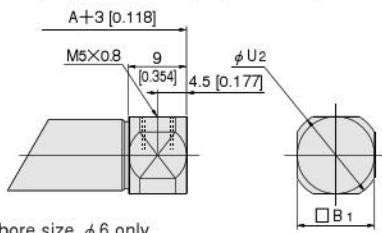

● Lateral piping with mounting thread (-M) Note 2

CS - PBSA Bore size × Stroke -M

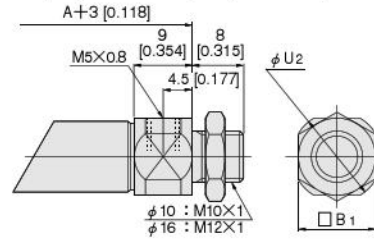

Notes: 1. For bore size φ 6 only.
2. Not available for bore size φ 6.

Code	A												C											
	5	10	15	20	25	30	35	40	45	50	55	60	5	10	15	20	25	30	35	40	45	50	55	60
6 [0.236]	87 [3.425]	92 [3.622]	97 [3.819]	107 [4.213]	112 [4.409]	117 [4.606]	137 [5.394]	142 [5.591]	147 [5.787]	152 [5.984]	157 [6.181]	162 [6.378]	59 [2.323]	64 [2.520]	69 [2.717]	79 [3.110]	84 [3.307]	89 [3.504]	109 [4.291]	114 [4.488]	119 [4.685]	124 [4.882]	129 [5.079]	134 [5.276]
10 [0.394]	86 [3.386]	91 [3.583]	96 [3.780]	106 [4.173]	111 [4.370]	116 [4.567]	131 [5.157]	136 [5.354]	141 [5.551]	146 [5.748]	151 [5.945]	156 [6.142]	58 [2.283]	63 [2.480]	68 [2.677]	78 [3.071]	83 [3.268]	88 [3.465]	103 [4.055]	108 [4.252]	113 [4.449]	118 [4.646]	123 [4.843]	128 [5.039]
16 [0.630]	86.5 [3.406]	91.5 [3.602]	96.5 [3.799]	106.5 [4.193]	111.5 [4.390]	116.5 [4.587]	131.5 [5.177]	136.5 [5.374]	141.5 [5.571]	146.5 [5.768]	151.5 [5.965]	156.5 [6.161]	58.5 [2.303]	63.5 [2.500]	68.5 [2.697]	78.5 [3.091]	83.5 [3.287]	88.5 [3.484]	103.5 [4.075]	108.5 [4.272]	113.5 [4.469]	118.5 [4.665]	123.5 [4.862]	128.5 [5.059]

Code	B	B ₁	G	I	J	K	L	N	U	U ₁	U ₂	V	AY
	6 [0.236]	12 [0.472]	—	14.5 [0.571]	5.5 [0.217]	2.4 [0.094]	M3×0.5	M8×1	8 [0.315]	14 [0.551]	—	—	3 [0.118]
10 [0.394]	12 [0.472]	12 [0.472]	13 [0.512]	7 [0.276]	3.2 [0.126]	M4×0.7	M10×1	8.5 [0.335]	14 [0.551]	11 [0.433]	14 [0.551]	4 [0.157]	14 [0.551]
16 [0.630]	17 [0.669]	17 [0.669]	11.5 [0.453]	8 [0.315]	4 [0.157]	M5×0.8	M12×1	7 [0.276]	19 [0.748]	17 [0.669]	19 [0.748]	5 [0.197]	17 [0.669]

Dimensions of Single Acting Push Type Cylinder mm [in.]

● Clevis mounting type CS - PBSA Bore size × Stroke -7

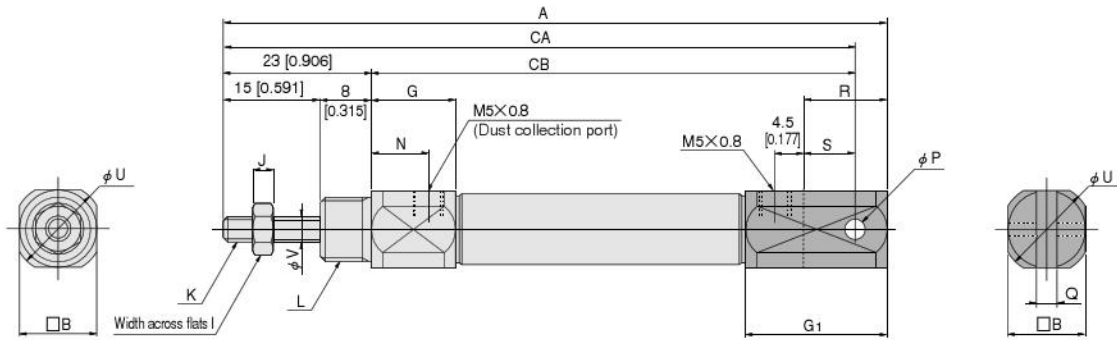

Code		A											
Bore size	Stroke	5	10	15	20	25	30	35	40	45	50	55	60
10 [0.394]		97 [3.819]	102 [4.016]	107 [4.213]	117 [4.606]	122 [4.803]	127 [5.000]	142 [5.591]	147 [5.787]	152 [5.984]	157 [6.181]	162 [6.378]	167 [6.575]
16 [0.630]		102.5 [4.035]	107.5 [4.232]	112.5 [4.429]	122.5 [4.823]	127.5 [5.020]	132.5 [5.217]	147.5 [5.807]	152.5 [6.004]	157.5 [6.201]	162.5 [6.398]	167.5 [6.594]	172.5 [6.791]

Code		CA											
Bore size	Stroke	5	10	15	20	25	30	35	40	45	50	55	60
10 [0.394]		92 [3.622]	97 [3.819]	102 [4.016]	112 [4.409]	117 [4.606]	122 [4.803]	137 [5.394]	142 [5.591]	147 [5.787]	152 [5.984]	157 [6.181]	162 [6.378]
16 [0.630]		94.5 [3.720]	99.5 [3.917]	104.5 [4.114]	114.5 [4.508]	119.5 [4.705]	124.5 [4.902]	139.5 [5.492]	144.5 [5.689]	149.5 [5.886]	154.5 [6.083]	159.5 [6.280]	164.5 [6.476]

Code		CB											
Bore size	Stroke	5	10	15	20	25	30	35	40	45	50	55	60
10 [0.394]		69 [2.717]	74 [2.913]	79 [3.110]	89 [3.504]	94 [3.701]	99 [3.898]	114 [4.488]	119 [4.685]	124 [4.882]	129 [5.079]	134 [5.276]	139 [5.472]
16 [0.630]		71.5 [2.815]	76.5 [3.012]	81.5 [3.209]	91.5 [3.602]	96.5 [3.799]	101.5 [3.996]	116.5 [4.587]	121.5 [4.783]	126.5 [4.980]	131.5 [5.177]	136.5 [5.374]	141.5 [5.571]

Bore size	Code	B	G	G ₁	I	J	K	L	N	P	Q	R	S	U	V
10 [0.394]		12 [0.472]	13 [0.512]	22 [0.866]	7 [0.276]	3.2 [0.126]	M4×0.7	M10×1	8.5 [0.335]	3.2 ^{+0.09} _{-0.06} [0.1260 ^{+0.0035} _{-0.0021}]	3.2 ^{+0.2} _{-0.1} [0.126 ^{+0.008} _{-0.004}]	13 [0.512]	8 [0.315]	14 [0.551]	4 [0.157]
16 [0.630]		17 [0.669]	11.5 [0.453]	27 [1.063]	8 [0.315]	4 [0.157]	M5×0.8	M12×1	7 [0.276]	5 ^{+0.08} _{-0.08} [0.1969 ^{+0.0035} _{-0.0021}]	6.5 ^{+0.2} _{-0.1} [0.256 ^{+0.008} _{-0.004}]	18 [0.709]	10 [0.394]	19 [0.748]	5 [0.197]

PEN CYLINDERS

Sensor Switches

Symbol



Order Codes for Sensor Switches

● Sensor switches (with mounting band)

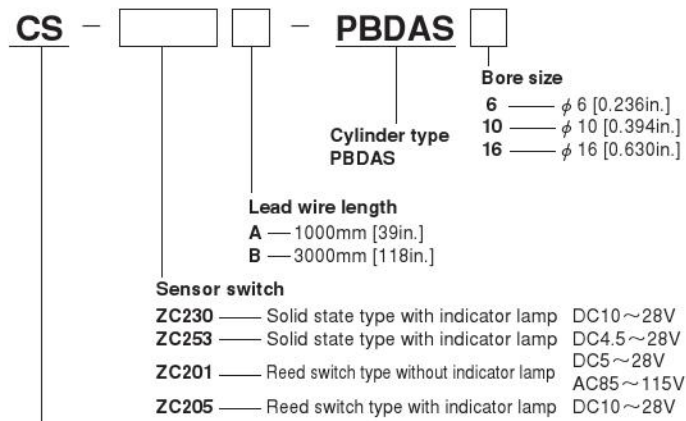

● Mounting band only

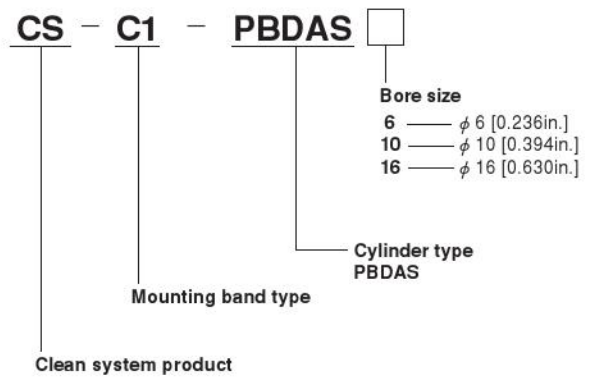

● For details of sensor switches, see p.111~121.

Minimum Cylinder Strokes When Mounting Sensor Switches

Depending on the sensor switch type and quantity, as well as on the mounting position, the minimum cylinder strokes that allow sensor switch mounting are shown below.

● Two pieces mounting

● When mounted in-line

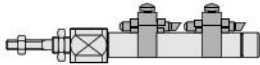

● When mounted in staggered positions

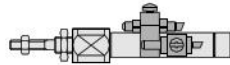

● One piece mounting

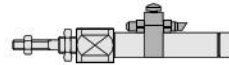

mm [in.]

Sensor switch model	2 pcs. mounting		1 pc. mounting
	In-line	In staggered positions	
ZC230□, ZC253□	30 [1.181]	5 [0.197]	5 [0.197]
ZC201□, ZC205□		10 [0.394]	

Sensor Switch Operating Range, Response Differential, and Maximum Sensing Location

● Operating range: ℓ

The distance the piston travels in one direction, while the switch is in the ON position.

● Response differential: C

The distance between the point where the piston turns the switch ON and the point where the switch is turned OFF as the piston travels in the opposite direction.

mm [in.]

Bore size	ZC230□, ZC253□		ZC201□, ZC205□	
	Operating range	Response differential	Operating range	Response differential
6 [0.236]	1.5~2.5 [0.059~0.098]	0.3 [0.012] or less	4~6 [0.157~0.236]	1.4 [0.055] or less
10 [0.394]	2.0~3.0 [0.079~0.118]	0.3 [0.012] or less	4~6 [0.157~0.236]	1.5 [0.059] or less
16 [0.630]	2.5~3.5 [0.098~0.138]	0.3 [0.012] or less	5~7 [0.197~0.276]	1.8 [0.071] or less

Note: The operating range and response differential are to be used as reference values.

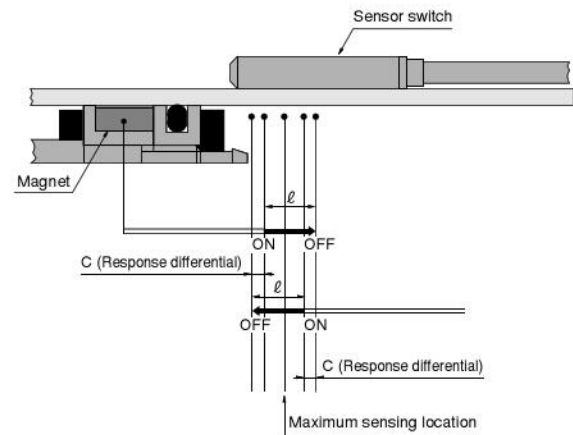

Mounting Location of End of Stroke Detection Sensor Switch

When the sensor switch is mounted in the location shown in the diagram below (figures in the tables are reference values), the magnet comes to the maximum sensing location of the sensor switch at the end of the stroke.

● Double acting type

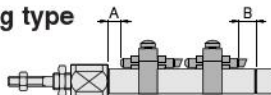

mm [in.]

Sensor switch model	Bore size Code	6 [0.236]	10 [0.394]	16 [0.630]
		ZC230□ ZC253□	A	3.5 [0.138]
	B	0 [0]	-3 [-0.118]	-2 [-0.079]
ZC201□	A	5 [0.197]	3.5 [0.138]	4.5 [0.177]
	B	1.5 [0.059]	-1.5 [-0.059]	-0.5 [-0.020]
ZC205□	A	1.5 [0.059]	0 [0]	1 [0.039]
	B	1 [0.039]	-2 [-0.079]	-1 [-0.039]

● Single acting push type

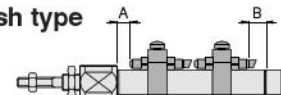

mm [in.]

Sensor switch model	Code	Stroke	Bore size		
			6 [0.236]	10 [0.394]	16 [0.630]
ZC230□ ZC253□	A	0~15	3.5 [0.138]	7 [0.276]	8 [0.315]
		16~30	8.5 [0.335]	12 [0.472]	13 [0.512]
		31~60	23.5 [0.925]	22 [0.866]	23 [0.906]
	B	—	0 [0]	-3 [-0.118]	-2 [-0.079]
ZC201□	A	0~15	5 [0.197]	8.5 [0.335]	9.5 [0.374]
		16~30	10 [0.394]	13.5 [0.531]	14.5 [0.571]
		31~60	25 [0.984]	23.5 [0.925]	24.5 [0.965]
	B	—	1.5 [0.059]	-1.5 [-0.059]	-0.5 [-0.020]
ZC205□	A	0~15	1.5 [0.059]	5 [0.197]	6 [0.236]
		16~30	6.5 [0.256]	10 [0.394]	11 [0.433]
		31~60	21.5 [0.846]	20 [0.787]	21 [0.827]
	B	—	1 [0.039]	-2 [-0.079]	-1 [-0.039]

Mounting Sensor Switch by Strokes

● 5mm stroke

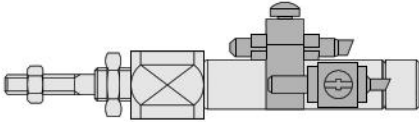

● 10mm stroke

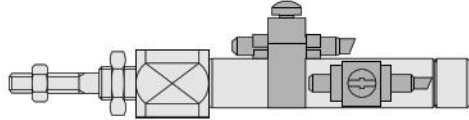

Position of sensor holder, and how to adjust it

- The sensor holder cannot be installed at the center of the sensor switch in the axial direction when mounting 2 sensor switches on a 5mm [0.197in.] stroke cylinder.
- When mounting 2 sensor switches on a 5mm [0.197in.] stroke cylinder, loosen the mounting screw and move the sensor switch until the sensor holder is in the position shown in the diagram, and install it in the prescribed position.
- For 10mm [0.394in.] strokes or longer, install the sensor holder so that it is approximately at the center of the sensor switch in the axial direction, as shown in the diagram.

Moving Sensor Switch

- Loosening the mounting screw allows the sensor switch to be moved either along the axial or circumference direction of the cylinder.
- When making fine adjustments of the sensor switch along the axial direction, a very slight loosening of the mounting screw (about one-half turn) is enough to allow the sensor switch to move.
- Tighten the mounting screw with a tightening torque of 0.3N·m [2.7in·lbf] or less.

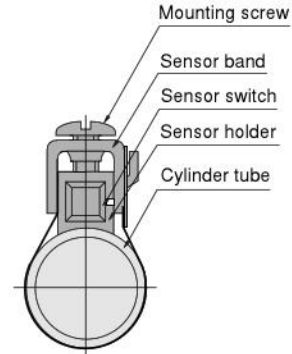

● Caution when installing sensor switches on the cylinder

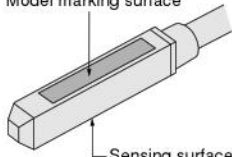

In the ZC type sensor switches, the opposite side from the model marking surface is the sensing surface side. Mount it so that the cylinder magnet comes to the sensing surface side.

Dimensions of Sensor Switch Mounting mm [in.]

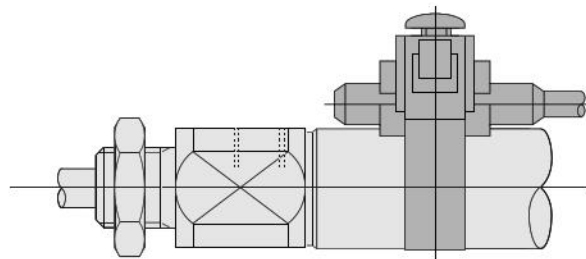
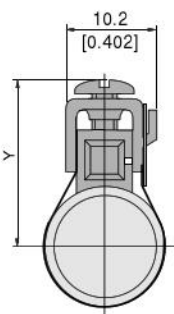

Bore size	Code	Y
6 [0.236]	(16 [0.630])	
10 [0.394]	(18 [0.709])	
16 [0.630]	(21 [0.827])	

PEN CYLINDERS

Mounting Brackets, Rod End Accessories



Dimensions of Mounting Bracket mm [in.]

● Single foot bracket (For the order code, see p. 62.)

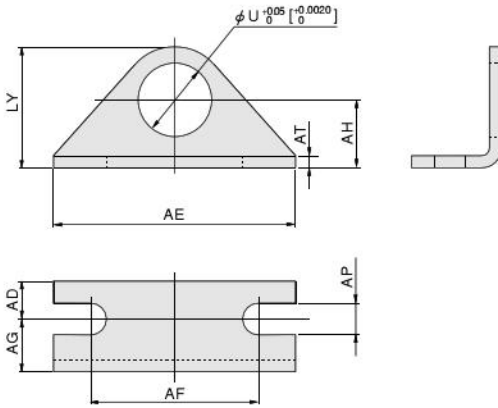

Code Bore size	U	AD	AE	AF	AG	AH	AP	AT	LY
6 [0.236]	8 [0.315]	5 [0.197]	32 [1.260]	22.2 [0.874]	7 [0.276]	9 [0.354]	4.2 [0.165]	1.6 [0.063]	16 [0.630]
10 [0.394]	10 [0.394]	6 [0.236]	42 [1.654]	29.2 [1.150]	9 [0.354]	14 [0.551]	5.2 [0.205]	2.3 [0.091]	24 [0.945]
16 [0.630]	12 [0.472]	6 [0.236]	42 [1.654]	29.2 [1.150]	9 [0.354]	14 [0.551]	5.2 [0.205]	2.3 [0.091]	24 [0.945]

● Flange bracket (For the order code, see p. 62.)

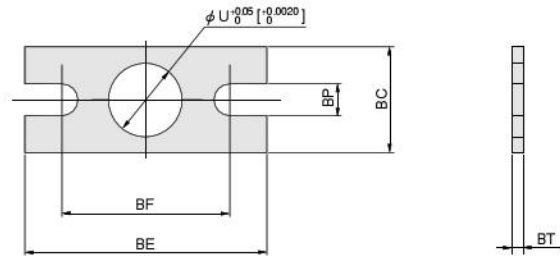

Code Bore size	U	BC	BE	BF	BP	BT
6 [0.236]	8 [0.315]	14 [0.551]	32 [1.260]	22.2 [0.874]	4.2 [0.165]	1.6 [0.063]
10 [0.394]	10 [0.394]	20 [0.787]	42 [1.654]	29.2 [1.150]	5.2 [0.205]	2.3 [0.091]
16 [0.630]	12 [0.472]	20 [0.787]	42 [1.654]	29.2 [1.150]	5.2 [0.205]	2.3 [0.091]

● Clevis mount supporting bracket

Order code: 7C-PBDA Bore size

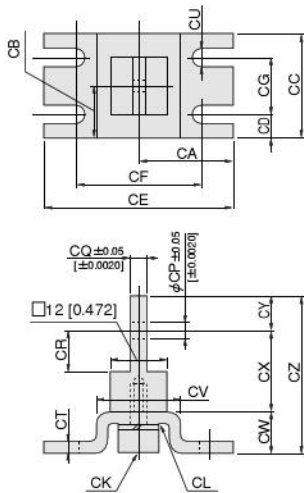

Code Bore size	CA	CB	CC	CD	CE	CF	CG	CK (Hexagon socket head bolt)
10 [0.394]	20 [0.787]	11 [0.433]	22 [0.866]	5 [0.197]	40 [1.575]	30.2 [1.189]	12 [0.472]	M4×0.7×10 [0.394]
16 [0.630]	24 [0.945]	14 [0.551]	28 [1.102]	6 [0.236]	48 [1.890]	35.2 [1.386]	16 [0.630]	M5×0.8×10 [0.394]

Code Bore size	CL (Spring washer)	CP	CQ	CR	CT	CU	CV	CW	CX	CY	CZ
10 [0.394]	Nominal 4 [0.157]	3.3 [0.130]	3.1 [0.122]	9 [0.354]	2 [0.079]	4.2 [0.165]	18 [0.709]	8 [0.315]	21 [0.827]	7 [0.276]	36 [1.417]
16 [0.630]	Nominal 5 [0.197]	5.1 [0.201]	6.4 [0.252]	14 [0.551]	2.3 [0.091]	5.2 [0.205]	20 [0.787]	10 [0.394]	25 [0.984]	7 [0.276]	42 [1.654]

Dimensions of Rod End Accessories mm [in.] Note: Rod end accessories for clean systems are not available.

● Y type knuckle

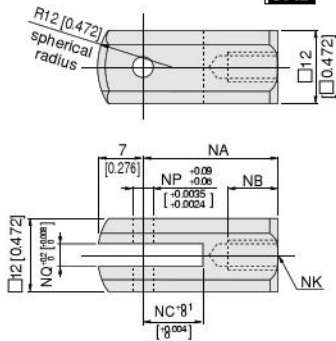

Bore size	Code	NA	NB	NC	NK	NP	NQ	Mass g (with pin)
10 [0.394]	21 [0.827]	8 [0.315]	10 [0.394]	M4×0.7	3.2 [0.126]	3.2 [0.126]	21 [0.827]	
16 [0.630]	21 [0.827]	11 [0.433]	10 [0.394]	M5×0.8	5 [0.197]	6.5 [0.256]	15 [0.591]	

● I type knuckle

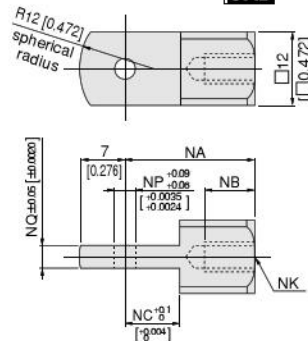

Bore size	Code	NA	NB	NC	NK	NP	NQ	Mass g
10 [0.394]	21 [0.827]	8 [0.315]	9 [0.354]	M4×0.7	3.2 [0.126]	3.1 [0.122]	16 [0.630]	
16 [0.630]	25 [0.984]	8 [0.315]	14 [0.551]	M5×0.8	5 [0.197]	6.4 [0.252]	22 [0.866]	

Dimensions of Pin Bracket mm [in.]

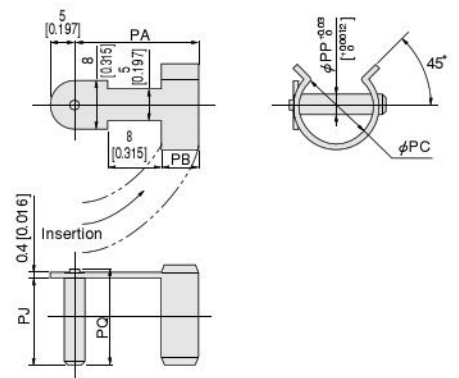

Bore size	Code	PA	PB	PC	PJ	PP	PQ	Mass g
10 [0.394]	17 [0.669]	5 [0.197]	14 [0.551]	13.5 [0.531]	3.2 [0.126]	(15) [0.591]	2 [0.079]	
16 [0.630]	17 [0.669]	5 [0.197]	14 [0.551]	13.5 [0.531]	5	(15) [0.591]	3	
16 [0.630] [※]	19 [0.748]	6 [0.236]	19 [0.748]	19 [0.748]	5 [0.197]	(20.5) [0.807]	3 [0.118]	

Note: ※ shows the case for clevis mounting bracket.

Order Codes for Mounting Brackets and Rod End Accessories

Note: Rod end accessories for clean systems are not available.

(1) Single foot bracket

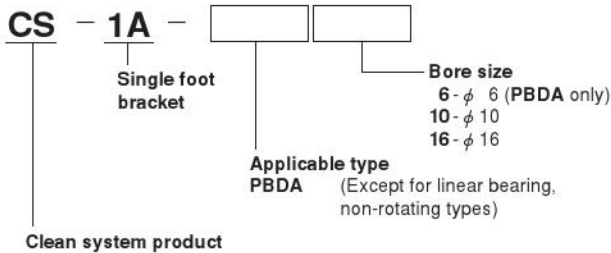

(5) Y type knuckle Note

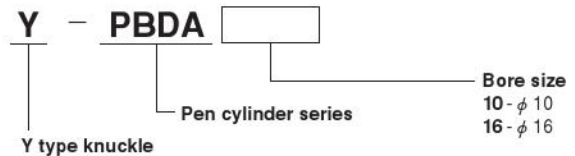

(2) Double foot bracket (2 foot brackets in 1 set)

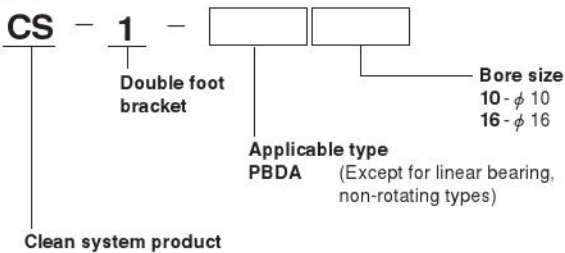

(6) I type knuckle Note

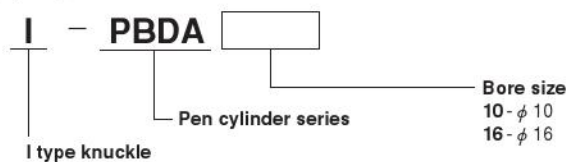

(3) Flange bracket

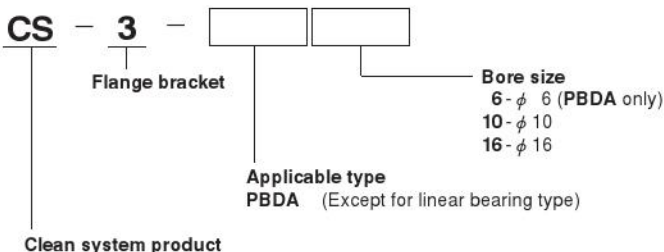

(7) Pin bracket Note

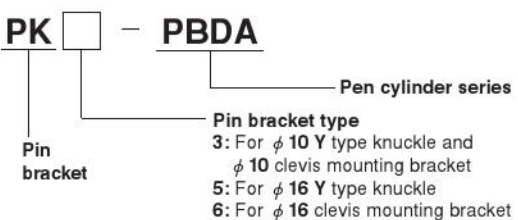

(4) Clevis mount supporting bracket

