

Koganei Clean System products provide complete support for the maintenance of a clean environment inside the cleanroom.

Koganei Clean System products meet the needs of the ultra-clean production environment. In everything from actuators and valves to air preparation and auxiliary equipment, anti-corrosion materials processing and other Koganei-developed design concepts serve to prevent particle contamination within the cleanroom. These perfectly designed mechanisms, which resolve even the slightest leaks to the outside during operations, have already won a high level of reliability.

Koganei Cleanliness

There is currently no standard in JIS or elsewhere for methods of evaluating cleanliness for pneumatic equipment in the cleanroom specifications. Therefore, to measure the effects of cleanroom contamination by pneumatic equipment, Koganei has decided to use “number of particles generated per 10 operations,” rather than particle density. Koganei has also developed classifications for application classes in cleanroom, based on JIS and other upper limit density tables, and on the company’s own experience.

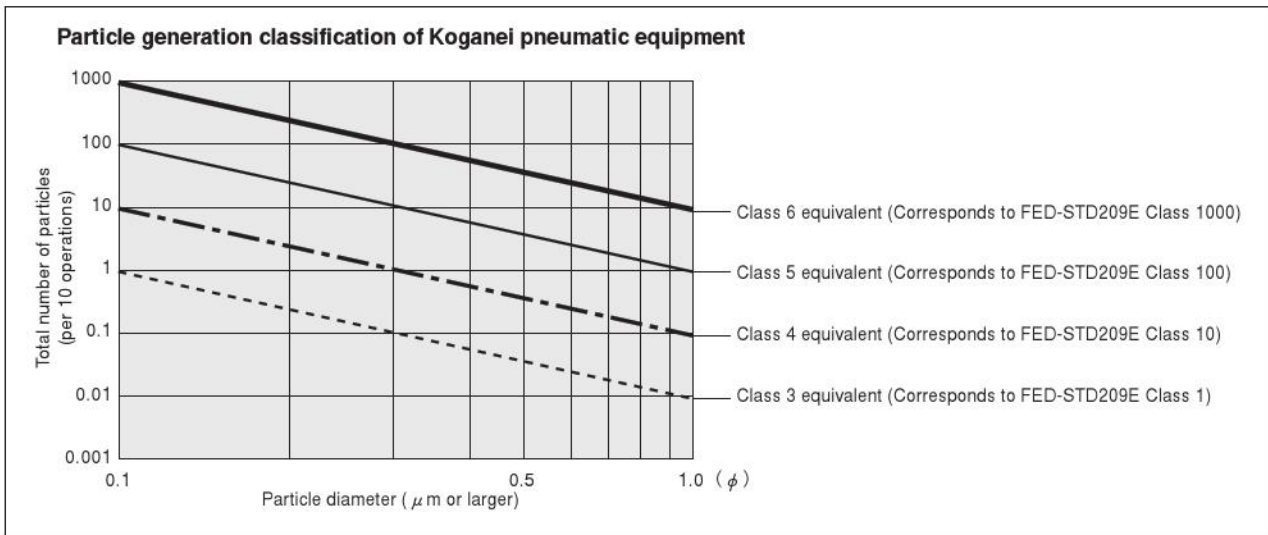

- Remarks:
1. In the above table, product performance in terms of the number of particles generated per 10 operations is expressed as the upper limit of particles corresponding to the equivalent JIS or ISO class.
 2. In the above table, values in the JIS, ISO, and FED-STD upper limit density tables are calculated as upper density per liter.
 3. The classes shown are clean levels as classified in JIS and ISO.

From the above definitions, the Koganei clean level classes can be viewed as the level of average contamination per liter of surrounding air over a period of 10 operations in cleanroom. Air ventilation in cleanrooms is usually faster than 1 cycle per minute, and clean volumetric capacity is usually larger than 1 liter, which should provide a sufficient safety margin in practice.

Caution: The above conclusions are based on an ideal situation in which air ventilation is being implemented. For specific cases where air ventilation is not ensured, caution is needed since the clean classes cannot be maintained.

The clean system diagrams shown here are for Class 5 equivalent products. For Class 4 or Class 3 equivalent products, consult us.

Evaluations of Cleanliness

Koganei has therefore specified its in-house measurement methods, to conduct evaluations on the cleanroom rating.

The number of particles of the Air Cylinder Cleanroom Specification is measured as shown in the method below.

1. Measurement conditions

1-1 Test circuit: Figure 1 (no suction), Figure 2 (with suction)

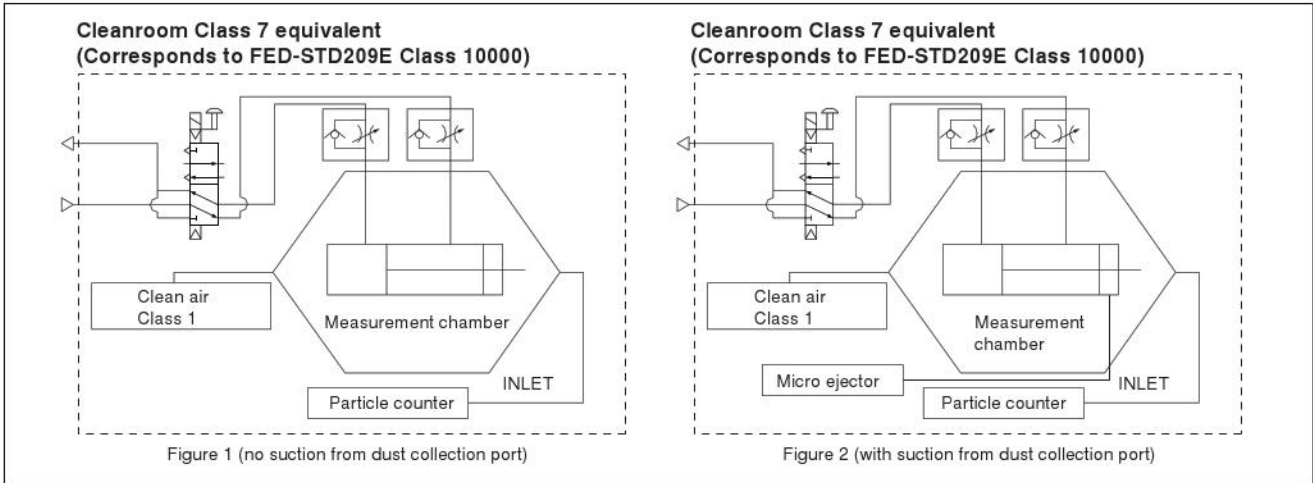

1-2 Operating conditions of tested cylinder

Operating frequency: 1Hz

Average speed: 500mm/s [20in./sec.]

Applied pressure: 0.5MPa [73psi.]

Suction condition: Microejector ME05, Primary side: 0.5MPa [73psi.] applied, Tube: $\phi 6$ [0.236in.]

Mounting direction: Vertical

Chamber volume: 8.3 ℓ [0.293ft³]

2. Particle counter

Manufacturer/model: RION/KM20

Suction flow rate: 28.3 ℓ /min [1ft³/min.]

Particle diameter: 0.1 μm , 0.2 μm , 0.3 μm , 0.5 μm , 0.7 μm , 1.0 μm

3. Measurement method

3-1 Confirmation of number of particles in the measurement system

Under the conditions in the above 1 and 2, using a particle counter to measure the sample for 9 minutes without operating the measurement sample, and confirmed the measured number of particle is 1 piece or less.

3-2 Measurement under operation

Under the conditions in the above 1 and 2, operating the measurement sample for 36 minutes, and measured the total values in the latter half of 18 minutes test.

3-3 Reconfirmation

Performed the measurement in 3-1 again, to reconfirm the number of particles in the measurement system.

4. Measurement results

● Cleanroom specification

Jig Cylinder (no suction from dust collection port)

Particle generation over 1 million operations (CS-CDA16 \times 30)

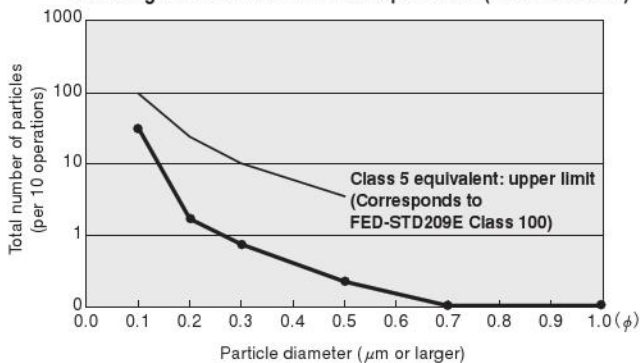

● Cleanroom specification

Slim Cylinder (with suction from dust collection port)

Particle generation over 1 million operations (CS-DA20 \times 100)

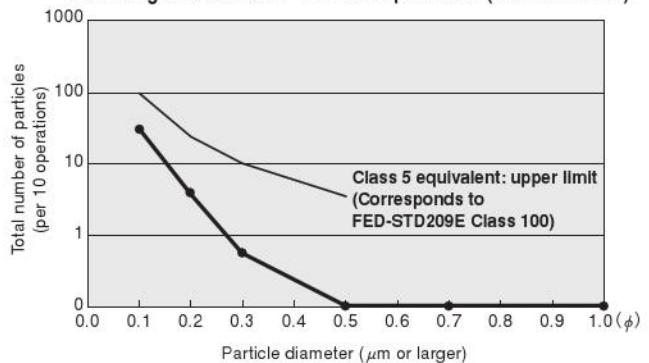

For "safety precautions" listed in the Clean System Product Drawings, see the materials below.

- For actuators, see "Safety Precautions" on p. 45 of the Actuators General Catalog .
- For valves, see "Safety Precautions" on p. 31 of the Valves General Catalog.
- For air treatment and auxiliary equipment, see "Safety Precautions" on p.31 of the General Catalog of Air Treatment, Auxiliary, Vacuum.

KOGANEI CLEAN SYSTEM SOLENOID VALVES 030 SERIES

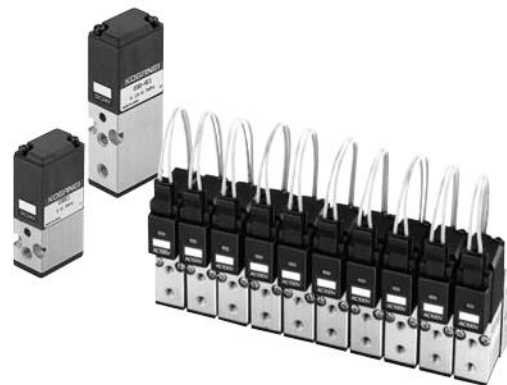

Symbols

2-port Normally closed (NC) 3-port Normally closed (NC) 5-port, 2-position Single solenoid

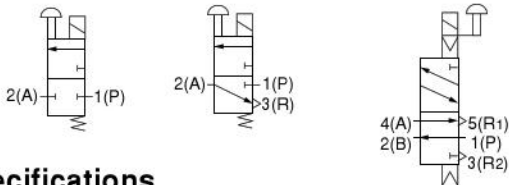

Specifications

Item	Basic model		CS-030E1	CS-030-4E1	CS-V030E1
	For direct piping, T, F, F01 type manifolds				
Number of positions	2 positions				
Number of ports			2, 3 ports	5 ports	2, 3 ports
Valve function			Normally closed (NC)	Single solenoid	Normally closed (NC)
Media	Air			Vacuum	
Operation type			Direct acting type	Internal pilot type	Direct acting type
Effective area [Cv]	mm ²		1(P)→2(A)0.6[0.03] 2(A)→3(R)0.8[0.04]	1(P)→4(A),2(B)0.6[0.03] 4(A)→5(R1), 2(B)→3(R2)0.8[0.04]	1(P)→2(A)0.6[0.03] 2(A)→3(R)0.8[0.04]
Port size ^{Note1}	M5×0.8				
Lubrication	Not required				
Operating pressure range	MPa[psi.]		0~0.7 [0~102]	0.15~0.7 [22~102]	~100kPa~0 [-29.53in.Hg~0]
Proof pressure	MPa[psi.]		1.05 [152]		—
Response time	ms	DC12V, DC24V	10/25 or below		
ON/OFF		AC100V, AC200V	15/40 or below		
Maximum operating frequency	Hz		5		
Operating temperature range (atmosphere and media)	°C [°F]		5~50 [41~122]		
Shock resistance	m/s ² [G]		117.7 [12]		
Mounting direction	Any				

Solenoid Specifications

Item	Rated voltage		DC12V	DC24V	AC100V	AC200V
Type	Flywheel diode incorporated for surge suppression			Shading type		
Operating voltage range	V		10.8~13.2 (12±10%)	21.6~26.4 (24±10%)	90~132 (100±3%)	180~264 (200±3%)
Current (when rated voltage is applied)	Frequency	Hz	—	—	50	60
	Starting	mA (r.m.s.)	—	—	36	32
	Energizing	mA (r.m.s.)	130 (1.6W) [140 (1.7W) with LED indicator]	65 (1.6W) [75 (1.8W) with LED indicator]	24	20
Maximum allowable leakage current	mA		8	4	4	2
Insulation resistance	MΩ		Over 100			
Wiring type and lead wire length	Standard		Grommet type: 300mm [11.8in.]			
	Optional		Plug connector type: 300mm [11.8in.] Note: See made to order on p.151.			
Color of lead wire			Brown (+) Black (-)	Red (+) Black (-)	Yellow	White
Color of LED indicator			Red		Yellow	Green
Surge suppression (as standard)			Flywheel diode		Varistor	

Inner Construction and Major Parts

● 2, 3-port

CS-030E1-24

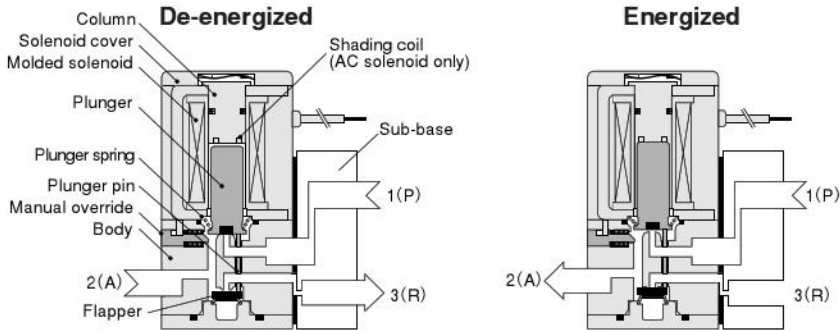

● 5-port

CS-030-4E1-24

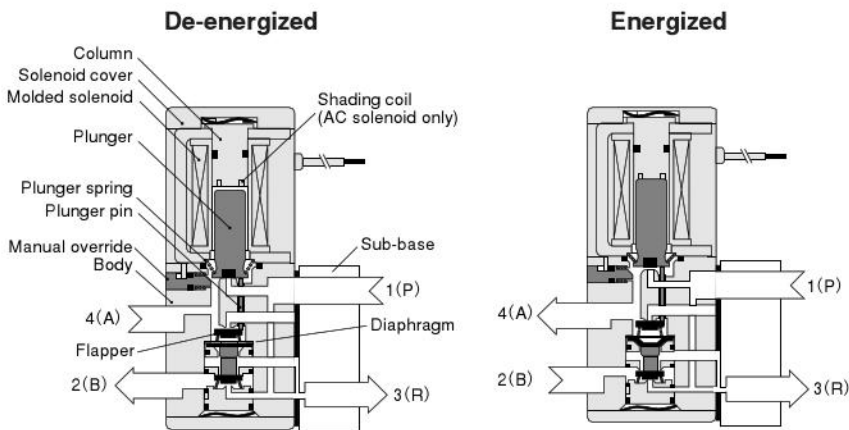

Major Parts and Materials

CS-030E1

Parts	Materials
Body	Aluminum alloy (anodized)
O-ring	Synthetic rubber (NBR)
Flapper	
Plunger	Magnetic stainless steel
Column	
Spring	Stainless steel
Sub-base	Aluminum alloy (anodized)
Mounting base	Mild steel (nickel plated)

CS-030-4E1

Parts	Materials
Body	Aluminum alloy (anodized)
O-ring	Synthetic rubber (NBR)
Flapper	
Diaphragm	Synthetic rubber (urethane)
Plunger	Magnetic stainless steel
Column	
Spring	Stainless steel
Sub-base	Aluminum alloy (anodized)
Mounting base	Mild steel (nickel plated)

Manifold Materials

Parts	Materials
Manifold body	Aluminum alloy (anodized)
Block-off plate	Mild steel (nickel plated)
Bracket	
Seal	Synthetic rubber (NBR)

Order Codes

CS - 030E1						AC100V				
Clean system 030 series valve basic model	Number of ports		Sub-base		Manual override		Solenoid			Voltage
	3-port	2-port	Without sub-base (For manifold)	With sub-base (For single unit)	Non-locking type (Standard)	Locking protruding type	Grommet (Standard)	Straight connector	L connector	
CS - 030E1 2-, 3-port for positive pressure	Blank	- 2	Blank * Cannot be used as a single unit.	- 24	Blank	- 83	Blank	- PSL	- PLL	DC12V DC24V AC100V AC200V
CS - 030 - 4E1 5-port for positive pressure	—									
CS - V030 E1 2-, 3-port for vacuum	Blank	- 2								

Manifold Order Codes

CS - YM					
Clean system 030 series manifold basic model	Number of units	Manifold model		Station	Clean system mounting valve model
		CS-YM	2 : 2 units 3 : 3 units ⋮ 10 : 10 units ⋮ 20 : 20 units ● For 11 or more stations, use F01 only.		

Dimensions of Solenoid Valve mm [in.]

● CS-030E1-24

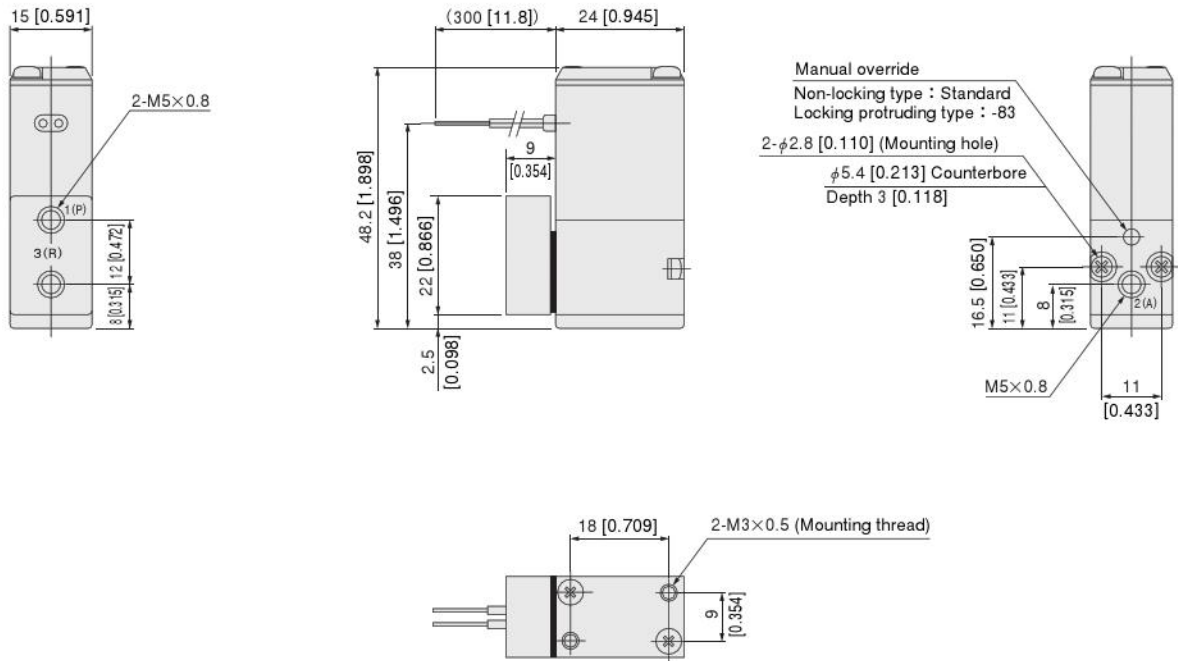

● CS-030-4E1-24

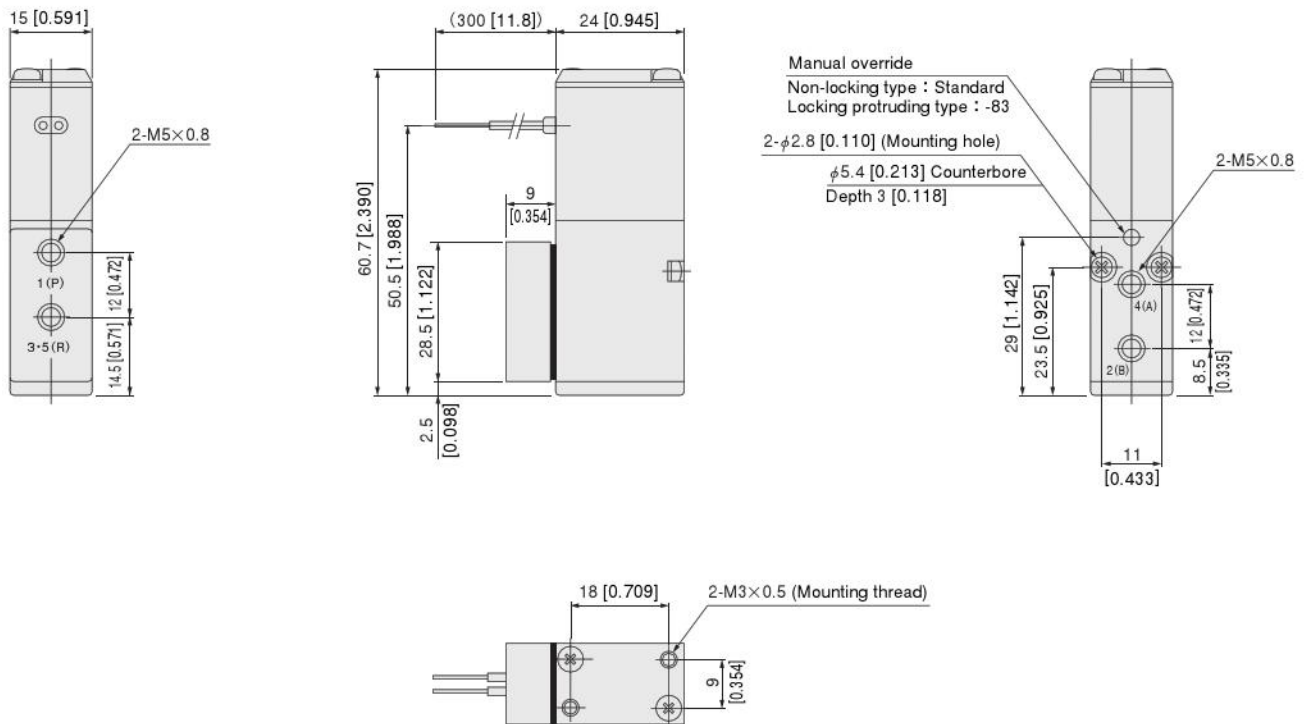

Dimensions of Solenoid Valve mm [in.]

● CS-V030E1-24

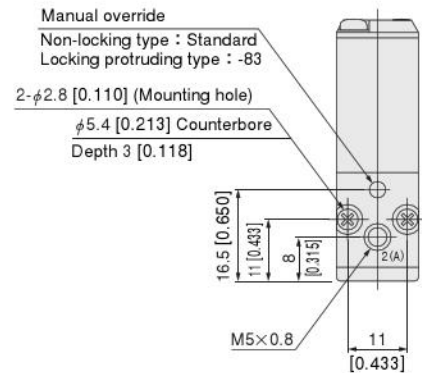
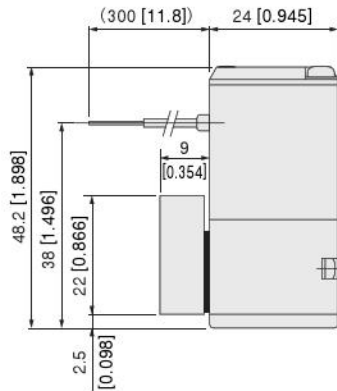
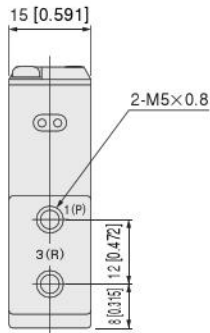

Additional Parts (To be ordered separately)

- Mounting base : 030-21

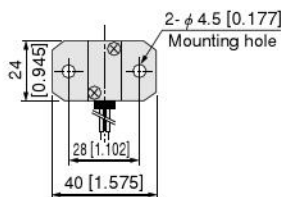
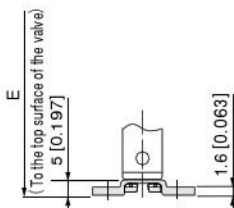

● Options

- Locking protruding type manual override : -83

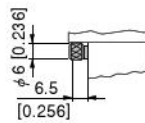

- Solenoid with straight connector : -PSL

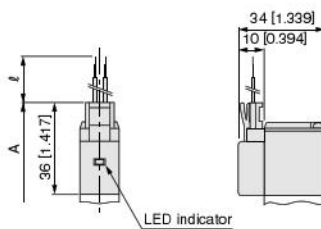

- Solenoid with L connector : -PLL

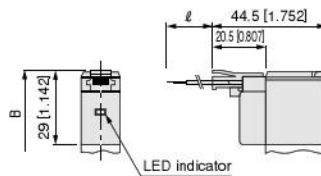

※ The lead wire direction is to the side with the manual override and 4(A), 2(B) port.

● Made to Order

- Solenoid with DIN connector : -39

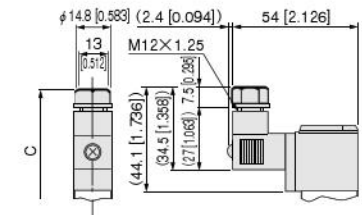

- Solenoid with LED indicator : -L

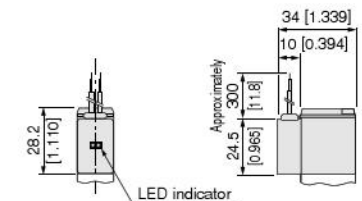

- Built-in interface unit : -FA

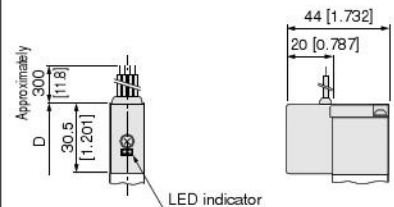

Model	Code	A	B	C	D	E	ℓ (Lead wire length)	Remark
CS-030E1, CS-V030E1		56 [2.205]	49 [1.929]	64.1 [2.524]	50.5 [1.988]	53.2 [2.094]	-PSL, -PLL: 300 [11.8] Made to order: -1L: 1000 [39], -3L: 3000 [118]	Overall length to the end of the valve
CS-030-4E1		68.5 [2.697]	61.5 [2.421]	76.6 [3.016]	63 [2.480]	65.7 [2.587]		

Dimensions of Manifold for 2-, 3-port Valve mm [in.]

●CS-YM□T

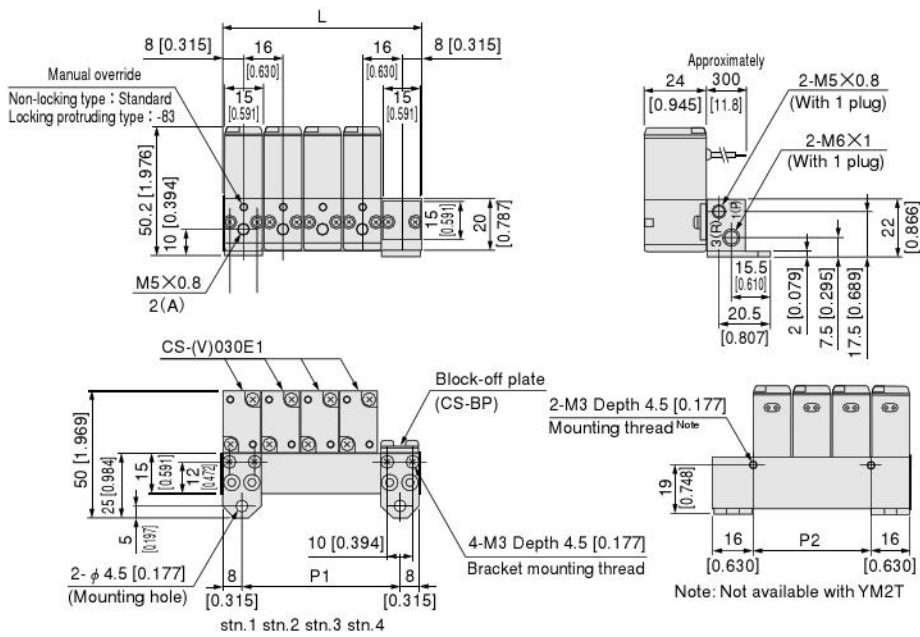

Unit dimensions

Model	L	P1	P2
CS-YM2T	32 [1.260]	16 [0.630]	—
CS-YM3T	48 [1.890]	32 [1.260]	16 [0.630]
CS-YM4T	64 [2.520]	48 [1.890]	32 [1.260]
CS-YM5T	80 [3.150]	64 [2.520]	48 [1.890]
CS-YM6T	96 [3.780]	80 [3.150]	64 [2.520]
CS-YM7T	112 [4.409]	96 [3.780]	80 [3.150]
CS-YM8T	128 [5.039]	112 [4.409]	96 [3.780]
CS-YM9T	144 [5.669]	128 [5.039]	112 [4.409]
CS-YM10T	160 [6.299]	144 [5.669]	128 [5.039]

Manifold for Combination Mounting of 2-, 3-, 5-port Valves mm [in.]

● CS-YM□F

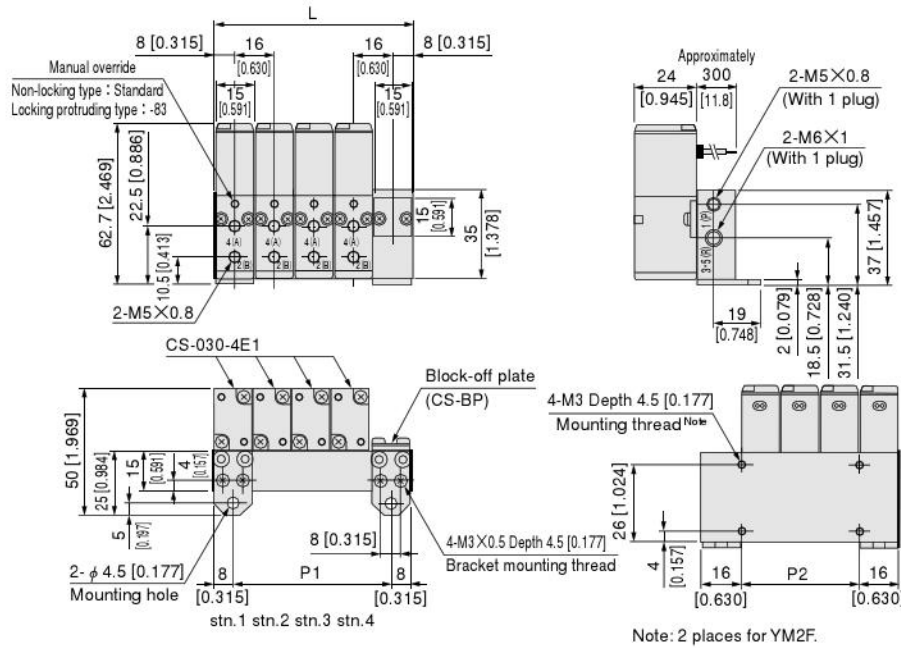

Unit dimensions

Model	L	P1	P2
CS-YM2F	32 [1.260]	16 [0.630]	—
CS-YM3F	48 [1.890]	32 [1.260]	16 [0.630]
CS-YM4F	64 [2.520]	48 [1.890]	32 [1.260]
CS-YM5F	80 [3.150]	64 [2.520]	48 [1.890]
CS-YM6F	96 [3.780]	80 [3.150]	64 [2.520]
CS-YM7F	112 [4.409]	96 [3.780]	80 [3.150]
CS-YM8F	128 [5.039]	112 [4.409]	96 [3.780]
CS-YM9F	144 [5.669]	128 [5.039]	112 [4.409]
CS-YM10F	160 [6.299]	144 [5.669]	128 [5.039]

● CS-YM□F01

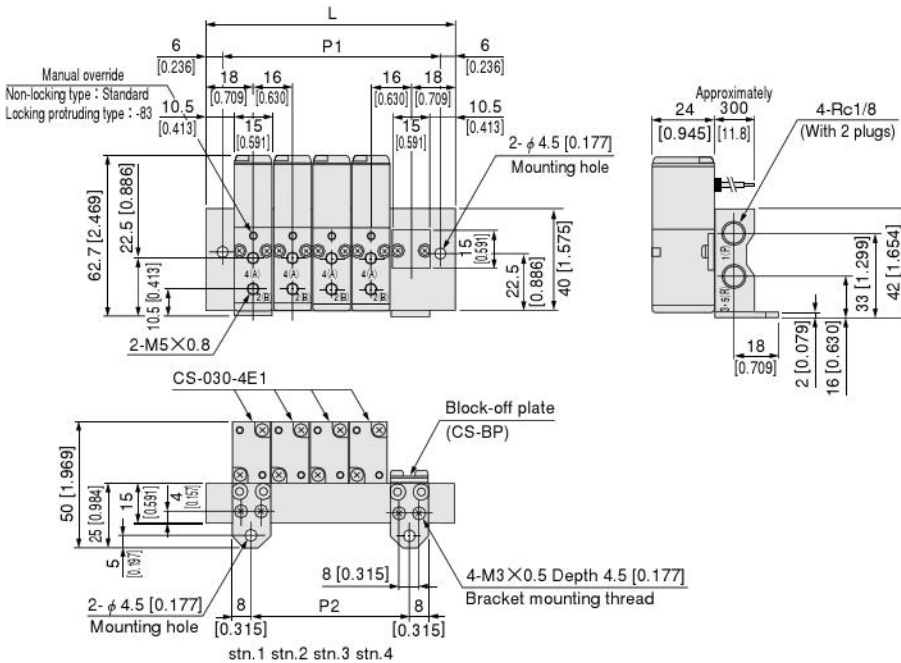

Unit dimensions

Model	L	P1	P2
CS-YM2F01	52 [2.047]	40 [1.575]	16 [0.630]
CS-YM3F01	68 [2.677]	56 [2.205]	32 [1.260]
CS-YM4F01	84 [3.307]	72 [2.835]	48 [1.890]
CS-YM5F01	100 [3.937]	88 [3.465]	64 [2.520]
CS-YM6F01	116 [4.567]	104 [4.094]	80 [3.150]
CS-YM7F01	132 [5.197]	120 [4.724]	96 [3.780]
CS-YM8F01	148 [5.827]	136 [5.354]	112 [4.409]
CS-YM9F01	164 [6.457]	152 [5.984]	128 [5.039]
CS-YM10F01	180 [7.087]	168 [6.614]	144 [5.669]
CS-YM11F01	196 [7.717]	184 [7.244]	160 [6.299]
CS-YM12F01	212 [8.346]	200 [7.874]	176 [6.929]
CS-YM13F01	228 [8.976]	216 [8.504]	192 [7.559]
CS-YM14F01	244 [9.606]	232 [9.134]	208 [8.189]
CS-YM15F01	260 [10.236]	248 [9.764]	224 [8.819]
CS-YM16F01	276 [10.866]	264 [10.394]	240 [9.449]
CS-YM17F01	292 [11.496]	280 [11.024]	256 [10.079]
CS-YM18F01	308 [12.126]	296 [11.654]	272 [10.709]
CS-YM19F01	324 [12.756]	312 [12.283]	288 [11.339]
CS-YM20F01	340 [13.386]	328 [12.913]	304 [11.969]