

Charts for Solenoid Valve Selection

1. Air flow rate of each series (2-, 3-port)

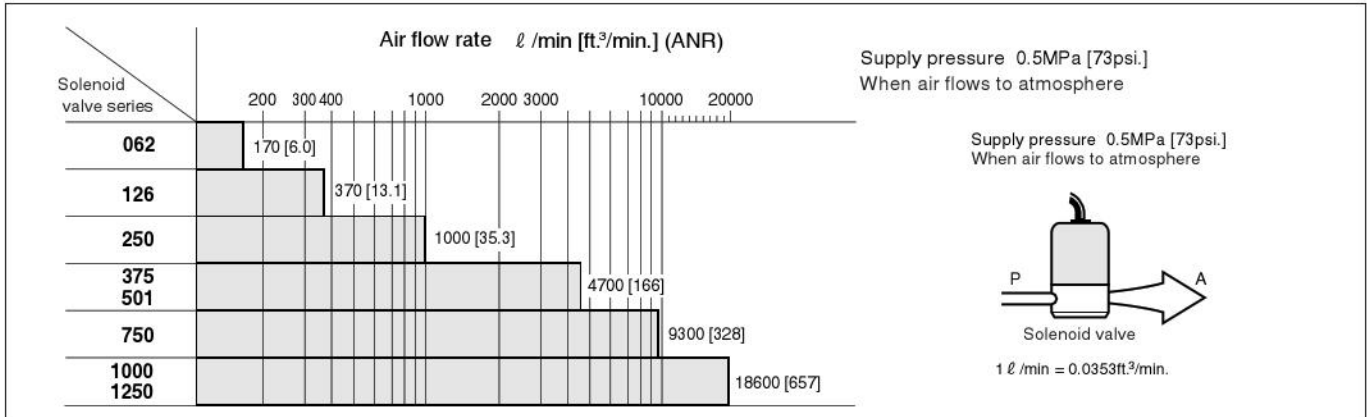

2. Applicable cylinder bore size of each series (4-, 5-port)

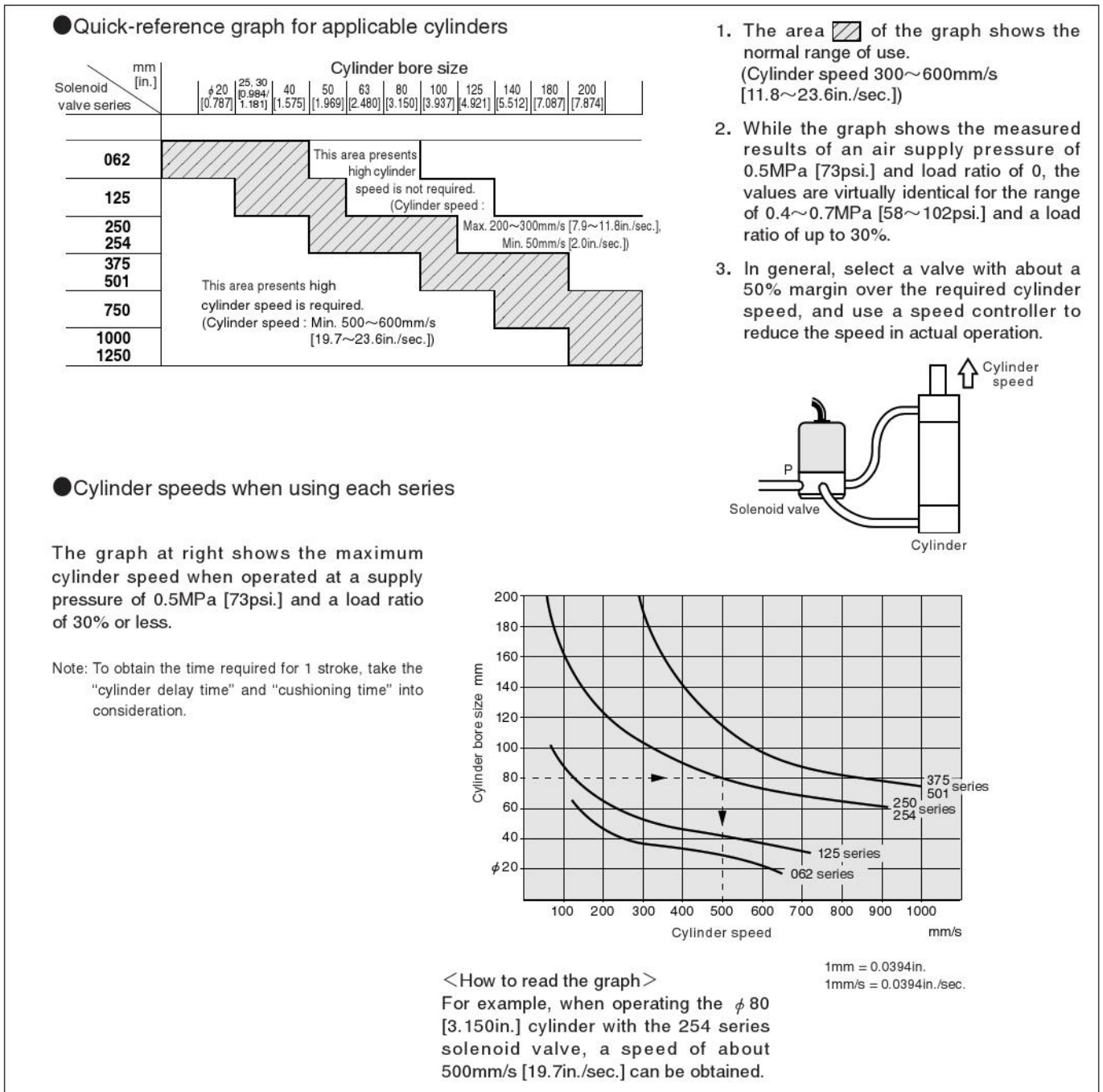

Basic Construction and Features

●The diagram shows an indirect-acting 3-port, normally closed, single solenoid type 501E1

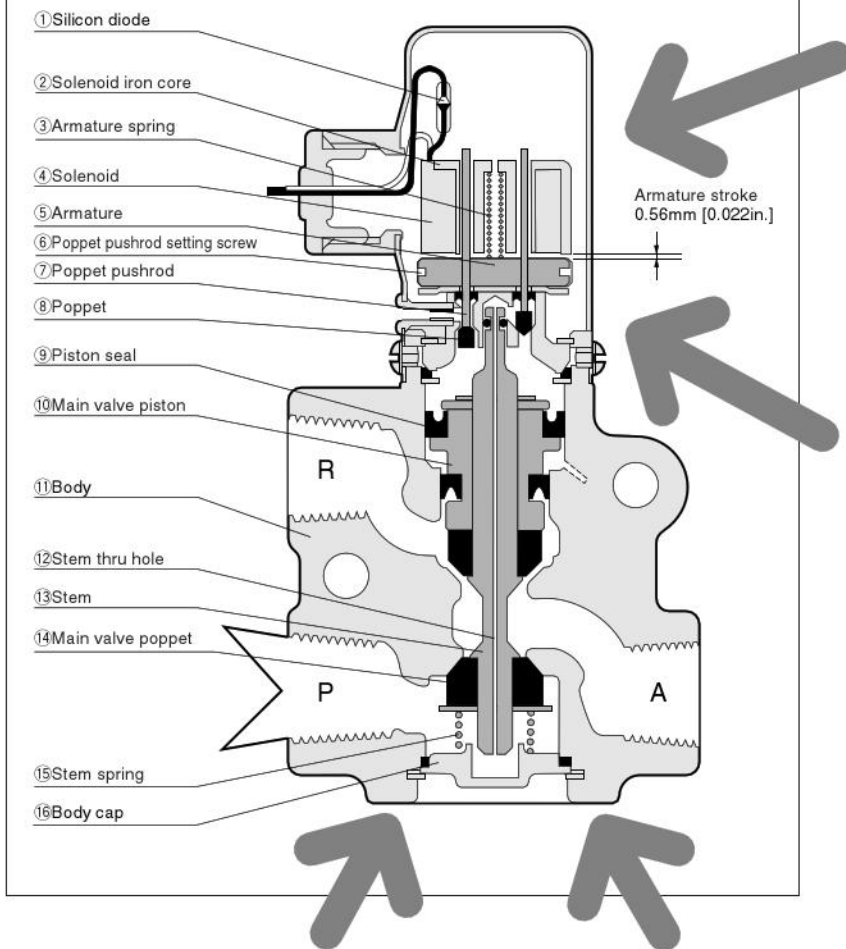

- Small electric current
- No burning failure

The solenoid uses a special construction, with an extremely small 0.56mm [0.022in.] armature stroke, and therefore consumes little electric current.

In addition, the AC type uses a silicon diode for half-wave rectification that ensures extremely stable operation.

Moreover, since there is no in-rush current, the capacity of electrical equipment can be reduced, decreasing the amount of heat generated in high-frequency operations. The coil will not burn even if the armature unactuates under some abnormal situation.

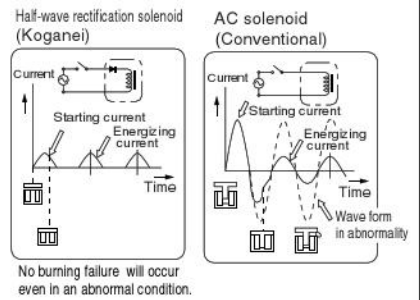

- No solenoid coil wire breaks or damages

The coil is a vacuum epoxy resin impregnated mold, for high resistance to heat, cold, humidity and vibration, and completely eliminates wire-break failure. Moreover, the iron core is not a laminated sheet, but rather machined a single block, for superior mechanical strength against heat or shocks, and endures a long time without deformation or breakage.

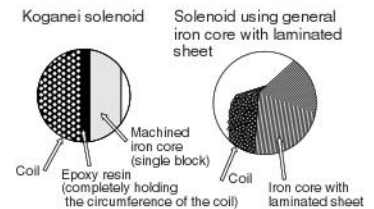

- Compact and light

A poppet construction with unique and compact design. The body is made of light aluminum alloy.

- No sticking

Entering foreign materials into a valve's interior, not using for a long period, etc., could cause the main valve piston to stick. This is not a problem at all with the poppet type round solenoid valves.

- Any mounting direction acceptable

While some valves will require that the mounting direction is vertical or horizontal to operate, the round solenoid valve remains undisturbed regardless of whether the direction is off to some degree, upper or lower, or left or right.

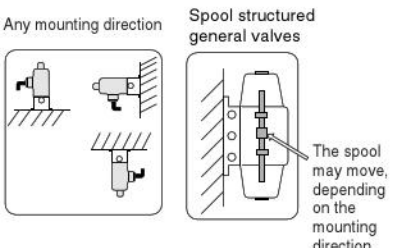

- No need for lubrication

With virtually no sliding parts, there is no need for lubrication except for a few specific models. This means no break-downs, caused by such as galling due to insufficient lubrication. It can also eliminate periodic lubrication expenses.

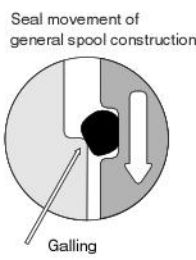

- No leakage due to foreign materials in the media

While foreign materials in the media can often cause leaks, the round solenoid valve uses rubber to absorb the distortions caused by a certain volume of foreign materials to prevent leaks.

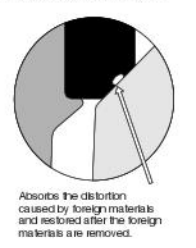

- Can operate in high-frequency applications

The poppet and stem section have low mass and the stroke is short, helping to reduce inertial force, while the synthetic rubber flexibly absorbs impacts, enabling excellent durability in continuous, high-frequency operations.

- Many kinds of voltages, common to each models (Except for explosion proof valves)

While the standard specifications are AC100V and 200V, many other voltages are available, as shown in the appended table. Many of these voltages are common to each model, and therefore offer interchangeability, good quality control and stable quality. All solenoids, including the DC types, have the same shape and same dimensions.

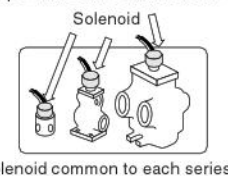

- Extremely long operating life

With virtually no sliding parts, and with the large elastic capacity of the synthetic rubber used in the stem, the high capacity design eliminates any concerns about wear or damage. The operating life is therefore extremely long, and all models except a very few can last over more than 10 million operating cycles.

Solenoid Types and Operating Principles

(While the schematic diagrams show the direct-acting 062 series, 3-port valve, the basic construction of the solenoid is the same for the 4-port valve and for the pilot section of the indirect acting valve.)

Single solenoid type, normally closed

(E1 type, NC)

Symbol

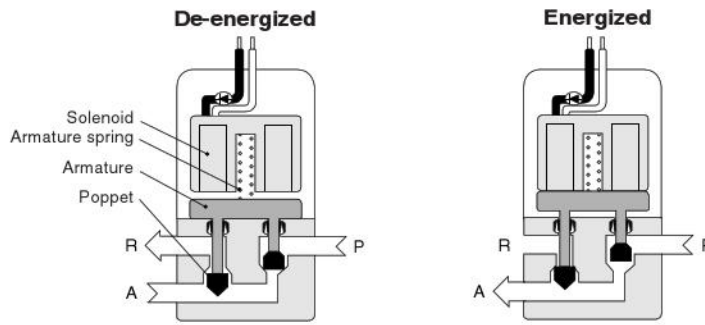
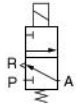

1. When de-energized, air coming through port P is closed by the poppet at P, and air at A goes to port R.
2. When energized, the P side poppet opens and the R side poppet closes, so that the air flows from P to A.
3. When power is cut off, the armature is pushed downward by the armature spring to change the valve to a de-energized condition.

Single solenoid type, normally open

(E1 type, NO)

Symbol

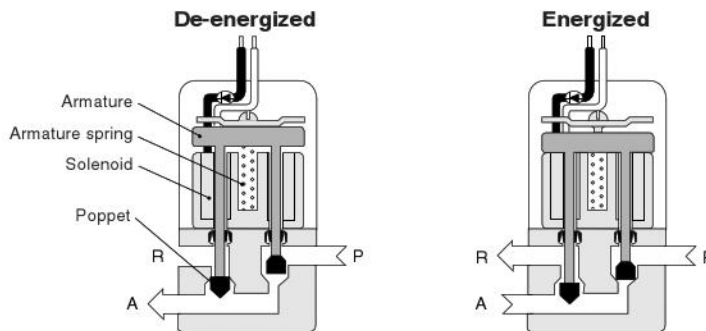
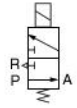

1. When de-energized, the air coming through port P flows to A, but the R side is closed.
2. When energized, the P side poppet closes and the R side poppet opens, so that the air flows from A to R.
3. When power is cut off, the armature is pushed upward by the armature spring to change the valve to a de-energized condition.

Keep solenoid type

(SE2 type)

Symbol

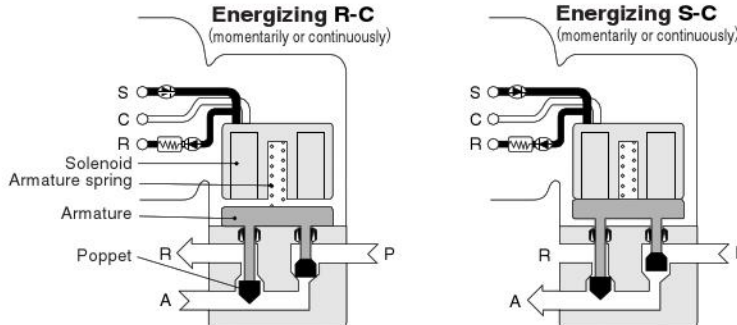
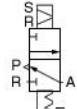

1. When power is supplied to the R-C terminal, the air coming from P is blocked by the poppet at P, and air flows A to R.
2. When power is supplied to the S-C terminal, the P side poppet opens and the R side poppet closes, so that the air flows from P to A.
3. Even if power to the S-C terminal is cut off, a strong residual magnetic force maintains the previous position.
4. When power is supplied to the R-C terminal, the residual magnetic force disappears, and the armature is pushed downward by the armature spring.

For details, see p. 883~884.

Double solenoid type

(E2 type)

Symbol

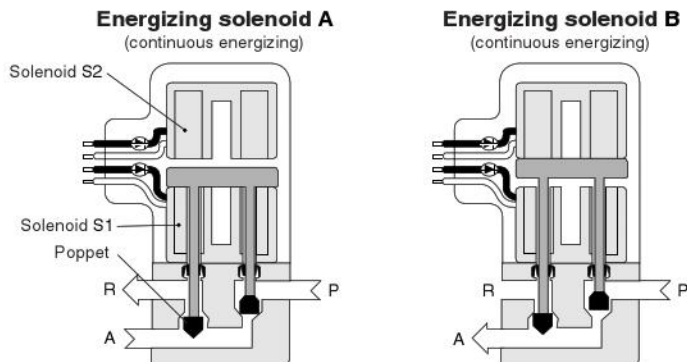
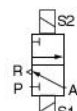

1. When the S1 solenoid is in an energizing condition, the air coming from P is blocked by the poppet at P, and air flows from A to R. This condition is firmly maintained by the air pressure applied to the poppet at P.
2. When the S2 solenoid is energized, the P side poppet opens and the R side poppet closes, so that the air flows from P to A. This condition is firmly maintained by the air pressure applied to the poppet at R.
3. While the solenoid is "momentarily energizing holding type" increasing residual magnetism in addition to the normal continuously energizing type, air pressure applied to the poppet guarantees the holding position in the case, as well.

Voltage Types and Current

Single solenoid (E1) and double solenoid (E2) type

Rated voltage V	Current mA (The starting current and energizing current are virtually identical, and are within these values.)		Color of lead wire	
	50Hz			
	50Hz	60Hz		
AC	230 ^{※1}	63	55	White, black
	220 ^{※1}	58	72	
	200	70	65	
	115 ^{※1}	130	110	Yellow, black
	110 ^{※1}	120	160	
	100	140	130	
	DC	48 ^{※1}	410	370
24 ^{※1}		930	830	
200 ^{※2}		48		White, black
110 ^{※2}		80		Yellow, black
100 ^{※2}		90		
DC	48 ^{※2}	190		Red, black
	24	400		
	12 ^{※2}	750		
	6 ^{※2}	1500		

- Notes: 1. For items with ※1, specify the frequency and consult us for the delivery.
 2. For ※2 items, consult us for the delivery.
 3. This table is also applicable to the 3-position solenoid valves 253, 503, and 753 types.
 4. For explosion proof solenoid valves, see p. 934.
 5. The return current will vary depending on the rated voltage, but in the range of 20~2mA.

Keep solenoid (SE2) type

Rated voltage V	Current mA (The starting current and energizing current are virtually identical, and are within these values.)			Color of lead wire
	50Hz			
	50Hz	60Hz	70	
AC	200	80	70	White, black, red Yellow, black, red
	100	180	160	

Wiring Instructions

Single solenoid (E1) type

- When connecting 2 or more valves in parallel, use the black lead wire for common connections of the AC type. A diode is connected to the black lead wire for the AC type. No diode is in the DC type, so the wiring has no polarity.

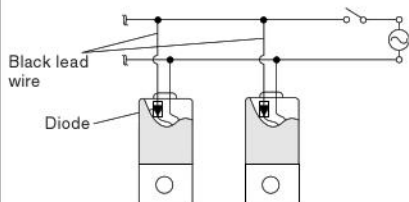

Keep solenoid (SE2) type

- For the 2, 3-port valve, energizing the S1 solenoid in the diagram (the set side) opens the valve, while energizing the S2 solenoid (reset side) closes it. For the 4, 5-port valve, energizing the S1 solenoid opens the A port, while energizing the S2 solenoid opens the B port.
- For connections of 2 or more valves in parallel, or for instructions for wiring connections with other inductive loads, see p.883.
- The minimum time to energize for operation is 50ms.

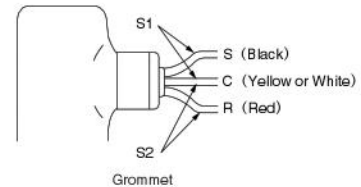
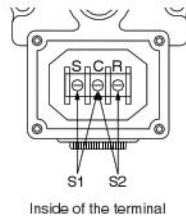

Double solenoid (E2) type (continuously energizing holding type)

- When connecting 2 or more valves in parallel, use the black lead wire for common connections of the AC type. A diode is connected to the black lead wire for the AC type. No diode is in the DC type, so the wiring has no polarity.

- Two solenoids, an upper and lower, are built into this valve. They are color-coded with vinyl tape.

For the 2, 3-port valve, energizing the red tape side (for units with terminals, the S2 side in the diagram) opens the valve, while energizing the non-tape side (for units with terminals, the S1 side in the diagram) closes the valve.

For the 4, 5-port valve, energizing the red tape side (for units with terminals, the S2 side in the diagram) opens the A port, while energizing the non-tape side (for units with terminals, the S1 side in the diagram) opens the B port.

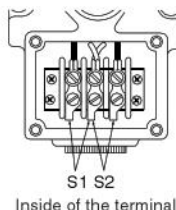
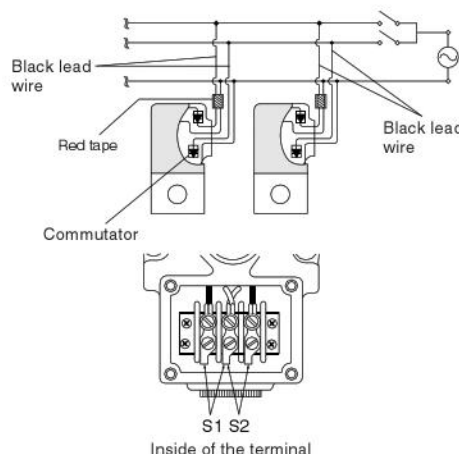

Double solenoid (E2-D) type (momentarily energizing holding type)

- No diode is equipped with either the AC or DC type, so the wiring connections have no polarity.
- The lead wire color coding and instructions of terminal connections are the same as for the continuously energizing holding type.
- While the energizing time required for switching the valve is about 50ms, air pressure is required to maintain that condition. For this reason, continue energizing until exhaust is complete (or when operating a cylinder, until the operation is complete). Hold the continuous energizing time to 5 minutes or less, and ensure that the de-energized period is longer than the energizing time.

Explanation of Keep Solenoid

Features

While the conventional self-holding type solenoid valve employs 2 solenoids, this keep solenoid type achieves the same operation with just 1 solenoid.

Can firmly maintain both the ON and OFF positions with just momentary energizing.

Holding force is strong, achieving superior vibration and shock resistance in any directions.

Vibration resistance is more than $107.9\text{m/s}^2\{11\text{G}\}$ and shock resistance is more than $294.2\sim 392.3\text{m/s}^2\{30\sim 40\text{G}\}$ for the direct acting type, and $980.7\text{m/s}^2\{100\text{G}\}$ for the indirect acting type. (Shock resistance for the ordinary microswitch is about $294.2\text{m/s}^2\{30\text{G}\}$, and about $49.0\sim 196.1\text{m/s}^2\{5\sim 20\text{G}\}$ for the relay.)

No need to worry about burning even with continuous energizing.

Moreover, burning will not occur even if the set signal and reset signal are applied at the same time.

Construction and operation

The diagrams show the direct acting type (or pilot section for the indirect acting valve).

Operation under the set signal

When the ON signal is excited (for 0.05s or more) to the S-C (set side) terminal, as shown in Fig. 1, the solenoid is energized by half-wave rectification, and the armature is attracted (the direction of current flow and the magnetic poles are as shown in the diagram). Then, the armature keeps its position by residual magnetic force even after the ON signal is turned off.

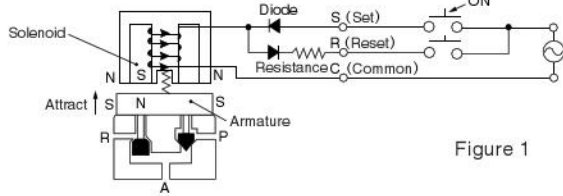

Figure 1

Operation under the reset signal

When the OFF signal is excited (for 0.05s or more) to the R-C (reset side) terminal, as shown in Fig. 2, the current reduced by resistance flows in the direction opposite to the set direction, the residual magnetic force suddenly vanishes, and the armature is returned to its position by a spring. In other words, turning this solenoid valve ON and OFF is achieved by momentary energizing alternately to S-C and R-C.

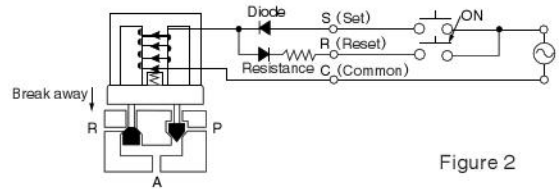

Figure 2

Wiring instructions

When activating 2 or more valves simultaneously

When the ON and OFF operations are reversed, use different connections to link the S and R terminals, as shown in the diagram at the left. When the S and R terminals are connected into their same respective phases, there is no limit to the number of units that can be connected in parallel.

<The reason>

When the A-1 contact is turned on, current flows along the R-C on Valve 1 and the S-C on Valve 2, and they are both activated normally. The C side is the positive (+), however, the current flows along the dotted lines and causes resets or vibrations, even when a set signal has been excited to valve 2.

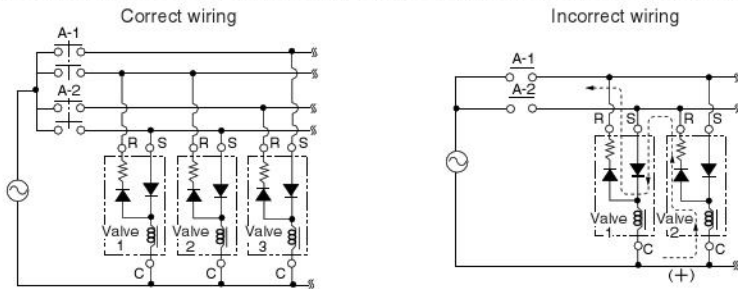

When using a neon lamp

Install a diode and a surge absorber on the R (reset) side, as shown in the diagram.

Use the diode, with which dielectric voltage is about 3 times as high as the power voltage. If the diode is not installed, or if it is connected in the wrong direction, both neon lamps will light up when the set signal is excited.

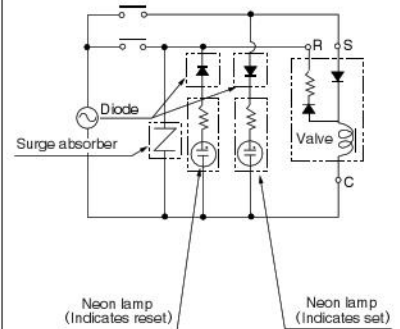

When connecting inductive loads for other than the SE2 type in parallel

Connect at separate contacts, as shown in the diagram.

<The reason>

Switching the A-1 contact ON and OFF is normal operation. If, however, current is sent along the dotted line to the inductive load side when the A-2 contact is ON, there may be insufficient current on the reset side, and reset may be impossible.

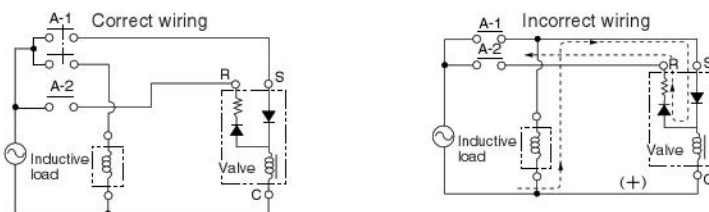

Precautions (Keep solenoid)

1. Note that the keep solenoid valve cannot be used with solid state type relays with leakage current.
Because the solenoid's reset current is so small that the relay leakage current alone can reset the solenoid after it has been set.
2. Note that exciting the set and reset signals at the same time can cause vibrations.
3. While the valves work under normal usage and environments in most applications, avoid using in locations subject to harsh vibrations or to strong magnetic fields.
4. While the direct acting type maintains the ON or OFF position regardless of the presence or absence of an air supply, caution should be exercised that the indirect acting type switches the stem to the OFF position when the air supply is cut off.
5. Use a fingertip to operate the manual override. Note that the manual override will not activate when the valve is set to the ON position. Operate the manual override after exciting the reset signal to demagnetize and set the reset signal to OFF, such as in a test operation .

Safety Precautions (Round type series solenoid valves and explosion proof solenoid valves)



- Warning**
1. When mounting a valve inside the control panels or when an operation requires long energizing periods, provide heat radiation measures to ensure that the ambient temperature always remains within the temperature range specifications. For long-term continuous energizing, consult us.
 2. Always check the Catalog, etc., when carrying out wiring and piping of products to ensure that the connections are correctly done. Wrong wiring or piping could result in abnormal operation to the actuator, etc.
 3. The solenoid valve's silicon diode could be damaged by surge voltage when a large inductive load is used on the same power supply. Either change to a separate power supply, or install a surge absorber to protect the unit. Solenoids with surge suppression are also available. Consult us.



- Caution**
- For locations subject to water or to large amounts of dust, use a cover, etc., to protect the valves. Also, attach a muffler, etc., to the R port to prevent dust from entering. Entering water or dust could result in short-term functional shutdowns, sudden drops in performance, or a reduced operating life.



- Attention**
1. Use clean air that does not contain degraded compressor oil, etc. and install a filter, etc., close to solenoid valves to remove dust or collected liquid.
 2. Ensure that the piping port on the supply side has at the same area or larger than the solenoid valve's effective area.
 3. When using an indirect acting valve, use a stop valve between it and the pressure source. When the stop valve is opened before the pressure reaches the minimum operating pressure, the indirect acting valve could fall into a neutral position. (All solenoid valves in the 250 series and up are indirect acting valves.)
 4. When connecting 2 or more AC type solenoid valves to the same power supply, connect the same color lead wires.
 5. Since a diode is equipped with the AC type solenoid valve, the solenoid may sometimes not turn on with the solid state-type relay (SSR) with zero-cross function. For this reason, pay attention before use to the ratings and precautions for use of the solid state-type relay.



- Others**
- In the Catalog, Class 1 of the recommended oil "Turbine Oil Class 1 (ISO VG32)" signifies "non-additive," while VG32 signifies "viscosity." The previous notation of "Turbine Oil #90" has been changed.

Construction of Manual Override

		Single solenoid (E1)			
		Non-locking type		Locking type	
		Normally closed (NC)	Normally open (NO)	Normally closed (NC)	Normally open (NO)
Construction					
		<p>Pressing the button with a fingertip turns it on, and releasing the button turns it off.</p>		<p>Using a screwdriver to press the button turns it on, and releasing the button turns it off. Lock it by pressing in and then turning it by 90 degrees (to align with the groove outside). After operation, always release the lock.</p>	
Operation type					
Construction					
		<p>Pressing the button turns it on, and releasing the button turns it off. When set as ON, the manual override cannot be operated. To perform test operations, etc., reset to the OFF position before starting.</p> <p>●Caution The following operation causes the ON position to continue, and the manual override cannot be used to turn the valve OFF. 1. When the manual override is in the ON position, and reset voltage or set voltage is applied. 2. When the manual override is operated while the reset voltage or set voltage has been applied. In this condition, applying the set voltage once, and applying the reset voltage later, allows the manual override to be operated again.</p>		<p>Remove the cap and pull the manual override button with a finger to turn it on, and press it to turn it off. While the manual override has no locking mechanism, the air-pressure holding force maintains the position.</p>	
Operation type					

Note: The 3-position solenoid valve manual override has the same construction as the one for the single solenoid normally open type (E1, NO).

Mounting and Adjusting of Manual Override

Non-locking type

Adjusting procedures

1. Screw in nut (A) into the support.

Screw in nut (A) until it contacts the cam, then return back one-half to one full rotation from that position.

(In the one-half to one full rotation back position, confirm that some play with the cam exists.)

2. Align slotted groove on the base to the nut (A) slot.

When it is not aligned to the slot, loosen nut (A) and realign it.

3. Use nut (B) to lock.

Insert a screwdriver into the aligned groove, and lock it so that it cannot rotate.

Do not tighten more than needed.

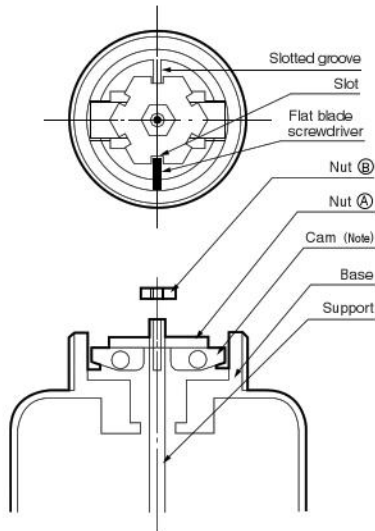

Note: Place the cam under the side with the black mark.

Locking type

Adjusting procedures

The procedure for adjusting nuts (A) and (B) is the same as for the non-locking type.

1. Align the slotted groove of the manual override button to the groove of the adjusting screw, and use a screwdriver to screw in the manual override button and the adjusting screw at the same time.

Screwing them in causes air to leak, in the case of the direct acting valve, from the R port, and in the case of the indirect acting valve, from the PR port. Keep screwing in further, until the air stops leaking.

2. From the position where the air stops leaking, screw in a further 10 degrees. Do not screw in more than needed.

3. Use nut (C) to lock the adjusting screw.

Lock it with a screwdriver inserted condition.

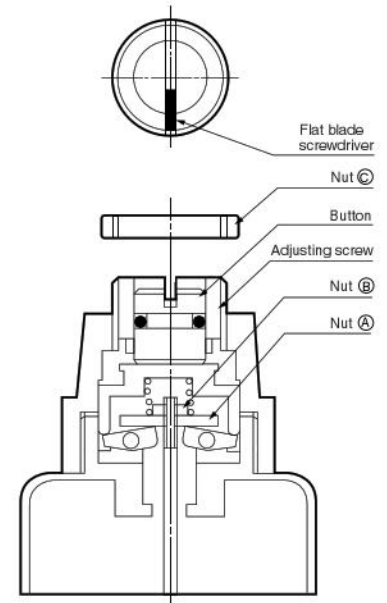

SOLENOID VALVES 126 SERIES

Direct acting 2-port

Symbols

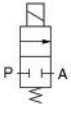
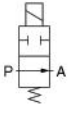
NC	NO
	
126E1	126E1-11

Basic Models and Valve Functions

Item	Model	126E1	126E1-11
Number of positions		2	
Number of ports		2	
Valve function		Single solenoid	
		Normally closed (NC, standard)	Normally open (NO, optional)

Specifications

Item	Model	126E1	126E1-11
Media		Air	
Operation type		Direct acting type	
Effective area [Cv]	mm ²	5.5 [0.27]	
Port size	Rc	1/4	
Lubrication		Not required	
Operating pressure range	MPa [kgf/cm ²] [psi.]	0~0.5 [0~5.1] [0~73]	
Proof pressure	MPa [kgf/cm ²] [psi.]	0.75 [7.7] [109]	
Response time	ms	30	
	ON/OFF	ON	OFF
Maximum operating frequency	Hz	4	
Minimum time to energize for self holding	ms	—	
Operating temperature range (atmosphere and media)	°C [°F]	0~60 [32~140]	
Mounting direction		Any	
Mass	kg [lb.]	0.3 [0.66]	

Solenoid Specifications

Item	Solenoid type	Single solenoid (E1)
Voltage type	V	See the Voltage Types and Current.
Voltage range	%	Rated voltage $\pm 10\%$
Current	mA	See the Voltage Types and Current.
Energizing type		Continuously energizing type
Insulation type		B type
Wiring type		Grommet type
Lead wire length	mm [in.]	Approximately 300 [11.8]

Inner Construction and Major Parts

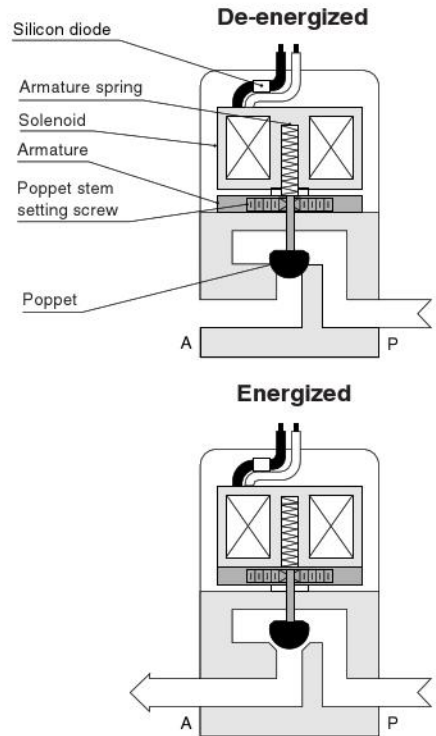

Flow Rate

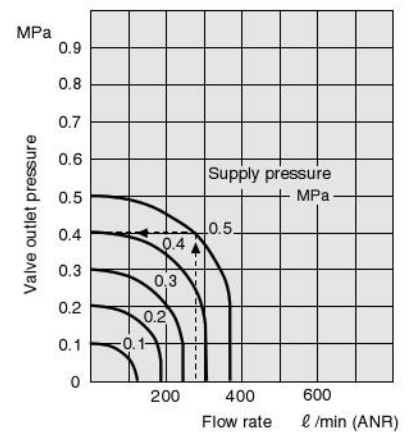

How to read the graph

When the supply pressure is 0.5MPa [73psi.] and the flow rate is 275 ℓ /min [9.71ft³/min.] (ANR), the valve outlet pressure becomes 0.4MPa [58psi.]. 1MPa = 145psi., 1 ℓ /min = 0.0353ft³/min.

Manifold

Manifold base is shared with the 062 series. See p.894.

Major Parts and Materials

Parts	Materials
Body	Aluminum alloy (anodized)
Poppet stem	Brass
Poppet	Synthetic rubber
Seal	

Order Codes

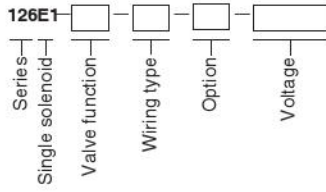

Valve function

Code	Specifications
Blank	NC (normally closed)
11	NO (normally open)

Option

Code	Specification
21	With mounting base

Wiring type

Code	Specifications
Blank	Grommet
37	Conduit
T	With terminal box

Voltage

Code	Specifications
AC100V	AC100V 50/60HZ
AC200V	AC200V 50/60HZ
DC24V	DC24V

See notes 1 and 2.
For other voltages, see p.882.

Notes: 1. Also specify Hz for AC110V and 220V.
2. For the order code, first enter numbers, in order from small to large, and then enter alphabetic characters.

Example: **126E1-21-AC100V**

● Standard type 126E1

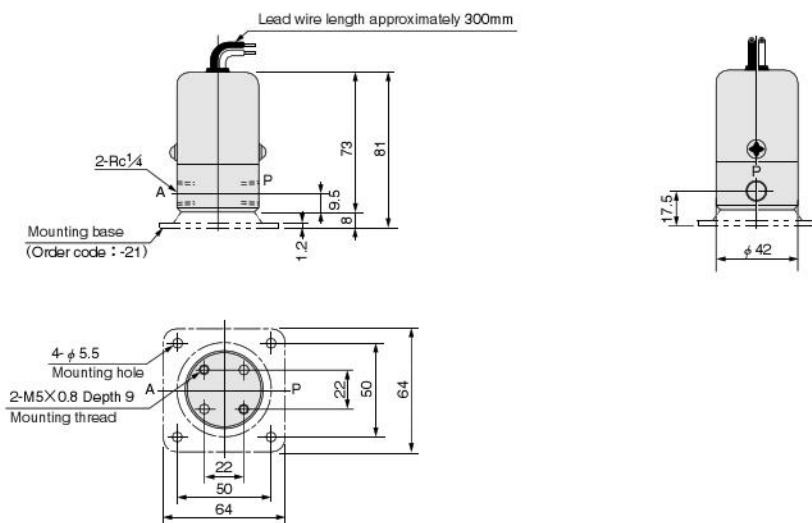

● With conduit cover 126E1-37

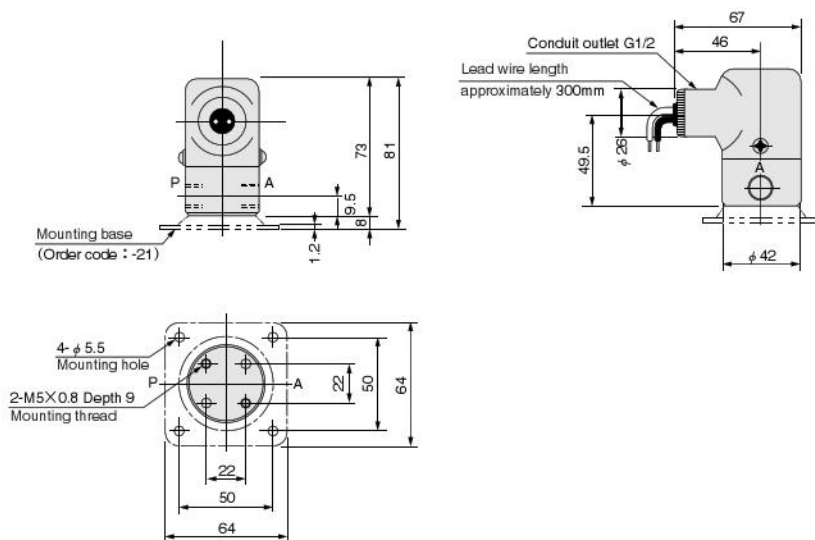

● With terminal box 126E1-T

